

Riverview Asset Annual Review Application

Applicant:

Riverview Asset

Project and Request:

Application for Annual Review

Presented To:

Clark County

Submitted:

January 30, 2019

Applicant's Representative:

Jamie Howsley

jamie.howsley@jordanramis.com

Armand Resto-Spotts

armand.resto-spotts@jordanrams.com

(360) 567-3900

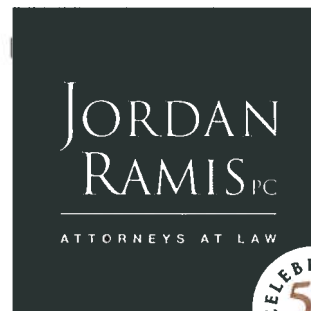

TABLE OF CONTENTS

Application	1
Legal Description	2
Copy of Pre-Application Report (PAC2018-00131)	3
Developer’s GIS Packet	4
SEPA Checklist	5
Narrative	6
Traffic Impact Study Report	A
Market Analysis Report	B
Map of Vacant Industrial Land	C
Excerpt from 12/13/16 Pre-App Conf Rpt.....	D

Development Application

Project name: Riverview Asset Application for Annual Review		
Type(s) of application (see reverse side): Annual Review		
Description of proposal: Annual Review and Zone Change Applications		
Applicant name: James D. Howsley Armand Resto-Spotts	Address: 1499 SE Tech Center Place, Ste 380 Vancouver, WA 98683	
E-mail address: jamie.howsley@jordanramis.com armand.resto-spotts@jordanramis.com	Phone and fax: 360-567-3900	
Property owner name (list multiple owners on a separate sheet): Riverview Asset Management & Trust et al. Trustees	Address: c/o Dempsey Family Trust 900 Washington Street, Ste 900 Vancouver, WA 98660	
E-mail address: Contact Applicant	Phone and fax: Contact Applicant	
Contact person name (list if not same as applicant): Contact Applicant	Address:	
E-mail address: Contact Applicant	Phone and fax:	
Project site information: Site address: 10512 NE 152nd Avenue Vancouver, WA 98683	Comp plan designation: 1	
Cross street:	Zoning: BP	Parcel numbers: 200326000; 200355000
Overlay zones: N/A	Legal: See Attached	Acreage of original parcels: 69.55
Township: 3N	Range: 2E	1/4 of section: SE

Authorization

The undersigned hereby certifies that this application has been made with the consent of the lawful property owner(s) and that all information submitted with this application is complete and correct. False statements, errors, and/or omissions may be sufficient cause for denial of the request. This application gives consent to the county to enter the properties listed above.

 1-29-19
Applicant's signature Date

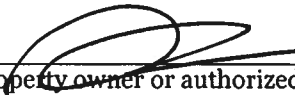
 1-29-19
Property owner or authorized representative's signature Date

For staff use only	Case number:	Work order number:
---------------------------	--------------	--------------------

Revised 6/14/12



Community Development
1300 Franklin Street, Vancouver, Washington
Phone: (360) 397-2375 Fax: (360) 397-2011
www.clark.wa.gov/development



For an alternate format, contact the Clark County ADA Compliance Office.
Phone: (360)397-2322
Relay: 711 or (800) 833-6384
E-mail: ADA@clark.wa.gov

Application types

If you have any questions regarding the type of application being requested, our Permit Technicians will be happy to assist you.

- Annual Review
- Appeal
- Boundary Line Adjustment and Lot Reconfiguration
- Conditional Use

Environmental/Critical Areas

- Critical Aquifer Recharge Area (CARA)
- Columbia River Gorge
- Forestry + (Moratorium Waiver, Moratorium Removal, Class I, Class IVG or COHP)
- Floodplain
- Geological
- Habitat
- Habitat Monitoring
- Historic
- SEPA
- Shoreline
- Wetland
- Wetland Monitoring

Land Division

- Binding Site Plan
- Final Plat
- Plat Alteration
- Short Plat (___ Infill)
- Subdivision (___ Infill)

Miscellaneous

- Addressing
- Accessory Dwelling
- Covenant Release
- Home Business
- Legal Lot Determination and Innocent Purchasers Determination
- Non-Conforming Use Determination
- Sewer Waiver
- Shooting Range
- Sign

Planning Director Review

- Post Decision
- Pre-Application Conference
- Pre-Application Waiver
- Public Interest Exception
- Similar Use
- Temporary Use
- Planned Unit Develop/Master Plan
- Road Modification
- Site Plan
- Variance
- Zone Change

EXHIBIT "A"

Legal Descriptions
APN 200326000 and 200355000

The North 1,760 feet of the East 1,980 feet of the Southeast Quarter of Section 35, Township 3 North, Range 2 East.

TOGETHER WITH AND SUBJECT TO covenants, restrictions, easements, conditions, and reservations of record.

EXCEPT

A PARCEL OF PROPERTY IN THE SOUTHEAST QUARTER OF SECTION 35, TOWNSHIP 3 NORTH, RANGE 2 EAST, OF THE WILLAMETTE MERIDIAN, IN CLARK COUNTY, WASHINGTON DESCRIBED AS FOLLOWS:

COMMENCING AT THE SOUTHEAST CORNER OF SAID SOUTHEAST QUARTER;

THENCE NORTH 01°50'04" EAST ALONG THE EAST LINE OF SAID QUARTER 880.00 FEET TO THE NORTHEAST CORNER OF THE WESTERLY PORTION OF THE PLAT OF MISTY MEADOWS ESTATES RECORDED IN PLAT BOOK 311, PAGE 412, RECORDS OF CLARK COUNTY;

THENCE NORTH 89°34'59" WEST ALONG THE NORTH LINE OF SAID PLAT AND THE WESTERLY PROJECTION OF SAID NORTH LINE 1977.96 FEET TO THE NORTHWEST CORNER OF THE PLAT OF CHERRY PARK RECORDED IN PLAT BOOK 310, PAGE 833, RECORDS OF CLARK COUNTY AND THE TRUE POINT OF BEGINNING;

THENCE SOUTH 89°34'59" EAST ALONG THE NORTH LINE OF SAID PLAT 947.94 FEET;

THENCE NORTH 01°50'04" EAST 914.22 FEET;

THENCE NORTH 89°34'59" WEST 964.55 FEET TO THE NORTHEAST CORNER OF THE PLAT OF FALCON'S NEST RECORDED IN PLAT BOOK 311, PAGE 614, RECORDS OF CLARK COUNTY;

THENCE SOUTH 01°55'01" WEST ALONG THE EAST LINE OF SAID PLAT 499.00 FEET TO AN ANGLE POINT IN SAID EAST LINE;

THENCE SOUTH 88°04'55" EAST ALONG SAID EAST LINE 21.17 FEET TO AN ANGLE POINT;

THENCE SOUTH 00°12'00" WEST ALONG SAID EAST LINE 80.25 FEET TO AN ANGLE POINT;

THENCE SOUTH 03°04'00" WEST ALONG SAID EAST LINE 260.70 FEET TO AN ANGLE POINT;

THENCE SOUTH 02°14'00" WEST ALONG SAID EAST LINE 73.92 FEET TO THE TRUE POINT OF BEGINNING.

TOGETHER WITH that certain Easement as contained in that certain Bargain and Sale Deed With Easement Reserved dated September 14, 2016, and recorded under Clark County Auditor's File No. 5325415.

SUBJECT TO that certain Road Easement Agreement dated September 14, 2016, and recorded under Clark County Auditor's File No. 5325416.



Pre-Application
Conference
FINAL Report

Project Name:	Riverview Asset
Case Number:	PAC2018-00131
Location:	10512 NE 152nd Ave, Vancouver, WA, 98682. SE Quarter of Section 35, Township 3 North, Range 2 East of the Willamette Meridian.
Parcel Number(s):	200326000; 200355000
Site Size:	69.55 acres
Request:	A request to amend the Comprehensive Plan and Zoning Maps on two parcels (200326000 and 200355000) from Industrial (Business Park (BP)) to Urban Low Density Residential (R1-10), and from Industrial (Business Park (BP)) to Community Commercial (CC) zoning along the frontage of the property along NE 152 nd Ave. Parcel (200305000) may also be included in the proposal.
Applicant:	Jamie Howsley 1499 SE Tech Center Pl, Ste 380 Vancouver, WA 98683 (360) 567-3900 Jamie.howsley@jordanramis.com
Contact Person:	Jamie Howsley 1499 SE Tech Center Pl, Ste 380 Vancouver, WA 98683 (360) 567-3900 Jamie.howsley@jordanramis.com
Property Owner:	River Trust Company c/o Dempsey Family Trust 900 Washington St., Ste. 900 Vancouver, WA 98660

DATE OF CONFERENCE: December 4, 2018

STAFF CONTACT: Sharon Lumbantobing, Clark County Annual Review Coordinator
(564) 397-4909 Sharon.Lumbantobing@clark.wa.gov

PRESENT AT CONFERENCE:

Name	Contact Information
Sharon Lumbantobing	Clark County Community Planning (see above)
Jose Alvarez	Clark County Community Planning, (564) 397- 4898
Gary Albrecht	Clark County Community Planning, (564) 397- 4318
Armand Resto-Spotts	Applicant (360) 567-3900
Jamie Howsley	Applicant (360) 567-3900

Disclaimer: The following is a brief summary of issues and requirements that were identified at the pre-application conference based on the information provided by the applicant. This summary may contain supplemental information which was not discussed in the conference and is intended to aid the applicant in preparing a complete Annual Review application and/or to provide the applicant with additional information regarding the subject site. Staff responses and information contained in this pre-application report are preliminary in nature, and do not constitute an approval or denial. The determinations contained in this report were based upon information submitted by the applicant, and may be subject to change upon further examination or in light of new or revised information contained in the formal application.

APPLICATIONS REQUIRED

The requested Comprehensive Plan map and concurrent zone map amendments require an Annual Review/Zone Change Application to be completed. The application will be processed through the Type IV Review process. A SEPA checklist is required to be completed as a part of the Annual Review application.

Estimated fees:*

Combined Annual Review/Rezone.....	\$8,113.00
Issuance Fee.....	\$94.00
Environmental Checklist Review (SEPA).....	\$1,987.00
Issuance Fee.....	\$53.00

***Fees cited are estimated and based upon the fee schedule in effect at the time of pre-application conference and are subject to change.**

APPLICABLE POLICIES, CODES and CRITERIA

The following list is not exhaustive of all county, state or federal regulations that may govern development of the site, but is inclusive of those addressed by the county in this comprehensive plan/zone amendment review process.

- WAC 365-196-300
- Clark County 20 Year Comprehensive Growth Management Plan Policies
 - Chapter 1 – Land Use Element
 - Chapter 2 – Housing Element
 - Chapter 9 – Economic Development
 - Chapter 10 – School Element
 - Chapter 11 – Community Design Element
- Clark County Unified Development Code
 - Title 40:
 - Section 40.220 (Urban Residential Districts)
 - Section 40.230 (Commercial Districts)
 - Section 40.500.010 (Procedures)
 - Section 40.560.010 (Plan Amendment Procedures)
 - Section 40.570 (SEPA)

Clark County Criteria for Map Changes (found within the text of this report)

- Section 40.560.010G (Criteria for all Map Changes)
- Section 40.560.020 (Changes to Districts, Amendments, and Alterations)
- Section 40.560.020G (Approval Criteria)

Comprehensive Plan Designation Map Change Criteria

Comprehensive plan designation changes may only be approved if **all** the following criteria are met (40.560.010G):

1. *The proponent shall demonstrate that the proposed amendment is consistent with the Growth Management Act and requirements, the Countywide Planning Policies, the Community Framework Plan, the Comprehensive Growth Management Plan, applicable city comprehensive Plans, and including applicable capital facilities plans and official population growth forecasts; and*
2. *The proponent shall demonstrate that the designation is in conformance with the appropriate location criteria identified in the plan; and*
3. *The map amendment or site is suitable for the proposed designation and there is a lack of appropriately designated alternative sites within the vicinity; and*
4. *The plan map amendment either: (a) responds to a substantial change in conditions applicable to the area within which the subject property lies; (b) better implements applicable Comprehensive Plan policies than the current map designation; or (c) corrects an obvious mapping error; and*
5. *Where applicable, the proponent shall demonstrate that the full range of urban public facilities and services can be adequately provided in an efficient and timely manner to serve the proposed designation. Such services may include water, sewage, storm drainage, transportation, fire protection and schools. Adequacy of services applies only to the specific change site.*

Zone Change Criteria

The concurrent zone change may only be approved if **all** the following criteria are met (40.560.020G):

1. *Requested zone change is consistent with the comprehensive plan map designation.*
2. *The requested zone change is consistent with the plan policies and location criteria and the purpose statement of the zoning district.*
3. *The zone change either:*
 - a. *Responds to a substantial change in conditions applicable to the area within which the subject property lies;*
 - b. *Better implements applicable comprehensive plan policies than the current map designation; or*
 - c. *Corrects an obvious mapping error.*
4. *There are adequate public facilities and services to serve the requested zone change.*

SUBMITTED MATERIALS REVIEWED

The following materials were provided by the applicant and were reviewed by Clark County staff in advance of the pre-application conference:

- Application forms
- Narrative
- GIS Packet

BACKGROUND

The applicant proposes to amend the Comprehensive Plan and Zoning Maps from Industrial (Business Park (BP)) to Community Commercial (CC) zoning along the frontage of the property along NE 152nd Ave, and to Urban Low Density Residential (R1-10) on the rest of the property.

SUMMARY

The following comments and issues were discussed or identified during the pre-application meeting held on December 4, 2018.

Land Use

Comments provided by Clark County Long Range Planning, Sharon Lumbantobing:

Staff provided the applicant with a brief overview of how the pre-application conference would be conducted, including a summary of what information would be covered. Staff stated that a final staff report will be sent to the applicant within a week following the pre-app meeting. Staff stated that January 31 is the deadline to submit an annual review application.

Staff provided information regarding Clark County's obligation to plan under the State's Growth Management Act and the long-range, comprehensive planning exercise that concluded in 1994 with the adoption of the 20-Year Comprehensive Growth Management Plan and corresponding zone map. In 2016, the County adopted an updated 20-Year Comprehensive Plan and zone map.

Staff proceeded to discuss with the applicant the Comprehensive Plan Designation Map Change Criteria that the applicant will need to address in an application. Staff said that the proposal to change the designation will need to be consistent with the Growth Management Act and the county-wide planning policies.

Specific to this application, staff stated that the assumption is that the current comprehensive plan Industrial (I) with Business Park (BP) zoning is still applicable to this area. The applicant will need to demonstrate that a change to Community Commercial (CC) zoning along the frontage of the property along NE 152nd Ave and Urban Low Density Residential (UL) with R1-10 zoning on the rest of the property is appropriate and consistent with the County's Growth Management Plan and Unified Development Code.

Staff emphasized that as the applicant's Annual Review application (CPZ2017-00022 Riverview Asset Trust) was recommended for denial by the Planning Commission and the county council did deny the request, the applicant will need to demonstrate what has changed since that application was submitted.

Staff emphasized that the applicant needs to address how the proposed zoning addresses the loss of job producing land and the loss of Business Park zoning. Business Park zoning is employment land. Given the current economic trends in the county, there is a decline in demand for commercially zoned properties.

Staff stated that the application needs to address Policy 9.3 in the Economic Development Element of the Comprehensive Plan:

Goal: Assure an adequate supply of industrial sites to meet market demands for industrial development over the planning horizon to create an environment conducive to the startup, growth, and expansion of industries.

9.3 Policies

9.3.4 Conversion of industrial or employment lands to non-industrial or non-employment districts may occur within the following parameters:

- a. Protect and preserve lands zoned heavy industrial for heavy industrial uses.
- b. Protect employment lands from conversion to residential.
- c. Consider rezoning of employment lands to non-retail commercial or business park if the proponent can show that (a) the zone change would accommodate unforeseen and rapidly changing commercial development needs and (b) the proposed designation is more suitable than the current designation given the land's site-specific characteristics, and (c) the proposed zone change will generate jobs at a higher density than the current comprehensive plan zone allocation.

(Comp Plan Economic Development Element, p. 228)

Staff stated that it is not clear what the applicant is proposing in terms of how much acreage is proposed to be zoned commercial and where the applicant would put the commercially zoned property. The applicant needs to clarify this.

In 2017, the City of Vancouver submitted a letter in support of the staff recommendation to deny the proposed amendment. The letter cited the potential loss of family wage jobs and the lack of similarly zoned sites in the vicinity. The letter also noted the proposed action would leave a 20-acre parcel to the north with BP zoning which would then be difficult to develop. The CREDC was not supportive of this zone change, without first finding land to replace it.

In December 2018, the City of Vancouver submitted a letter requesting the applicant to submit an economic analysis demonstrating a lack of long-term employment viability as Business Park and other employment zones, especially as the surrounding area is still developing and this may become viable in the future. If the property is to be converted to residential, some portion should be considered for medium density or denser single-family residential to improve housing diversity and affordability in the wider area.

Staff stated that the applicant should confer with the school district on school impacts. The School Element identifies the imbalance between the mix of residential, commercial and industrial land as one of the contributing factors to failed bond measures. The narrative should address how this proposal affects the mix in the Battle Ground School District. The county updated its 20 year comprehensive plan in June 2016 and designated sufficient land for residential growth through 2035. The applicant needs to demonstrate a need for additional residential land.

In 2017, the applicant applied for R 1-6 zoning on these same parcels, which was denied. The applicant needs to address how the proposed R 1-10 zoning better implements applicable comprehensive plan policies than the current zoning (BP) and the proposed R 1-6 zoning, which was denied. The site is surrounded by low density residential zoning, primarily R1-5 zoning. The applicant needs to demonstrate a lack of appropriately designated residential land within the vicinity.

Staff stated that the applicant should confer with the neighborhood association.

Transportation

Comments provided by Clark County Long Range Planning, Gary Albrecht:

NE 152nd Street is classified as a two-lane collector or C-2 with a 60' right-of-way and 38' paved width. The cross-section includes two travel lanes, parking and sidewalks on both sides.

Staff reviewed the six-year Transportation Improvement Program, 2018 - 2023 and found one project that would impact the area immediately around the site of the proposed comprehensive plan amendment and zone change. NE 152nd Avenue will improve a 2-lane collector with bike lanes and sidewalks from Padden Parkway to NE 99th Street.

More information is needed to complete a transportation analysis. How many acres of Community Commercial (CC) and Urban Low Density Residential (R1-10) will be created?

Applicant needs to submit preliminary PM peak trip generation to determine the scope of work based on CCC 40.350.020 (D) (5).

Criteria for annual review transportation analysis

Transportation analysis

To meet the requirements of Clark County Title 40 code section 40.560.010, the applicant must show that adequate transportation facilities will be available to accommodate the proposed comprehensive plan amendment, which is why a transportation analysis is needed for applications for comprehensive plan amendments. The specific language states the following:

Where applicable, the proponent shall demonstrate that the full range of urban public facilities and services can be adequately provided in an efficient and timely manner to serve the proposed designation. Such services may include water, sewage, storm drainage, transportation, fire protection and schools. Adequacy of services applies only to the specific change site.

A transportation analysis is defined per Clark County Title 40 code section 40.100.070 (Definitions) as a study done by a licensed engineer that compares a build-out scenario under the existing and proposed designations for a twenty (20) year horizon

For the proposed comprehensive plan amendment application, the transportation analysis must include the following:

Existing and proposed comprehensive plan designation:

- Trip generation-present day
- Trip generation-projected 20-years
- Modal split-present day
- Modal split-projected 20-years
- Trip distribution-present day
- Trip distribution-projected 20-years

Net comparison (proposed comprehensive plan designation-existing comprehensive plan designation)

The applicant must show the Level-of-Service standards, per CCC 40.350.020.G.1.a-d, under the existing and proposed land use designations for both current and projected 20 years out

NEIGHBORHOOD ASSOCIATION CONTACT

While not required of a complete application for a comprehensive plan amendment, staff recommended that the applicant talk to the neighborhood association chair for their area. The Greater Brush Prairie Neighborhood Association Vice-President is Ray Steiger at greaterbrushprairie@gmail.com Staff also encouraged the applicant to discuss the proposed land use designation change with neighbors.

TIME FRAMES

January 1 through January 31 - Submit Final Annual Review Application

February 1 through to April 1 – Clark County staff will review and prepare a recommendation to the Planning Commission (**this period may be extended depending on staff work load**)

Fourth Quarter or sooner - Planning Commission will approve or deny request. Staff forwards all recommendations to the county council for final resolution of the requests.

ADDITIONAL MATERIALS

A complete list of required documents is contained in the Annual Review application packet. A Completed SEPA checklist is required for the final application. **NOTE: Submit a copy of this summary with your final application.**



December 3, 2018

Sharon Lumbantobing, Clark County Community Planning

Subject: Pre-applications for 2019 Clark County Comprehensive Plan Map Amendments located in the Vancouver Urban Growth Area

Dear Sharon:

We appreciate the opportunity to comment on proposals located in the Vancouver UGA, as many may be annexed in the future, and even outside of annexation may have implications to City public services, or employment and housing markets. Our comments on this year's map change pre-applications are limited to the two proposing conversions of potential shopping or employment land to single-family residential designations in the North Orchards area:

1. 152nd Avenue TSR – Community Commercial to Single Family Residential R1-5 on 7.7 acres at NE 152nd Avenue and 93rd Street

This site appears to be the only commercially zoned property within a half-mile radius, and one of the few anywhere in Vancouver UGA east of 137th Avenue. We would recommend that an application to convert to other uses should include an economic analysis demonstrating the property is not viable for long term commercial development.

If the property is to be converted to residential, we would suggest that some portion of the site be considered for a multi-family or denser single family designation. The eastern Vancouver UGA also appears to contain little existing higher density housing, or zoning that would allow it. Recent proposals such as the new Howard pre-application requesting R-18 zoning north of 119th Street demonstrate some level of market acceptance of modest density elsewhere in the VUGA far from urban centers. Something similar may be appropriate at this site, and would improve housing diversity and affordability in the wider area.

2. Riverview Asset Management – Business Park to R-10 and CC on 160 acres at 152nd Avenue north of 102nd Street.

This site also provided relatively unique employment opportunities in the eastern VUGA, and at 160 acres is large enough to potentially have regional significance. We would strongly recommend that an application to convert this property to residential include an economic analysis demonstrating a lack of long term employment viability. The fact that the property has not

developed to date under the current BP zone is relevant, but it does not answer questions about the viability of other employment zones, or long term viability under BP given that much of the surrounding area is still developing.

If the property is to be converted to residential, we would also suggest that some portion be considered for a multi-family or denser single family designation, for the same reasons cited in the previous comments on the TSR property. In our experience even a denser single family designation can have significant impacts on housing affordability. The 2011 Vancouver Comprehensive Plan indicates that the difference in median assessed values of single family homes in the R1-10 and R1-5 zones in the VUGA was almost \$100,000 in 2011, and the difference is probably greater today (See Comprehensive Plan Table 3-4, page 3-5).

We have no concerns if a portion of the proposal site fronting 152nd Avenue is zoned commercial as suggested in the application, or if the adjacent Battle Ground School District property outside the proposal is rezoned as part of a school development.

Thank you again for the opportunity to comment.

Sincerely,

A handwritten signature in black ink, appearing to read "Bryan Snodgrass".

Bryan Snodgrass, Principal Planner
Community and Economic Development Department
bryan.snodgrass@cityofvancouver.us

DEVELOPER'S PACKET

Produced By:

Clark County Geographic Information System (GIS)



For:

Jordan Ramis, PC

Subject Property Account Number(s):

200355000

200326000

PDF # 220816

Printed: March 21, 2019

Expires: March 20, 2020

Table of Contents

General Location	1
Property Information Fact Sheet	2
Elevation Contours	3
2016 Aerial Photography	4
2016 Aerial Photography with Elevation Contours	5
Zoning Designations	6
Comprehensive Plan Designations	7
Arterials, C-Tran Bus Routes, Parks & Trails	8
Water, Sewer, and Storm Systems	9
Water Systems	10
Hydrant Fire Flow Details	11
Soil Types	12
Environmental Constraints I	13
Environmental Constraints II	14
Adjacent Development	15
Quarter Section Parcels	16

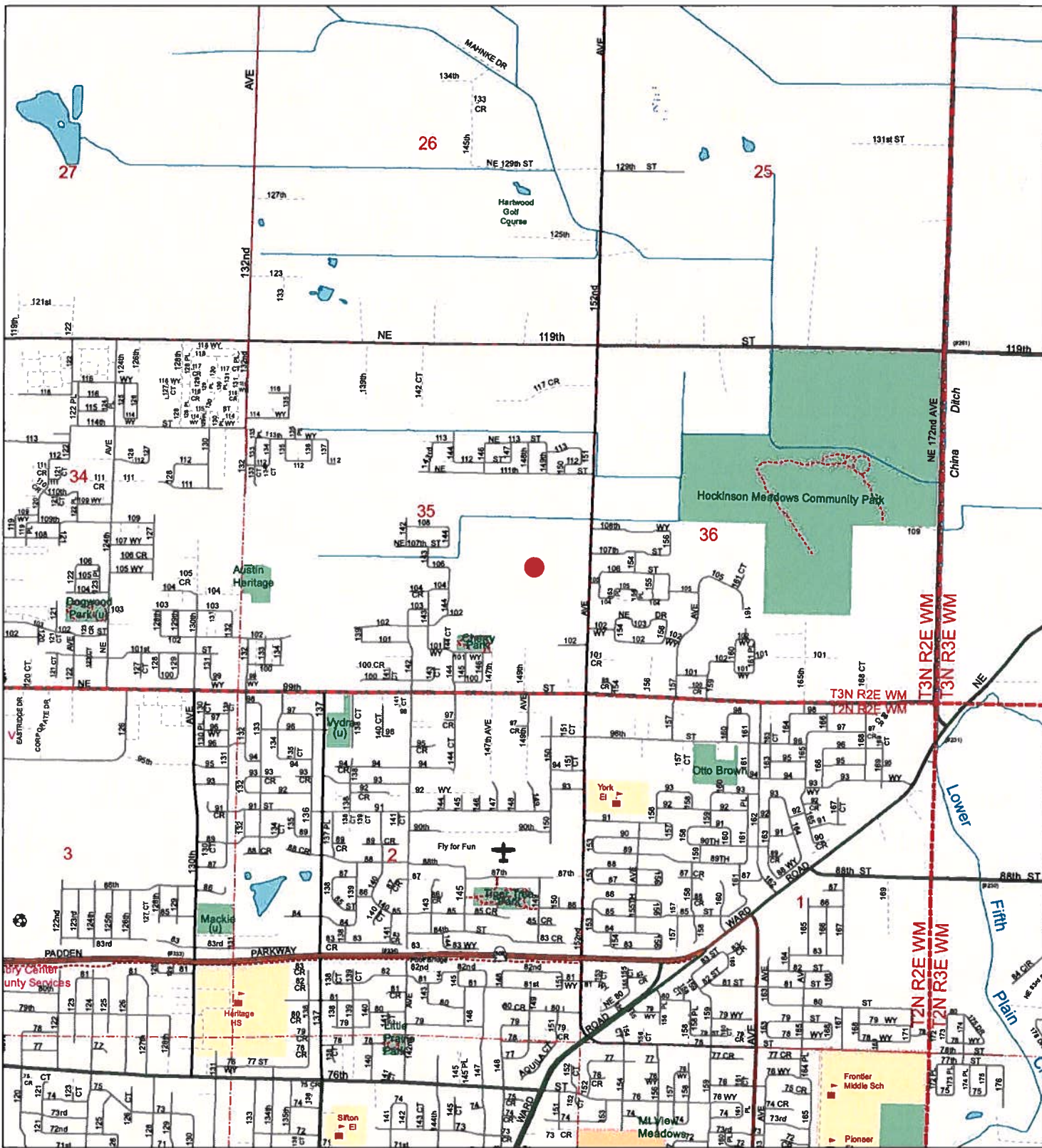

General Location

Printed on: March 21, 2019

Account: 200355000, 200326000
 Owner: WELLS MARY ELLEN & DEMPSEY DIANNE M
 Address: 12502 NE 359TH ST
 C/S/Z: LACENTER, WA 98629

● Location of Subject Property(s)



Geographic Information System

0 1,000 2,000 Feet

Information shown on this map was collected from several sources. Clark County accepts no responsibility for any inaccuracies that may be present.

Property Information Fact Sheet

Mailing Information:

Account No.: 200355000, 200326000
Owner: WELLS MARY ELLEN & DEMPSEY DIANNE M
Address: 12502 NE 359TH ST
C/S/Z: LACENTER, WA 98629

Assessed Parcel Size: 60.13 Ac

Property Type: Multiple Property Types

PARCEL LOCATION FINDINGS:

Quarter Section(s): SE 1/4,S35,T3N,R2E

Municipal Jurisdiction: Clark County

Urban Growth Area: Vancouver

Zoning: BP

Zoning Overlay: No Mapping Indicators

Comprehensive Plan Designation: I

Columbia River Gorge NSA: No Mapping Indicators

Late-Comer Area: No Mapping Indicators

Trans. Impact Fee Area: Orchards: Current,

North Orchards: End Date Dec. 31, 2016

Park Impact Fee District: 5

Neighborhood Association: Greater Brush Prairie

School District: Battle Ground

Elementary School: Maple Grove K-4

Junior High School: Laurin

Senior High School: Prairie

Fire District: FD 5

Sewer District: ClarkRegional

Water District: Vancouver

Wildland: No Mapping Indicators

ENVIRONMENTAL CONSTRAINTS:

Soil Type(s): DoB, 12.5% of parcel

LeB, 60.0%

LgB, 0.2%

MIA, 27.4%

Hydric Soils: Hydric, 27.4% of parcel

Non-Hydric, 72.6%

Flood Zone Designation: Outside Flood Area

CARA: Category 2 Recharge Areas

Forest Moratorium Area: No Mapping Indicators

Liquefaction Susceptibility: Very Low

NEHRP: C

Slope: 0 - 5 percent, 99.2% of parcel

5 - 10 percent, 0.8%

Landslide Hazards: No Mapping Indicators

Slope Stability: No Mapping Indicators

Habitat and Species Resources:

Habitat and Species Impacts: No Mapping Indicators

Cultural Resources:

Archeological Predictive: High, 12.4% of parcel

Moderate-High, 87.6%

Archeological Site Buffers: No Mapping Indicators

Historic Sites: No Mapping Indicators



2016 Aerial Photography

Account: 200355000, 200326000
 Owner: WELLS MARY ELLEN & DEMPSEY DIANNE M
 Address: 12502 NE 359TH ST
 C/S/Z: LACENTER, WA 98629

Printed on: March 21, 2019



Geographic Information System

0 200 400 Feet

 Subject Property(s)

32127	32126	32125
32134	32135	32136
22103	22102	22101

Information shown on this map was collected from several sources. Clark County accepts no responsibility for any inaccuracies that may be present.



2016 Aerial Photography with Elevation Contours

Printed on: March 21, 2019

Account: 200355000, 200326000
 Owner: WELLS MARY ELLEN & DEMPSEY DIANNE M
 Address: 12502 NE 359TH ST
 C/S/Z: LACENTER, WA 98629

32127	32126	32125
32134	32135	32130
22103	22102	22101

 Subject Property(s)
 2' Elevation Contours



Geographic Information System

0 100 200 Feet

Information shown on this map was collected from several sources. Clark County accepts no responsibility for any inaccuracies that may be present.

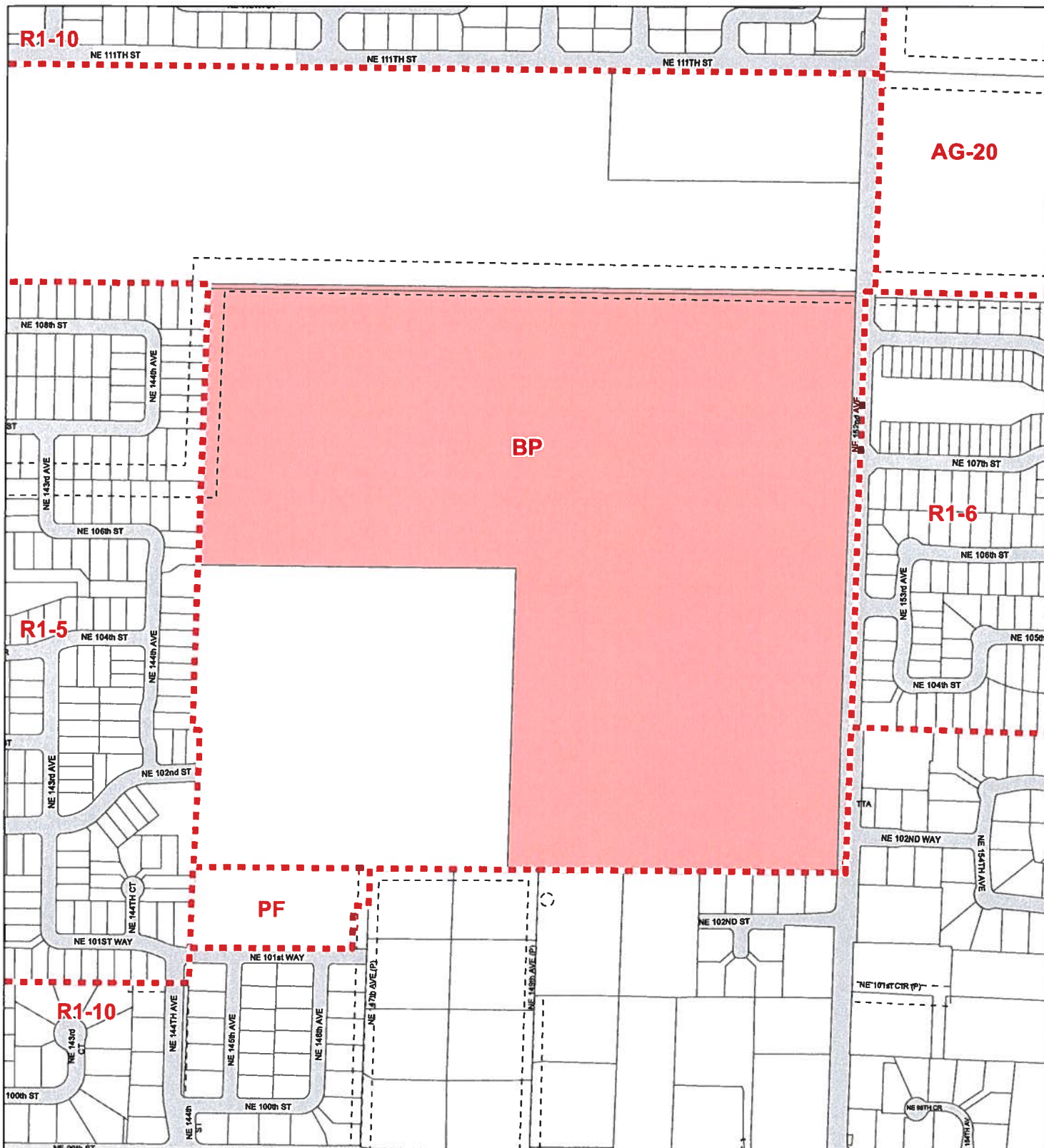

Clark County, Washington

Geographic Information System

0 200 400 Feet

Information shown on this map was collected from several sources. Clark County accepts no responsibility for any inaccuracies that may be present.

Zoning Designations

Account: 200355000, 200326000
 Owner: WELLS MARY ELLEN & DEMPSEY DIANNE M
 Address: 12502 NE 359TH ST
 C/S/Z: LACENTER, WA 98629

Printed on: March 21, 2019

- Subject Property(s)
- Public Road
- Transportation or Major Utility Easement
- Zoning Boundary
- Urban Holding - 10 (UH-10)
- Urban Holding - 20 (UH-20)
- Urban Holding - 40 (UH-40)
- Surface Mining Overlay District

32127	32128	32125
32134	32135	32136
22103	22102	22101

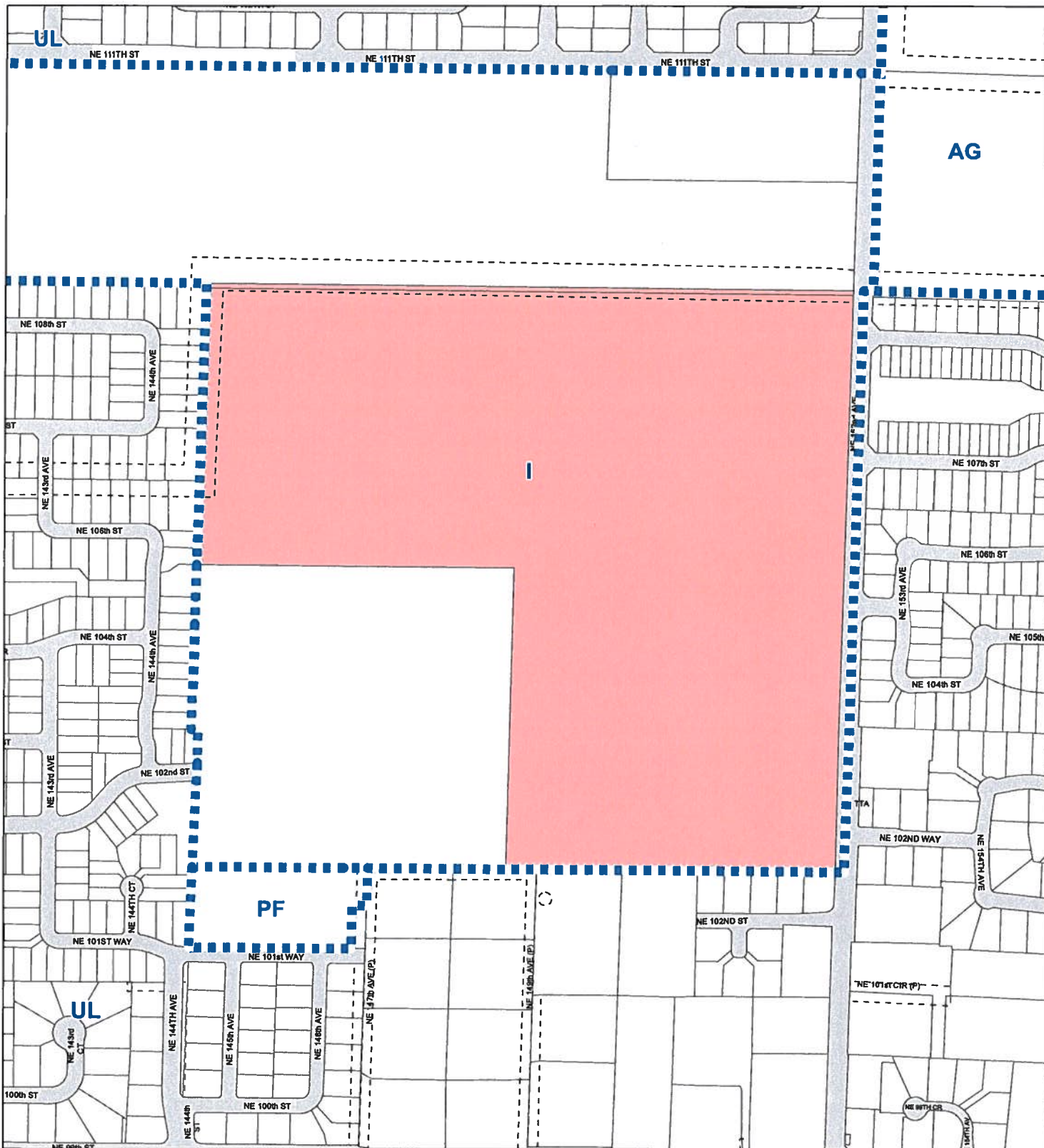

CLARK COUNTY, WASHINGTON

Geographic Information System

0 200 400 Feet

Information shown on this map was collected from several sources. Clark County accepts no responsibility for any inaccuracies that may be present.

Comprehensive Plan Designations

Account: 200355000, 200326000
 Owner: WELLS MARY ELLEN & DEMPSEY DIANNE M
 Address: 12502 NE 359TH ST
 C/S/Z: LACENTER, WA 98629

Printed on: March 21, 2019

- Subject Property(s)
- Public Road
- Transportation or Major Utility Easement
- Comprehensive Plan Boundary
- Urban Reserve
- Industrial Reserve
- Railroad Industrial Reserve
- Mining
- Rural Center Mixed Use
- Columbia River Gorge Scenic Area

32127	32128	32125
32134	32135	32136
22103	22102	22101

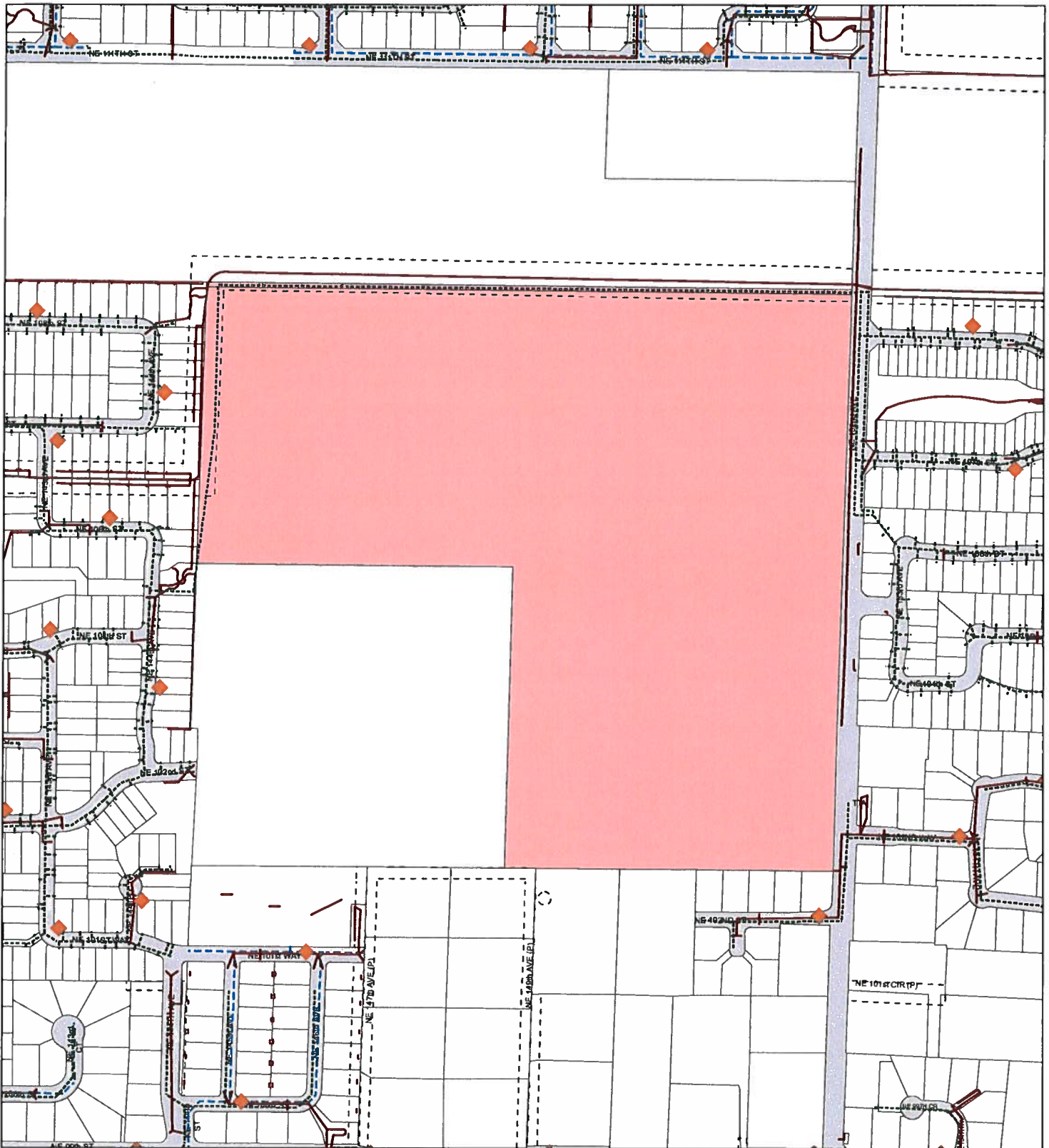

Geographic Information System

0 200 400 Feet

Information shown on this map was collected from several sources. Clark County accepts no responsibility for any inaccuracies that may be present.

Water, Sewer, and Storm Systems

Account: 200355000, 200326000
 Owner: WELLS MARY ELLEN & DEMPSEY DIANNE M
 Address: 12502 NE 359TH ST
 C/S/Z: LACENTER, WA 98629

- Subject Property(s)
- Public Road
- Transportation or Major Utility Easement
- Water Lines
- Sewer Lines
- Storm Water Lines
- 1-year Wellhead ZOC
- 5-year Wellhead ZOC
- 10-year Wellhead ZOC
- Hydrants

Printed on: March 21, 2019

32127	32128	32125
32134	32135	32136
22103	22102	22101

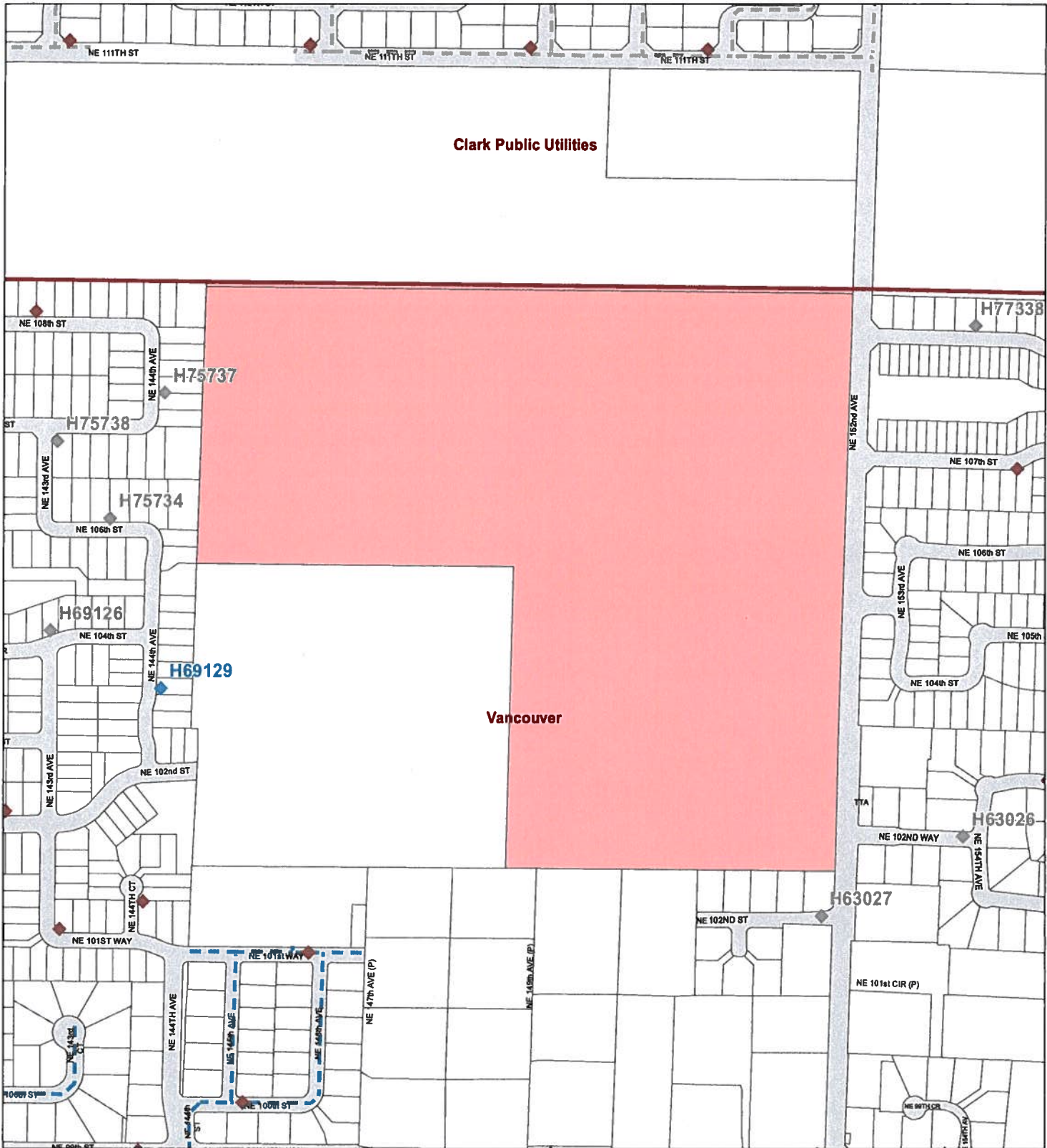

Clark Public Utilities

Vancouver

Water Systems

Account: 200355000, 200326000
 Owner: WELLS MARY ELLEN & DEMPSEY DIANNE M
 Address: 12502 NE 359TH ST
 C/S/Z: LACENTER, WA 98629

Printed on: March 21, 2019

Geographic Information System

0 200 400 Feet

- Subject Property(s)
- 10-20" Water Line
- > 20" Water Line
- Unknown Size Water Line
- < 10" Water Line
- > 1000 - 1749 GPM at 20 PSI
- > 1750 GPM at 20 PSI
- No Flow Data Hydrant
- 0 - 499 GPM at 20 PSI
- 500 - 999 GPM at 20 PSI
- Hydrant > 500' from parcel(s)

32127	32128	32125
32134	32135	32136
22103	22102	22101

Information shown on this map was collected from several sources. Clark County accepts no responsibility for any inaccuracies that may be present.

Hydrant Fire Flow Details

Account No.: 200355000, 200326000

Owner: WELLS MARY ELLEN & DEMPSEY DIANNE M

Address: 12502 NE 359TH ST

C/S/Z: LACENTER, WA 98629

Water District(s)	Hydrant Data Update	Project Site Provider
Vancouver	January 1, 2017	Service Provider
Clark Public Utilities	January 1, 2017	Adjacent District

HYDRANT INFORMATION:

Hydrant ID	Hydrant Owner	Main Diameter	Flow at 20 PSI	Test Date	Distance to site
H75737	Vancouver	0.0"	No Data	None	114 ft
H63027	Vancouver	0.0"	No Data	None	135 ft
H75734	Vancouver	0.0"	No Data	None	267 ft
H77338	Vancouver	0.0"	No Data	None	374 ft
H63026	Vancouver	0.0"	No Data	None	386 ft
H69129	Vancouver	0.0"	2061 GPM	November 17, 2016	391 ft
H75738	Vancouver	0.0"	No Data	None	434 ft
H69126	Vancouver	0.0"	No Data	None	487 ft

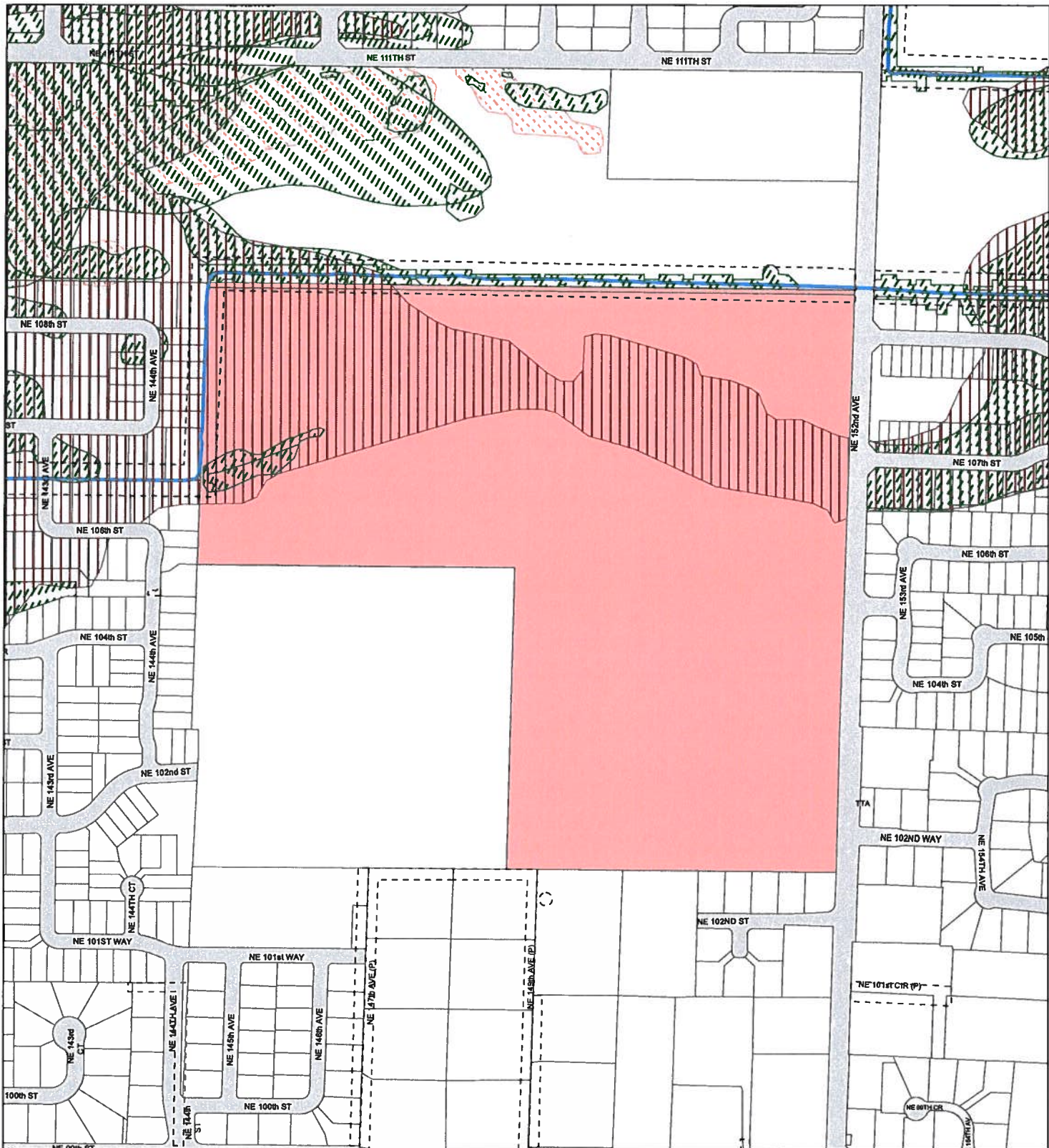

Environmental Constraints I

Account: 200355000, 200326000
 Owner: WELLS MARY ELLEN & DEMPSEY DIANNE M
 Address: 12502 NE 359TH ST
 C/S/Z: LACENTER, WA 98629

Printed on: March 21, 2019



Geographic Information System

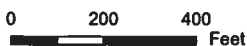

Information shown on this map was collected from several sources. Clark County accepts no responsibility for any inaccuracies that may be present.

- Subject Property(s)
- Public Road
- Transportation or Major Utility Easement
- Hydric Soils
- Wetland Inventory
- CARA Category 1
- Riparian Habitat or Species Area
- Non-Riparian Habitat or Species Area
- 100 year Floodplains
- Floodway
- Shorelines
- Stream

32127	32128	32125
32134	32135	32136
22103	22102	22101

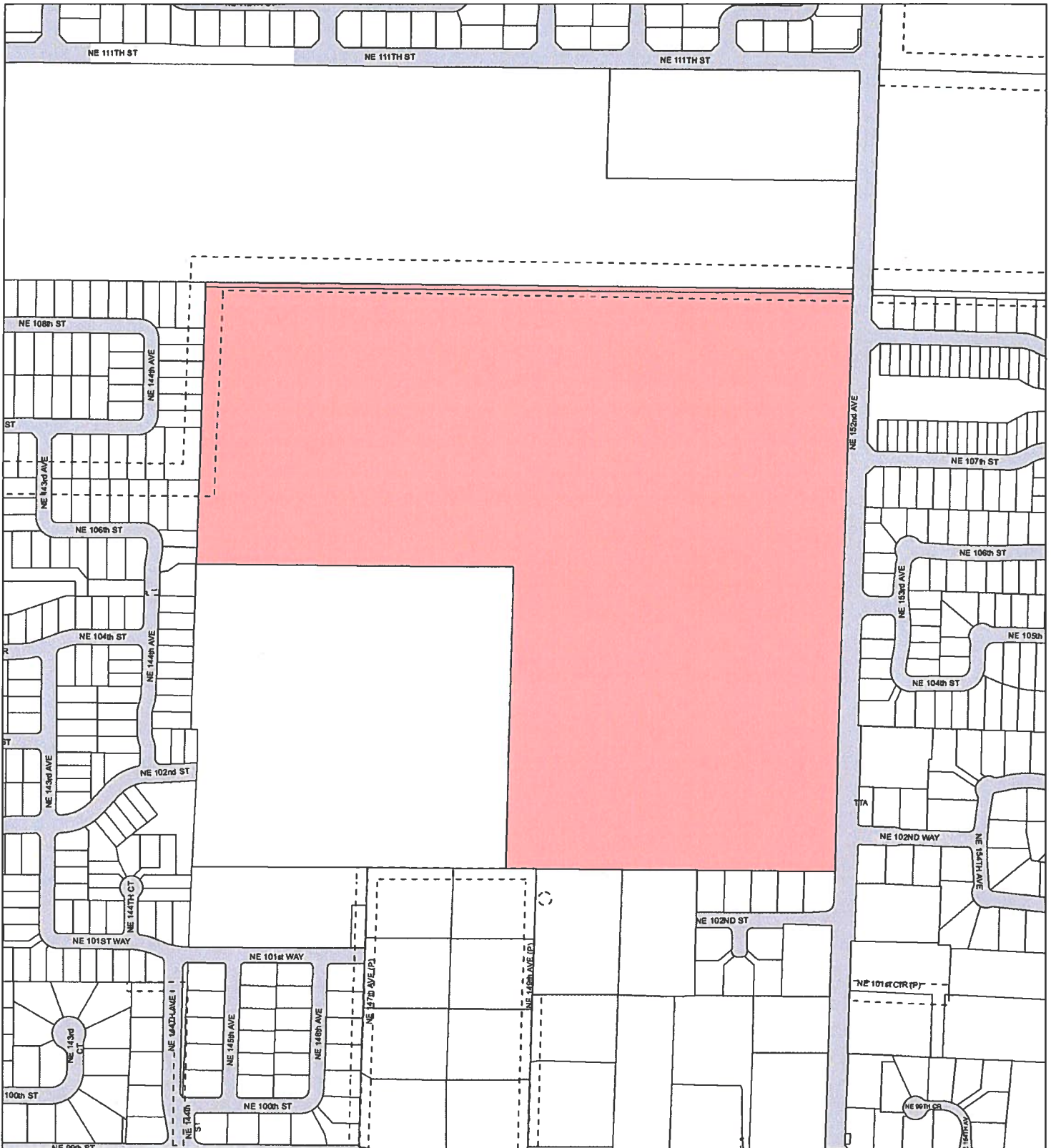

CLARK COUNTY, WASHINGTON

Geographic Information System

0 200 400 Feet

Information shown on this map was collected from several sources. Clark County accepts no responsibility for any inaccuracies that may be present.

Environmental Constraints II

Account: 200355000, 200326000
 Owner: WELLS MARY ELLEN & DEMPSEY DIANNE M
 Address: 12502 NE 359TH ST
 C/S/Z: LACENTER, WA 98629

- Subject Property(s)
- Public Road
- Transportation or Major Utility Easement
- Slopes > 15%
- Potentially Unstable Slope
- Historic or Active Landslide
- Severe Erosion Hazard Area
- Forest Moratorium Area
- CCHR Historic Site
- NRHP Historic Site
- INV Historic Site

Printed on: March 21, 2019

32127	32128	32125
32134	32135	32136
22103	22102	22101

21
200321

**NE 1/4
SECTION 35
T3N, R2E, W.M.**

NW 1/4
SECTION 35
T3N, R2E, W.M.

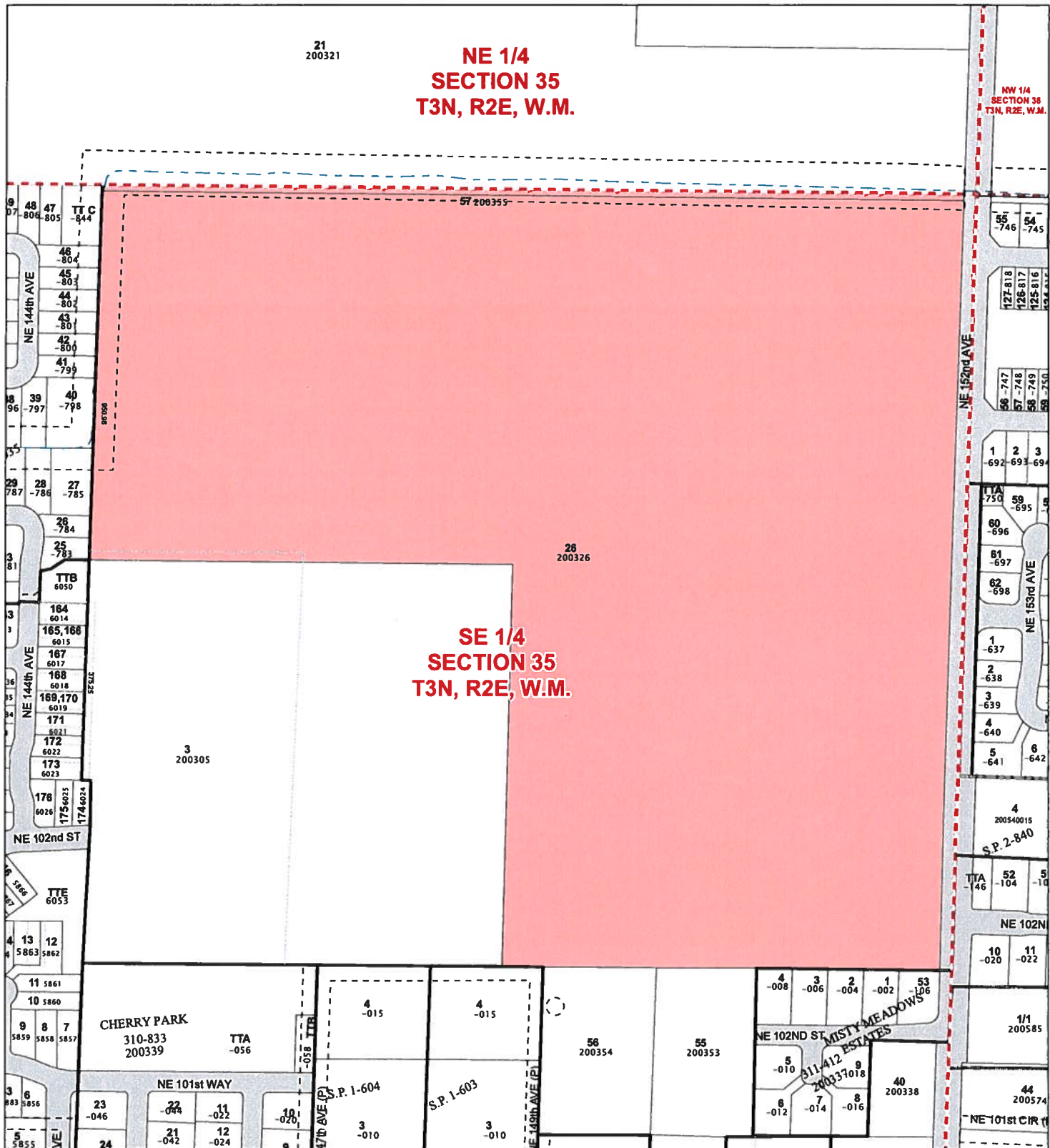

**SE 1/4
SECTION 35
T3N, R2E, W.M.**

Quarter Section Parcels

Account: 200355000, 200326000
Owner: WELLS MARY ELLEN & DEMPSEY DIANNE M
Address: 12502 NE 359TH ST
C/S/Z: LACENTER, WA 98629

Printed on: March 21, 2019

Geographic Information System

0 150 300 Feet

- Subdivision Lines
- Donation Land Claim
- Section Quarters
- City Boundaries
- Subject Property(s)
- Road Right of Way - Actual Road May not Exist
- Transportation or Major Utility Easement

32127	32128	32125
32134	32135	32138
22103	22102	22101

Information shown on this map was collected from several sources. Clark County accepts no responsibility for any inaccuracies that may be present.



CLARK COUNTY
WASHINGTON

COMMUNITY DEVELOPMENT
LAND USE REVIEW

SEPA Environmental Checklist

WAC 197-11-960

Rev 12.3.18

Working together. Securing your safety. Protecting your investment.

Purpose of checklist:

The State Environmental Policy Act (SEPA), Revised Code of Washington (RCW), Chapter 43.21C, requires all governmental agencies to consider the environmental impacts of a proposal before making decisions. An environmental impact statement (EIS) must be prepared for all proposals with significant adverse impacts on the quality of the environment. The purpose of this checklist is to provide information to help you and agencies identify impacts from your proposal and to help agencies decide whether or not an EIS is required.

Instructions for applicants:

This environmental checklist asks you to describe basic information about your proposal. Governmental agencies use this checklist to determine whether or not the environmental impacts of your proposal are significant. Please answer the questions briefly, giving the most precise information or best description known. In most cases, you should be able to answer the questions from your own observations or project plans without the need to hire experts. If you do not know the answer, or if a question does not apply to your proposal, write "do not know" or "does not apply."

Some questions pertain to governmental regulations such as zoning, shoreline, and landmark designations. If you have problems answering these questions, please contact the Clark County Permit Center for assistance.

The checklist questions apply to all parts of your proposal, even if you plan to do them over a period of time or on different parcels of land. Attach any additional information that will help describe your proposal or its environmental effects. You may be asked to explain your answers or provide additional information related to significant adverse impacts.

Use of checklist for non-project proposals:

Complete this checklist for non-project proposals (e.g., county plans and codes), even if the answer is "does not apply." In addition, complete the supplemental sheet for non-project actions (Part D).

For non-project actions, the references in the checklist to the words "project," "applicant," and "property or site" should be read as "proposal," "proposer," and "affected geographic area," respectively.

A. Background

1. Name of proposed project, if applicable: **Riverview Asset annual review application (2019)**
 2. Name of applicant: **Jordan Ramis PC, attorneys James Howsley and Armand Resto-Spotts, on behalf of Riverview Asset Management & Trust, trustees; Mary Ellen Wells, Dianne Dempsey**
 3. Address and phone number of applicant and contact person: **Jordan Ramis PC, 1499 SE Tech Center Pl, Suite 380, Vancouver, WA 98683**
 4. Date checklist prepared: **Submitted January 30, 2019;**
 5. Agency requesting checklist: **Clark County**
 6. Proposed timing or schedule (including phasing, if applicable): **Annual Review**
 7. Do you have any plans for future additions, expansion, or further activity related to or connected with this proposal? If yes, explain. **N/A at this time.**
 8. List any environmental information you know about that has been prepared, or will be prepared, directly related to this proposal. **Identified critical areas based on Clark County GIS for parcel numbers 200326000 and 200355000**
 9. Do you know whether applications are pending for governmental approvals of other proposals directly affecting the property covered by your proposal? If yes, explain. **Not known.**
 10. List any government approvals or permits that will be needed for your proposal, if known. **N/A at this time; N/A anticipated.**
 11. Give brief, complete description of your proposal, including the proposed uses and the size of the project and site. There are several questions later in this checklist that ask you to describe certain aspects of your proposal. You do not need to repeat those answers on this page. (Lead agencies may modify this form to include additional specific information on project description.)
Application seeks approval of a comprehensive plan amendment and zone change from Industrial (BP zoning) to Urban Low Density Residential (R1-10 zoning) and Commercial (Community Commercial (CC) zoning). The new designations would apply to both parcels.
-

12. Location of the proposal. Give sufficient information for a person to understand the precise location of your proposed project, including a street address, if any, and section, township, and range, if known. If a proposal would occur over a range of area, provide the range or boundaries of the site(s). Provide a legal description, site plan, vicinity map, and topographic map, if reasonably available. While you should submit any plans required by the agency, you are not required to duplicate maps or detailed plans submitted with any permit applications related to this checklist.

Address: 10512 NE 152nd Avenue, Vancouver, WA 98682; Section 35, Township 3N, R2E W.M.

B. Environmental Elements

1. Earth

a. General description of the site:

(circle one) Flat, rolling, hilly, steep slopes, mountainous, other

b. What is the steepest slope on the site (approximate percent slope)? **0-5%; essentially completely flat. One area on eastern portion of Parcel 200326000 shows 5-10 percent slope.**

c. What general types of soils are found on the site (for example, clay, sand, gravel, peat, muck)? If you know the classification of agricultural soils, specify them and note any agricultural land of long-term commercial significance and whether the proposal results in removing any of these soils.

Based on GIS mapping: Non-Hydric – DoB (~10%), HIA (~10%), LgB (~50-60%)

Hydric – MIA (~ 20%)

Clark County Property Information also indicates that LgB soils on site, but does not show on GIS mapping layers.

d. Are there surface indications or history of unstable soils in the immediate vicinity? If so, describe. **No.**

e. Describe the purpose, type, total area, and approximate quantities and total affected area of any filling, excavation, and grading proposed. Indicate source of fill. **Not known.**

f. Could erosion occur as a result of clearing, construction, or use? If so, generally describe.

Unlikely, but not known. Highly doubtful, as only ground work anticipated is basic grading of essentially flat surface area, incorporating best management practices and standard erosion control measures.

- g. About what percent of the site will be covered with impervious surfaces after project construction (for example, asphalt or buildings)?

Percentage not known. Residential and commercial layout not known at this time.

- h. Proposed measures to reduce or control erosion, or other impacts to the earth, if any:

Best management practices and standard erosion control measures.

2. Air

- a. What types of emissions to the air would result from the proposal during construction, operation, and maintenance when the project is completed? If any, generally describe and give approximate quantities if known. N/A

- b. Are there any off-site sources of emissions or odor that may affect your proposal? If so, generally describe. **Not known.**

- c. Proposed measures to reduce or control emissions or other impacts to air, if any:

Any conditions that may be imposed during later development process (not known at time).

3. Water

- a. Surface Water:

- 1) Is there any surface water body on or in the immediate vicinity of the site (including year-round and seasonal streams, saltwater, lakes, ponds, wetlands)? If yes, describe type and provide names. If appropriate, state what stream or river it flows into.

A wetland on western boundary of Parcel 200326000

- 2) Will the project require any work over, in, or adjacent to (within 200 feet) the described waters? If yes, please describe and attach available plans.

Yes. Any potential work would proceed in compliance with a wetland delineation and associated buffer/setback requirements.

3) Estimate the amount of fill and dredge material that would be placed in or removed from surface water or wetlands and indicate the area of the site that would be affected. Indicate the source of fill material. **N/A**

4) Will the proposal require surface water withdrawals or diversions? Give general description, purpose, and approximate quantities if known. **No.**

5) Does the proposal lie within a 100-year floodplain? If so, note location on the site plan. **No.**

6) Does the proposal involve any discharges of waste materials to surface waters? If so, describe the type of waste and anticipated volume of discharge. **No.**

b. Ground Water:

1) Will groundwater be withdrawn from a well for drinking water or other purposes? If so, give a general description of the well, proposed uses and approximate quantities withdrawn from the well. Will water be discharged to groundwater? Give general description, purpose, and approximate quantities if known.

City of Vancouver Water District.

2) Describe waste material that will be discharged into the ground from septic tanks or other sources, if any (for example: Domestic sewage; industrial, containing the following chemicals. . . ; agricultural; etc.). Describe the general size of the system, the number of such systems, the number of houses to be served (if applicable), or the number of animals or humans the system(s) are expected to serve. **Clark Regional Sewer District**

c. Water runoff (including stormwater):

1) Describe the source of runoff (including storm water) and method of collection and disposal, if any (include quantities, if known). Where will this water flow? Will this water flow into other waters? If so, describe.

Specific stormwater plans to be provided upon approval of application; exact development plans are not known at this time.

2) Could waste materials enter ground or surface waters? If so, generally describe. **Not known, but not anticipated with any future development plans. .**

3) Does the proposal alter or otherwise affect drainage patterns in the vicinity of the site? If so, describe. **No.**

d. Proposed measures to reduce or control surface, ground, and runoff water, and drainage pattern impacts, if any: **Any conditions of development approval at later date; best management practices.**

4. Plants

a. Check the types of vegetation found on the site: (Based on preliminary site evaluation; consistent with prior application)

deciduous tree: alder, maple, aspen, other **Some Oregon White Oak on site**

evergreen tree: fir, cedar, pine, other

shrubs

grass

pasture

crop or grain

Orchards, vineyards or other permanent crops.

wet soil plants: cattail, buttercup, bullrush, skunk cabbage, other **Unknown specific species.**

water plants: water lily, eelgrass, milfoil, other

other types of vegetation

b. What kind and amount of vegetation will be removed or altered? **Basic grading; not known at this time.**

c. List threatened and endangered species known to be on or near the site. **Not any known.**

d. Proposed landscaping, use of native plants, or other measures to preserve or enhance vegetation on the site, if any: **Will be determined at future development (as necessary). Not known at this time.**

e. List all noxious weeds and invasive species known to be on or near the site. **N/A (not known).**

5. Animals

a. List any birds and other animals which have been observed on or near the site or are known to be on or near the site.

Examples include:

birds: hawk, heron, eagle, songbirds, other:

mammals: deer, bear, elk, beaver, other:

fish: bass, salmon, trout, herring, shellfish, other _____

Not known

f. List any threatened and endangered species known to be on or near the site. **Not known.**

g. Is the site part of a migration route? If so, explain. **Not Known.** Pacific flyway migration route

d. Proposed measures to preserve or enhance wildlife, if any:

To be determined with future development proposal (as necessary). Not known at this time.

e. List any invasive animal species known to be on or near the site. **Not known.**

6. Energy and Natural Resources

a. What kinds of energy (electric, natural gas, oil, wood stove, solar) will be used to meet the completed project's energy needs? Describe whether it will be used for heating, manufacturing, etc. **To be determined with future development proposal. Not known at this time.**

b. Would your project affect the potential use of solar energy by adjacent properties? If so, generally describe. **No.**

c. What kinds of energy conservation features are included in the plans of this proposal? List other proposed measures to reduce or control energy impacts, if any: **To be determined with future development proposal.**

7. Environmental Health

a. Are there any environmental health hazards, including exposure to toxic chemicals, risk of fire and explosion, spill, or hazardous waste, that could occur as a result of this proposal? If so, describe.

1) Describe any known or possible contamination at the site from present or past uses.

Not known.

2) Describe existing hazardous chemicals/conditions that might affect project development and design. This includes underground hazardous liquid and gas transmission pipelines located within the project area and in the vicinity. **Not known.**

3) Describe any toxic or hazardous chemicals that might be stored, used, or produced during the project's development or construction, or at any time during the operating life of the project.

Not known.

4) Describe special emergency services that might be required.

Not known (but may be determined with future development proposal, as necessary)

5) Proposed measures to reduce or control environmental health hazards, if any: **Not known.**

b. Noise

1) What types of noise exist in the area which may affect your project (for example: traffic, equipment, operation, other)?

Basic traffic for any future development project (e.g., residential).

2) What types and levels of noise would be created by or associated with the project on a short-term or a long-term basis (for example: traffic, construction, operation, other)? Indicate what hours noise would come from the site.

Other than traditional noise associated with future development projects (e.g., residential construction), more specific noise impacts may be assessed/reviewed and mitigated at future development proposal review (as necessary).

3) Proposed measures to reduce or control noise impacts, if any:

To be determined at time of future development proposal (as necessary).

8. Land and Shoreline Use

a. What is the current use of the site and adjacent properties? Will the proposal affect current land uses on nearby or adjacent properties? If so, describe.

Current use of site is Business Park, but vacant land currently. No impact on nearby properties is anticipated with this amendment.

b. Has the project site been used as working farmlands or working forest lands? If so, describe. How much agricultural or forest land of long-term commercial significance will be converted to other uses as a result of the proposal, if any? If resource lands have not been designated, how many acres in farmland or forest land tax status will be converted to nonfarm or nonforest use? **Historically, used for agricultural**

purposes. Not known how much will be converted at this time.

50 + acres of property are in the current use program for Farm and Agricultural Land

- 1) Will the proposal affect or be affected by surrounding working farm or forest land normal business operations, such as oversize equipment access, the application of pesticides, tilling, and harvesting? If so, how: **Not known; no such impacts anticipated.**
- c. Describe any structures on the site. **Single-family residence.**
- d. Will any structures be demolished? If so, what? **Possibly; single family residence.**
- e. What is the current zoning classification of the site? **Business Park.**
- f. What is the current comprehensive plan designation of the site? **Industrial**
- g. If applicable, what is the current shoreline master program designation of the site? **N/A**
- h. Has any part of the site been classified as a critical area by the city or county? If so, specify.
Preliminary identification of a Category IV wetland.
- i. Approximately how many people would reside or work in the completed project?
Not known at this time.
- j. Approximately how many people would the completed project displace?
Reconstruction of single-family residence.
- k. Proposed measures to avoid or reduce displacement impacts, if any:
N/A (owner/applicant residence on site)
- L. Proposed measures to ensure the proposal is compatible with existing and projected land uses and plans, if any: **Land use review with staff through Annual Review application process.**
- m. Proposed measures to reduce or control impacts to agricultural and forest lands of long-term commercial significance, if any: **Properties are designated as Industrial under Comprehensive Plan, with Business Park zoning. This request for a change to Urban Low Density Residential with R1-10 zoning would not have a greater impact on agricultural lands than current designation and zoning. At time of future development, conditions and review may address any necessary mitigation measures.**

9. Housing

- a. Approximately how many units would be provided, if any? Indicate whether high, middle, or low-income housing. **Not known at this time.**
- b. Approximately how many units, if any, would be eliminated? Indicate whether high, middle, or low-income housing. **Possibly one single family residence.**

The proposed request is for 10k sq. ft. single family lots. The applicants' market analysis indicates homes on similar sized lots have had a median sales price of \$460K, that would be \$100k above the median sales price of homes in Clark County for 2018 per Washington State Center for Real Estate Research, Runstad Department of Real Estate. Washington State Housing Marke - Fourth Qtr -2018

c. Proposed measures to reduce or control housing impacts, if any:

Not known at this time. To be determined with future development proposal.

10. Aesthetics

a. What is the tallest height of any proposed structure(s), not including antennas; what is the principal exterior building material(s) proposed? **Not known at this time. Likely standard single family construction compliant materials.**

b. What views in the immediate vicinity would be altered or obstructed? **N/A**

b. Proposed measures to reduce or control aesthetic impacts, if any: **To be determined with future development proposal.**

11. Light and Glare

a. What type of light or glare will the proposal produce? What time of day would it mainly occur?
Standard single family residence.

c. Could light or glare from the finished project be a safety hazard or interfere with views? **Not anticipated.** What existing off-site sources of light or glare may affect your proposal? **None known.**

d. Proposed measures to reduce or control light and glare impacts, if any: **To be determined with future development proposal.**

12. Recreation

a. What designated and informal recreational opportunities are in the immediate vicinity?

Cherry Neighborhood Park; Kane Memorial Dog Park; Hockinson Meadows Community Park; Little League facilities; proposed Battled Ground School district facility

b. Would the proposed project displace any existing recreational uses? If so, describe. **No.**

c. Proposed measures to reduce or control impacts on recreation, including recreation opportunities to be provided by the project or applicant, if any: **To be determined with future development proposal.**

13. Historic and cultural preservation

a. Are there any buildings, structures, or sites, located on or near the site that are over 45 years old listed in or eligible for listing in national, state, or local preservation registers? If so, specifically describe. **None known.**

b. Are there any landmarks, features, or other evidence of Indian or historic use or occupation? This may include human burials or old cemeteries. Are there any material evidence, artifacts, or areas of cultural importance on

or near the site? Please list any professional studies conducted at the site to identify such resources. **None known.**

- c. Describe the methods used to assess the potential impacts to cultural and historic resources on or near the project site. Examples include consultation with tribes and the department of archeology and historic preservation, archaeological surveys, historic maps, GIS data, etc.

To be determined with future development proposal (archaeological assessment)

- d. Proposed measures to avoid, minimize, or compensate for loss, changes to, and disturbance to resources. Please include plans for the above and any permits that may be required. **To be determined with future development proposal (archaeological assessment)**

14. Transportation

- a. Identify public streets and highways serving the site or affected geographic area and describe proposed access to the existing street system. Show on site plans, if any.

Site is located west of NE 152nd Street, between NE 101st Way and NE 111th Street in Vancouver WA98682. Is the site or affected geographic area currently served by public transit? If so, generally describe. If not, what is the approximate distance to the nearest transit stop?

Within C-Tran benefit area. Transit stop #72 approximately .4 miles away from site.

- b. How many additional parking spaces would the completed project or non-project proposal have? How many would the project or proposal eliminate?

Not known at this time. Parking will be consistent with code requirements, to be determined with future development proposal.

- c. Will the proposal require any new or improvements to existing roads, streets, pedestrian, bicycle or state transportation facilities, not including driveways? If so, generally describe (indicate whether public or private).

Not known at this time. Future development proposal may include road improvements.

- d. Will the project or proposal use (or occur in the immediate vicinity of) water, rail, or air transportation? If so, generally describe. **No.**

- e. How many vehicular trips per day would be generated by the completed project or proposal? If known, indicate when peak volumes would occur and what percentage of the volume would be trucks (such as

commercial and nonpassenger vehicles). What data or transportation models were used to make these estimates? **Applicant's Traffic Impact Study will be provided to the County by February 2019 (see Narrative). Vehicular trip generation will compare current trip generation with proposed land use change. Daily, A.M., and P.M. peak out trips is expected to drop significantly. The decrease in trips generated by proposed new zone will significantly reduce traffic impacts compared to build out under existing zoning.** The traffic analysis indicates 378 less daily, 297 less am and 165 less pm peak hour trips under the proposed zoning.

- f. Will the proposal interfere with, affect or be affected by the movement of agricultural and forest products on roads or streets in the area? If so, generally describe. **Not anticipated.**
- g. Proposed measures to reduce or control transportation impacts, if any:
Decrease in trips generated by proposed comprehensive plan amendment change will significantly reduce traffic impacts for any future development build out. Additional measures to be determined at time of future development proposal.

15. Public Services

- a. Would the project result in an increased need for public services (for example: fire protection, police protection, public transit, health care, schools, other)? If so, generally describe.
Public services required for future development proposal, but not known at this time.
- b. Proposed measures to reduce or control direct impacts on public services, if any.
To be determined with future development proposal.

16. Utilities

- a. Circle utilities currently available at the site:
electricity, natural gas, water, refuse service, telephone, sanitary sewer, septic system, other
- c. Describe the utilities that are proposed for the project, the utility providing the service, and the general construction activities on the site or in the immediate vicinity which might be needed. **Utilities generally needed for single family residential development. But not precisely known at this time.**

Signature

The above answers are true and complete to the best of my knowledge. I understand that the lead agency is relying on them to make its decision.

Signature: 

Name of signee Armond Webb-Spotts

Position and Agency/Organization..... Applying Council / representative

Date Submitted: 1-30-19

C. Supplemental sheet for nonproject actions

(IT IS NOT NECESSARY to use this sheet for project actions)

Because these questions are very general, it may be helpful to read them in conjunction with the list of the elements of the environment.

When answering these questions, be aware of the extent the proposal, or the types of activities likely to result from the proposal, would affect the item at a greater intensity or at a faster rate than if the proposal were not implemented. Respond briefly and in general terms.

1. How would the proposal be likely to increase discharge to water; emissions to air; production, storage, or release of toxic or hazardous substances; or production of noise? **If requested comprehensive amendment is approved, applicant may apply for single family residential development proposal. Sewer system would accommodate residential discharges, stormwater management plans incorporated in design and approval. Standard noise associated with single family residences.**

Proposed measures to avoid or reduce such increases are: **To be implemented and determined with future development proposal.**

2. How would the proposal be likely to affect plants, animals, fish, or marine life? **Impacts to plants and animals that normally result from single family residential development would result either through business park development (as currently authorized), or through proposed designation into single family zone. Critical areas and vegetative analysis and mitigation provisions would be incorporated into project development applications, if plan designation is approved.**

Proposed measures to protect or conserve plants, animals, fish, or marine life are:

To be implemented and determined with future development proposal.

3. How would the proposal be likely to deplete energy or natural resources? **No depletion anticipated beyond normal use of single family residential development.**

4. Proposed measures to protect or conserve energy and natural resources are:

To be implemented and determined with future development proposal.

4. How would the proposal be likely to use or affect environmentally sensitive areas or areas designated (or eligible or under study) for governmental protection; such as parks, wilderness, wild and scenic rivers, threatened or endangered species habitat, historic or cultural sites, wetlands, floodplains, or prime farmlands?

Impacts to environmentally sensitive areas that normally result from site development would result if business park development or single family residential development.

Critical area analysis and evaluation for other protected status would be completed and mitigation measures would be incorporated into project development application.

Proposed measures to protect such resources or to avoid or reduce impacts are:

To be implemented and determined with future development proposal.

5. How would the proposal be likely to affect land and shoreline use, including whether it would allow or encourage land or shoreline uses incompatible with existing plans?

Not anticipated.

Proposed measures to avoid or reduce shoreline and land use impacts are: **To be implemented and determined with future development proposal.**

6. How would the proposal be likely to increase demands on transportation or public services and utilities? **Traffic Impact Study to be provided by Applicant by**

February 2019, which will compare transportation demands currently to

proposed use.

The traffic analysis indicates 378 less daily, 297 less am and 165 less pm peak hour trips under the proposed zoning.

Proposed measures to reduce or respond to such demand(s) are: **To be implemented and determined with future development proposal.**

7. Identify, if possible, whether the proposal may conflict with local, state, or federal laws or requirements for the protection of the environment. **Not anticipated.**

Riverview Trust Company – Annual Review / Zone Change Application Narrative

Summary

Riverview Trust Company (“Applicant”) requests a comprehensive plan amendment and zone change for its two parcels from Industrial (I) to Urban Low Density Residential (UL) and Commercial (C), with associated rezone from Business Park (BP) to single family residential (R1-10 zoning) and Community Commercial (CC). Parcels subject to this application include: 200326000 and 200355000 (“Subject Property”). The Applicant reserves the option to add adjacent parcel 200305000, which is owned by Battle Ground School District, into this request for comprehensive plan map amendment and zone change to facilitate the construction of a public school on parcel 200305000, and to facilitate compatible residential development on parcels 200326000 and 200355000. The Battle Ground School District authorized its parcel to be included in the Applicant's 2017 Annual Review application and submitted a letter in support at that time.

The Applicant's goal and objective is to achieve a comprehensive plan map and zoning designation that is compatible with the surrounding low density single family residential lands. The surrounding residential lands are developing successfully, unlike the business park use. There has been no development at this location since the Applicant's 2017 proposal. This application has a new commercial component as a response to Council's comments in their denial of the 2017-18 application.

Attachments

Exhibit A – Traffic Impact Study/Report

Exhibit B – Market Analysis Report

Exhibit C – Map of Vacant Industrial Land

Exhibit D – Excerpt from December 13, 2016 Pre-Application Conference Report

Project Location. The Subject Property, located generally at 10512 NE 152nd Ave. Vancouver, WA 98682, includes two (2) individual, adjacent parcels (200326000 and 200355000) totaling approximately 70 acres. *See* Exhibit B. Both parcels are owned by Riverview Asset Management & Trust, Dianne Dempsey and Mary Ellen Wells. The adjacent parcel 200305000 is owned by the Battle Ground School District.

Other adjacent development includes:

Parcel (ac)	Direction (From Subject Property)	Comprehensive Plan Designation	Zoning Designation
200321000 (34)	North	Industrial (I)	Business Park (BP)
Multiple residential lots	East	Urban Low (UL)	R1-6 and R1-10
200339056 (2.87) (County Park) and multiple residential lots	South	Public Facilities (PF) and Urban Low (UL)	Public Facilities (PF) and R1-10
Multiple residential lots	West	Urban Low (UL)	R1-5
200305000 (Battle Ground School District property)	Southwest	Industrial (I)	Business Park (BP)

Prior Permit and Review Activity. In January 2017, Applicant requested a comprehensive plan amendment and zoning change to amend the Subject Property from Industrial with Business Park zoning to Urban Low with R1-6 zoning. The Planning Commission denied Applicant’s request and found that the zoning currently in place for the Subject Property better implements the Comprehensive Plan policies than the proposed Urban Low R1-6 zoning. But the County Councilors discussed a split designation of residential and commercial. County Councilors suggested that a commercial component should be included as an alternative to a pure residential zone change. *See Commercial Component discussion below.* In the prior application review process, County Staff also noted that the concentration of residential development in the area should be broken up with some commercial piece along NE 152nd Avenue. *See Exhibit D (Excerpt).*

Pre-application Conference. The Applicant met with County staff in pre-application conference on December 4, 2018. The Applicant has incorporated staff’s suggestions and comments into this application.

Issues with Industrial Designation and Business Park Zoning. The current use, Business Park, has not successfully developed for over a decade. There is simply no market interest in this business park at this location. Surrounding properties are zoned for single family housing and continue developing for that use. There are other business parks in the general area that have been successful and have vacant space available for customers; however, the proposed business park use on the Subject Property is clearly not going to develop and is incompatible with all the surrounding land.

The BP zoning is incompatible with both the residential and school uses surrounding it. The BP zone requires a conditional use permit review for educational services, including elementary and secondary schools. CCC 40.230.085-1. The conditional use permitting process brings greater costs, longer time for review, and less certainty with the outcome. The BP zone also severely limits residential, institutional, office, and other nonindustrial uses to those necessary for the convenience and support of the noncommercial economic development and employment opportunities authorized within the BP zone. *See* CCC 40.340.085(A).

By contrast, in the R1-10 zone, Grade K-5 public and private schools uses, including preschools, are permitted outright. CCC 40.220.010-1. Residential development is also permitted outright. *Id.* This proposed use is the higher, better use of this land and is directly compatible with the surrounding area.

Beyond the permitting benefits from the change from BP to R1-10, the BP zoning does not fit the Subject Property. First, there is a lack of common transportation infrastructure and market attributes that are necessary to support a significant amount of businesses. BP districts typically have good access to major roads and are associated with larger commercial clusters. But in North Orchards, the BP district is completely isolated without convenient access to major roads or transit. There is no complimentary commercial zone nearby. This has resulted in a lack of market interest despite many years of exposure. The absence of lower intensity commercial to serve as a buffer creates the potential for land use conflicts between the BP district and the surrounding single family residential and school uses.

The amount of (continued) residential development in this area, compared to other business park locations, cannot go unremarked. The new Urban Oaks development is to the immediate east of the Subject Property, and there is a new plat to the immediate south. The Subject Property is nearly completely surrounded by residential zoning—from R1-5 to R1-10.

Wetlands and other sensitive areas further limit this site's potential for future industrial development. The adjacent property on the north side of the Subject Property—also zoned BP—has significant wetland area on-site, approximately 50% coverage. On the south and east/northwest sides of the Subject Property, there are Public Facilities zones, including a neighborhood park, a community regional park (used for little league activities), and a dog park.

As opposed to this location, there are other industrial lands and business parks nearby that are better suited for immediate and long-term industrial tenants and uses. There is substantial vacant industrial land near the I-205 corridor, especially to the north of the Subject

Property and county, as those lands would be better suited for railroad uses nearby, and east and west of SR 503, just north of NE 119th St. *See* Exhibit C (Vacant Industrial Land map). Several business parks southwest of the Subject Property, at Padden Pkwy and NE 117th St., have significant vacant land that is ready for lease (e.g., Padden Commerce Park and Olin Business Park). *Id.* These properties are just over two miles away from the Subject Property, and yet these too have plenty of vacant land to accommodate any anticipated industrial tenants or uses. The Subject Property's business park, however, is entirely vacant, has had no growth over the last decade and more, and brings with it other issues (as outlined above) as opposed to the currently existing BPs in the area.

Commercial Component. The Applicant has proposed the commercial strip along NE 152nd Ave in direct response to Councilor comments in 2017 on a better proposal for the Subject Property. In 2017, staff also indicated to the Applicant in the pre-application conference that a commercial component may be needed to break up all the residential development. *See* Exhibit E (Excerpt from December 13, 2016 Pre-Application Conference Report).

At the October 31, 2017 Board of County Councilors hearing, Councilors agreed with Planning Commission's recommendation for denial, finding that a purely residential use of the Subject Property is not preferred. However, Councilors did express their desire to see an alternative proposal in the future, since the business park zoning for this property is clearly not the best use of the site either.¹ *See* Recording of Board of County Councilors October 31, 2017 Meeting, at 1:18:00. Councilors suggested keeping some of the Subject Property commercial along with the residential piece and encouraged staff to inform the Applicant to continue that conversation and possible application in the future. *Id.* at 1:19:30, 1:21:10. Staff stated that depending on how this area has "developed" over the next year (2017-18), there may be better arguments for better use of the Subject Property. *Id.* at 1:21:20.

In response to these comments and direction, and to better promote job-producing land and potential alternatives, Applicant has proposed an alternative design for the Subject Property, adding in a commercial strip to break up the residential zoning. This strip of Community Commercial zoning would line NE 152nd Avenue and would be approximately 6-7 acres. The Community Commercial zoning will provide a small stretch of business opportunities for uses to serve the surrounding residential areas, which exist on all sides of the Subject Property. Limiting the commercial stretch to the frontage along NE 152nd Avenue would not impact the residential character of the surrounding areas, consisting almost exclusively of residential and school uses. Applicant, however, is open to discussing modifications to that design as may be desired by staff, Planning Commission, and Council direction.

The critical point remains that business park zoning is clearly not developing and is not the best use of this site. The Subject Property has remained vacant (absent single family home) for over a decade, and there has been no suggestion of industrial uses proposed for this site. The Subject Property is still not ideal for industrial uses (especially as compared to other areas with

¹ Board of County Councilors October 31, 2017 meeting: https://www.cvtv.org/vid_link/21261.

vacant business park and industrial lands) given its limited transportation routes and proximity to major thoroughfares. *See Exhibit C (Vacant Industrial Land Map)*. The Applicant's market analysis report will provide further detail on why the business park on the Subject Property is not appropriate and highly unlikely to ever develop in the future. *See Exhibit B*.

In January 2018, Applicant's council followed up with County Councilors on the Applicant's 2017 request to reaffirm the Council's original comments and intent going forward.²

R1-10 Zoning. In response to staff comments regarding R1-10 zoning, the Applicant proposes this zoning because it best fits with the character of the surrounding neighborhood. R1-10 zoning is already on both the immediately adjacent north and south sides of the Subject Property. Rural-5 and Rural-10 zoning are also within the area, which fit better with a less dense residential zone, as already existing (e.g., R1-10). The previously application proposed R1-6 zoning, per staff recommendation. However, R1-6 zoning is intended for higher single and duplex densities where there are a "full range of community services and facilities" present or to be developed. Currently, there is not a full range of community services and facilities in this area. Instead, Applicant is proposing to incorporate some commercial components with this comprehensive plan amendment and zone change. R1-10 zoning is most appropriate for a residential zone, given the surrounding zones and character of the neighborhood. This proposed zoning is also consistent with the City of Vancouver's suggestion for a denser single family designation at this site. *See City of Vancouver, December 3, 2018 letter to Clark County Community Planning*.

Traffic. The Applicant has engaged a traffic engineer for a Traffic Impact Study/Report, which is anticipated to be completed by February 2019. *See Exhibit A*. The Traffic Study will compare trip generation anticipated under current zoning designation (BP) and proposed R1-10 residential zoning and Community Commercial (CC) zoning. The proposed changed would result in significantly fewer daily and A.M. and P.M. peak hour net trips. The decrease in trips generated by the proposed amendment will significantly reduce traffic impacts compared to build out under existing zoning.

Market Analysis. The Applicant has engaged an economist for a Market Analysis Study/Report, which is anticipated to be completed by February 2019. *See Exhibit B*. The Applicant's analysis will provide further detail on why the commercial component is appropriate and consistent with comprehensive plan policies and elements, and how eliminating the business park use will not have a significant economic impact.

² Board of County Councilors January 9, 2018 meeting: https://www.cvtv.org/vid_link/24701 (at 26:30).

Criteria for Comprehensive Plan and Zone Change. Applicant meets the criteria for comprehensive plan amendment and zone change.

Pursuant to CCC 40.560.010, the applicant for a comprehensive plan amendment must demonstrate all the following criteria (Applicant response is below quoted provision):

- (1) Proponent shall demonstrate that the proposed amendment is consistent with the Growth Management Act and requirements, the countywide planning policies, the community framework plan, comprehensive plan, city comprehensive plans, applicable capital facilities plans and official population growth forecasts (CCC 40.560.010(G)(1));*

The Subject Property was first designated for urban development several years ago. The BP designation has failed to attract interest among employment users. The GMA allows replacement of this employment area with other areas better suited for the desired use.

Comprehensive Plan Policy 1.4.1 provides that interrelated uses should generally be encouraged to locate in close proximity of each other. The BP designation provides employment, but not the frequently used retail goods and services for nearby residents, as intended by this policy.

Policy 1.4.1 further provides that schools or other frequently used public facilities and the residential areas they serve should be allowed and encouraged to locate near one another. The west portion of the Subject Property is currently being constructed into a public elementary school to serve the surrounding residential area, consistent with this policy.

Similarly, Policy 1.4.1 provides that commercial, industrial, or other employers and the residential areas they serve should be allowed and encouraged to locate near to one another, as long as negative impacts from nonresidential uses on the residential areas are mitigated. Applicant's proposed strip of commercial zoning fronting NE 152nd Avenue on the Subject Property provides a small, but important piece of segment of land that would serve the residential areas nearby. Foremost, this commercial strip would retain some of the "job-producing" land that the BP zoning was intended to cultivate. Although the employment uses intended for the BP district have not developed because the district is isolated from primary roads and other supporting commercial uses that employers need for support, a smaller segment of commercial land—and one that is mixed within residential uses—would provide small business opportunities to the North Orchards area. Second, the proposed commercial strip would not have significant impacts on the surrounding residential uses, unlike the currently zoned BP district. The negative impacts from the BP uses, if it were developed, such as noise and traffic, would be unmitigated because there was no suitable buffer between that use and the residential area. However, with this proposed commercial strip, the possible impacts from traffic or other visual nuisances are mitigated given the size of the strip, its location on the road (i.e., buffer from residences across NE 152nd Avenue), and suitability for smaller businesses (rather than large big-box stores or industrial facilities).

The currently existing large BP district is an island surrounded by single family uses. By reducing that island to a strip fronting NE 152nd Avenue and converting it to a commercial use, the possible uses and impacts are significantly narrowed, and most importantly, blend in and support the surrounding residential uses. Policy 1.4.1 supports the placement of the commercial strip in this location, directly adjacent to the major road serving this area and of a small size as to not create unmitigated impacts to the surrounding residential uses.

Policy 2.1.5 requires that housing strategies and transportation area to be coordinated to assure reasonable access to public facilities and services. North Orchards continues to attract new families because the public facilities and services they require and desire are available. This will be enhanced with the development of the new school. In addition, the new school will be supplemented with new residences and a small commercial strip providing small business opportunities for the surrounding residences to support and use.

(2) The proponent shall demonstrate that the designation is in conformance with the appropriate locational criteria identified in the plan (CCC 40.560.010(G)(2));

The Comprehensive Plan notes that the location of housing stock is among the most significant policy issues. Here, North Orchards is a success story, and this site specific request builds on that success by placing a new school among the growing residential area. The school will be supported with additional housing needed to meet the continuing demand. The UL urban low density residential designation, with R-10 zoning, is proposed to ensure compatibility with the surrounding land use character. This is consistent with the location criteria in Chapter 1, Land Use Element.

Similarly, the proposed community commercial strip is consistent with the location criteria in the Comprehensive Plan. This strip would serve approximately 2-4 miles and is to be located on a major road, NE 152nd Avenue. This would be the only community commercial area in several miles.

(3) The map amendment or site is suitable for the proposed designation and there is a lack of appropriately designated alternative sites within the vicinity (CCC 40.560.010(G)(3));

North Orchards is running out of single family residential land. Thus, the cost of remaining residential land is increased, raising housing costs for everyone in the area. North Orchards has a successful track record for housing.

(4) The plan map amendment either (a) responds to a substantial change in conditions applicable to the area within which the subject property lies; (b) better implements applicable comprehensive plan policies than the current map designation; or (c) corrects an obvious mapping error (CCC 40.560.010(G)(4));

This request better implements plan policies than the current BP designation, because the BP district is misplaced within the surrounding single family North Orchards area, especially with the proposed school development. The school presents a land use conflict, particularly regarding traffic and access. The school will generate substantial traffic during the AM peak hour and in the late afternoon. This traffic cycle typically interferes with adjacent commercial uses, which have overlapping periods of peak use and is one reason why schools are typically located away from commercial uses. The proposed community commercial strip, however, is sufficiently small enough to not create significant impacts with traffic. *See Exhibit A (to be produced).* In fact, the community commercial strip is more appropriate for this area, given the small size of the proposed strip and the purely residential area it would be serving.

In addition, the nature of employment uses and their adverse impacts on a school serving young students creates a conflict with an adjacent business park. School function as community centers nearly seven days a week, whereas business park or industrial employment uses are primarily active only during business hours. An adjacent business park simply does not support the adjacent school use the same way that housing does. The truck traffic alone presents an obvious conflict with the children. By contrast, a community commercial use would fit the residential area and nearby school, as it would serve a small populace and would not interfere with school uses or children (e.g., large trucks, shipments, etc.).

(5) Where applicable, the proponent shall demonstrate that the full range of urban public facilities and services can be adequately provided in an efficient and timely manner to serve the proposed designation. Such services may include water, sewage, storm drainage, transportation, fire protection, and schools. Adequacy of services applies only to the specific change site. (CCC 40.560.010(G)(5)).

The full range of public facilities is available along NE 152nd Avenue and will be extended into this large site when development is approved. The County's arterial atlas has long anticipated the development of this approximately 70 acre site as a business park, which would have greater traffic impacts than the single family residential. According to the ITE Trip Generation Manual for Business Park, the PM peak hour trips should drop significantly for Single Family Detached Housing use. *See Exhibit A (to be produced).*

Additional notes: NE 152nd Avenue is classified as a two-lane collector (C-2), with 60' of ROW and 38' paved width. The cross-section includes two travel lanes, parking on both sides, and sidewalk on both sides. In 2017, staff reviewed the six-year Transportation Improvement Program and found no projects that would impact area immediately around the site of the proposed comprehensive plan amendment and zone change.

Pursuant to CCC 40.560.020(G), the Applicant for zone change request must demonstrate all the following criteria (*Applicant response is below quoted provision*):

(1) Requested zone change is consistent with the comprehensive plan map designation.

The Applicant is requesting a comprehensive plan map designation amendment that will result in consistency with the requested zone, as outlined above.

(2) The requested zone change is consistent with the plan policies and locational criteria and the purpose statement of the zoning district.

See analysis above.

(3) The zone change either (a) responds to a substantial change in conditions applicable to the area within which the subject property lies; (b) better implements comprehensive plan policies than the current map designation; or (c) corrects an obvious mapping error.

Applicant's requested zone change meets any of the above criteria, as outlined above in the analysis.

(4) There are adequate public facilities and services to serve the requested zone change.

See analysis above.

EXHIBIT A

TRAFFIC IMPACT STUDY

REPORT

Riverview Asset 2nd Annual Review Rezone Traffic Impact Study

March 14, 2019

H. Lee & Associates, PLLC

**RIVERVIEW ASSET 2nd ANNUAL REVIEW REZONE
TRAFFIC IMPACT STUDY**



Prepared for:

Armand Resto-Spotts
Jordan Ramis PC
1499 SE Tech Center Place #380
Vancouver, WA 98683

Prepared by:

H. Lee & Associates, PLLC
P.O. Box 1849
Vancouver, WA 98668
(360) 727-3119

March 14, 2019

TABLE OF CONTENTS

SECTION 1 - STUDY SUMMARY	1
Introduction	1
Summary of Findings.....	2
SECTION 2 - EXISTING CONDITIONS	5
Site Condition and Adjacent Land Use	5
Transportation Facilities	5
Existing Traffic Volumes.....	6
Existing Levels of Service	6
Accident History	11
Existing Public Transit Service.....	11
Non-Motorized Transportation.....	11
Planned Transportation Improvements.....	12
SECTION 3 - TRAFFIC IMPACT ANALYSIS.....	13
Analysis Methodology	13
Development Plans	13
Trip Generation	14
Trip Distribution and Assignment.....	15
2039 “Existing Zoning Build Out” Traffic Volumes and Levels of Service.....	18
2039 “Proposed Zoning Build Out” Traffic Volumes and Levels of Service	22
Signal Warrant Analysis	26
Conclusions.....	29
APPENDIX A	Traffic Counts
APPENDIX B	Existing Level of Service
APPENDIX C	Accident Data
APPENDIX D	RTC Model Volumes and TurnsW32 Worksheets
APPENDIX E	2039 “Existing Zoning Build Out” Levels of Service
APPENDIX F	2039 “Proposed Zoning Build Out” Levels of Service

LIST OF FIGURES

Figure 1. Site Vicinity Map.....	4
Figure 2. Existing Lane Configuration and Traffic Control.....	9
Figure 3. Existing Weekday A.M and P.M. Peak Hour Traffic Volumes	10
Figure 4a. Trip Distribution and Assignment - Existing Zoning (BP).....	16
Figure 4b. Trip Distribution and Assignment - Proposed Zoning (R1-10 & CC).....	17
Figure 5. 2039 “Existing Zoning Build Out” Traffic Volumes.....	21
Figure 6. 2039 “Proposed Zoning Build Out” Traffic Volumes	25

LIST OF TABLES

Table 1a. Existing Levels of Service.....	7
Table 1b. Existing V/C Ratios for Study Area Roadway Segments	8
Table 2. Summary of Traffic Accident History In Study Area	11
Table 3. Trip Generation NE 25 th Avenue Annual Review Rezone	15
Table 4a. 2039 “Existing Zoning Build Out” Levels of Service	19
Table 4b. 2039 “Existing Zoning Build Out” V/C Ratios for Study Area Roadway Segments.....	20
Table 5a. 2039 “Proposed Zoning Build Out” Levels of Service.....	23
Table 5b. 2039 “Proposed Zoning Build Out” V/C Ratios for Study Area Roadway Segments	24
Table 6. 2039 P.M. Peak Hour Signal Warrant Summary at NE 152 nd Avenue/NE 99 th Street	28

SECTION I STUDY SUMMARY

INTRODUCTION

This traffic impact analysis has been prepared to assess transportation impacts related to the proposed rezone of lots 200326-000 and 200355-000 in Clark County, Washington. The project site is located at 10512 NE 152nd Avenue. The existing parcels are approximately 60.13 acres and are currently zoned BP. The rezone proposal is to change the existing zoning from BP to a combination of R1-10 and CC. Figure 1 shows the project vicinity.

Project Description

The proposed project site is 2,619,263 square feet which is 60.13 acres. The build out of the existing BP zoning was based on a floor area ratio (FAR) of 0.25. Applying this FAR to the size of the project site yields a build out of 654,815 square feet of business park space. For trip generation purposes the build out of the existing zoning was assumed to be general office use.

The proposed CC zoning portion of the project site is 304,920 square feet which is 7.0 acres. The build out of the proposed CC zoning portion of the project was based on a floor area ratio (FAR) of 0.25. Applying this FAR to the size of the proposed commercial portion of the project site yields a build out of 76,230 square feet of commercial space.

The proposed R1-10 zoning portion of the project site is 53.13 acres. The build out of the proposed R1-10 zoning portion of the project site was based on Clark County Code (CCC) Table 40.220.010-4. Based on CCC Table 40.220.010-4, the maximum density for the R1-10 zoning is 3.5 dwelling units per acre. Applying the maximum density for the R1-10 zoning to the size of the proposed R1-10 portion of the project site yields a build out of 185 single-family detached dwelling units.

Scope of Traffic Impact Study

The scope of the traffic impact study was developed from Clark County's Pre-Application Conference Summary and adjusted based on known Clark County traffic study requirements. From this information, the following intersections were determined to require analysis:

- NE 152nd Avenue/NE 119th Street
- NE 117th Avenue (SR 503)/NE 99th Street
- NE 152nd Avenue/NE Padden Parkway
- NE 152nd Avenue/NE 99th Street

The remainder of this report presents the following analysis:

- Existing P.M. peak hour traffic conditions in the project study area.
- Trip generation estimates for the build out of the existing zoning and the proposed zoning.
- Trip distribution and assignment of trips generated by the build out of the existing zoning and the proposed zoning.
- The 2039 condition traffic volumes were derived from RTC’s 2035 regional transportation forecast model. The RTC model link volumes were post-processed to turning movement volumes based on the NCHRP 255 methodology and the TurnsW32 software. These 2035 post-processed turning movement traffic volumes were adjusted with a two (2) percent compounded annual growth factor to adjust the volumes to the 2039 analysis year. Since the RTC model included the build out of the project site assuming the existing zoning, these volumes represent the 2039 “Existing Zoning Build Out” condition traffic volumes.
- The 2039 “Proposed Zoning Build Out” condition traffic volumes were derived by subtracting the existing zoning trips from the 2039 “Existing Zoning Build Out” traffic volumes and then adding the proposed zoning trips.
- The 2039 “Existing Zoning Build Out” and 2039 “Proposed Zoning Build Out” conditions were analyzed and compared to each other to determine the traffic impacts of the rezone proposal.

SUMMARY OF FINDINGS

The following are the findings and recommendations from the traffic analysis:

Findings

- The “Existing Zoning Build Out” is expected to generate 4,292 daily, 511 A.M. peak hour (341 in, 170 out), and 508 P.M. peak hour (85 in, 423 out) net new trips.

The “Proposed Zoning Build Out” is expected to generate 3,914 daily, 214 A.M. peak hour (87 in, 127 out), and 343 P.M. peak hour (182 in, 161 out) net new trips.

The “Proposed Zoning Build Out” is expected to generate 378 less daily, 297 less A.M. peak hour (-254 in, -43 out), and 165 less P.M. peak hour (+97 in, -262 out) net new trips. The increase in trips generated by the build out of the proposed rezone is negligible compared to the existing zoning impacts.

- The study area intersections are projected to operate at acceptable levels of service in the 2039 “Existing Zoning Build Out” and 2039 “Proposed Zoning Build Out” conditions.

- All of the study area roadway segment v/c ratios are all within the acceptable standard in the 2039 “Existing Zoning Build Out” and 2039 “Proposed Zoning Build Out” conditions.
- While the cursory signal warrant analysis indicates that a traffic signal may need to be installed in any 2039 condition, for this rezone analysis the main issue is the impact of the rezone proposed on current transportation facilities and whether adequate facilities exist. First, the rezone build out traffic impacts are projected to be less than the existing zoning build out and could lessen additional infrastructure needs. Second, should a signal be required in the future at the NE 152nd Avenue/NE 99th Street intersection, that potential mitigation is well within the future development’s ability to mitigate as part of a condition of approval.

Recommendations

- Based on the traffic impact analysis documented in this report, no physical, off-site mitigation would be needed.
- Based on the traffic impact analysis documented in this report, the rezoning of the Riverview Asset property will not result in any significant degradation in traffic conditions in the project vicinity.

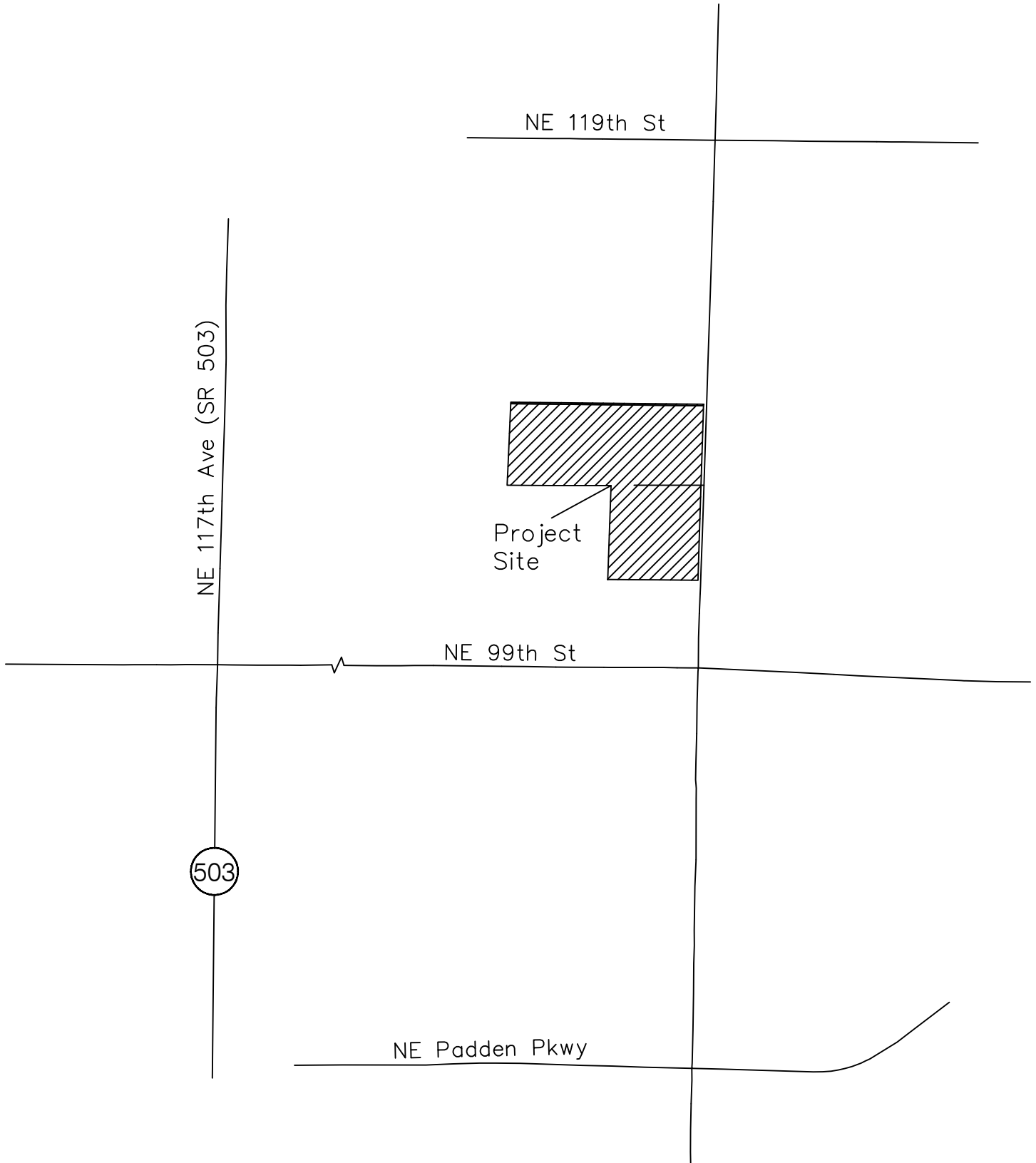

FIGURE 1
Site Vicinity Map

SECTION II EXISTING CONDITIONS

SITE CONDITION AND ADJACENT LAND USE

There is one existing single-family detached home on-site that will be demolished upon construction of the development. Residential uses surround the project site.

TRANSPORTATION FACILITIES

The following provides a description of the existing street system in the study area including a description of street classifications and characteristics.

NE 99th Street: NE 99th Street is a three-lane minor arterial (M-2cb) with bike lanes and sidewalks along both sides of the roadway east of NE 117th Avenue (SR 503). West of NE 117th Avenue, NE 99th Street is a two-lane minor arterial (M-2cb) with intermittent sidewalks along both sides of the roadway. The posted speed limit is 35 mph east of NE 117th Avenue (SR 503) and 30 mph to the west.

NE 117th Avenue (SR 503): NE 117th Avenue (SR 503) is a four-to-five lane state highway with additional turn lanes at major intersections. It is classified as a principal arterial. Sidewalks exist along both sides of the roadway. The posted speed limit is 50 mph north of NE 131st Street and 40 mph to the south.

NE 152nd Avenue: NE 152nd Avenue is classified as urban collector (C-2). The roadway is comprised of two travel lanes with additional turn lanes at major intersections. Intermittent bike lanes and sidewalks exist on both sides of the roadway. North of NE 119th Street the posted speed limit is 40 mph and south of NE 119th Street the posted speed limit is 35 mph.

NE 119th Street: NE 119th Street is a two-lane minor arterial (M-2cb) roadway east of NE 117th Avenue (SR 503). West of NE 117th Avenue, NE 119th Street is a two-lane minor arterial (M-4cb). At the NE 119th Street/NE 117th Avenue intersection, NE 119th Street widens significantly to accommodate additional through lanes and turn lanes. Intermittent sidewalks exist along both sides of the roadway. East of NE 132nd Avenue the posted speed limit is 50 mph and west of NE 132nd Avenue the posted speed limit is 45 mph.

NE Padden Parkway: NE Padden Parkway is a state route (SR 500) in the study area between NE 117th Avenue (SR 503) and NE 162nd Avenue. The roadway is four-to-five lanes with intermittent medians. Additional turn lanes exist at major intersections. A detached/attached sidewalk exists on the north side of the roadway. A separated non-motorized path exists on the south side of the roadway. The posted speed limit is 50 mph.

As part of this study, levels of service analyses were performed for the following intersections:

- NE 152nd Avenue/NE 119th Street
- NE 117th Avenue (SR 503)/NE 99th Street
- NE 152nd Avenue/NE Padden Parkway
- NE 152nd Avenue/NE 99th Street

Figure 2 shows the lane configuration and traffic control at the study area intersections.

EXISTING TRAFFIC VOLUMES

P.M. peak hour traffic counts were obtained at the study area intersections by H. Lee & Associates, PLLC (HLA) in September and October 2018. Per the 2010 HCM¹, peak 15-minute traffic volumes were multiplied by four (4) to arrive at the peak hour traffic volumes. With this methodology of developing peak hour traffic volumes, the peak hour factor (PHF) is set to 1.00 because the peaking has already occurred by multiplying the peak 15-minute traffic volume by four (4). The existing condition traffic volumes are presented in Figure 3. The existing traffic counts can be referenced in Appendix A.

EXISTING LEVELS OF SERVICE

Based on the traffic volumes in Figure 3 and the existing lane configurations presented in Figure 2, peak hour traffic operations were analyzed at the study area intersections using the methodologies outlined in the 2010 Highway Capacity Manual (HCM). According to the HCM, there are six levels of service (LOS) by which the operational performance of an intersection may be described. These levels of service range between LOS "A" which indicates a relatively free-flowing condition and LOS "F" which indicates operational breakdown. For signalized intersections of regional significance within Clark County, individual movements at each signalized intersection shall not exceed an average of two (2) cycle lengths or two hundred forty (240) seconds of delay (whichever is less) per CCC 40.350.020.G.1.b.

For unsignalized intersections of regional significance within Clark County, LOS "E" is the minimum acceptable standard in Clark County, as long as signal warrants are not met per CCC 40.350.020.G.1.c. For unsignalized intersections, the level of service and delay reported is by approach or conflicting movement. If signal warrants are met, then the standard is LOS D or better. The signalization of an unsignalized intersection shall be at the sole discretion of the Clark County Public Works Director and shall not obligate Clark County to meet this level of service standard. However, proposed developments shall not be required to mitigate their impacts in order to obtain a concurrency approval unless:

¹ 2010 Highway Capacity Manual (HCM), Volume 3, Transportation Research Board, 2010, page 18-2 and 18-3.

- 1) The proposed development adds at least five (5) peak period trips to a failing approach; and
- 2) The worst movement on a failing approach is worsened by the proposed development. In determining whether the movement is worsened, the Public Works director shall consider trip volume, delay, and any other relevant factors.

The existing P.M. peak hour levels of service at the study area intersections are summarized in Table 1a. As shown in Table 1a, all of the signalized intersection individual movements are projected to operate within Clark County’s concurrency standard of an average delay of less than two (2) cycle lengths or two hundred forty (240) seconds (whichever is less). The unsignalized study area intersection is currently operating at acceptable levels of service of LOS C or better in the existing condition. Appendix B contains the levels of service worksheets for the existing condition.

Part of the traffic study requirements is to calculate v/c ratios of the roadway segments identified in the pre-application conference report per CCC 40.350.020.G.1.a and Table 40.350.020-1. Table 1b summarizes the v/c ratios for the study area roadway segments for the existing condition. The peak hour traffic volumes were taken from Figure 3 and the capacities were based on the roadway functional classifications and CCC Table 40.350.020-1. Per CCC 40.350.020.G.1.a, the study area roadway segment v/c ratio standard is 0.90. As shown in Table 1b, all of the study area roadway segment v/c ratios are all within the acceptable standard in the existing condition.

Table 1a. Existing Levels of Service

Signalized Intersection	P.M. Peak Hour	
	LOS	Average Delay (sec)
NE 152 nd Avenue/NE 119 th Street		
Eastbound Approach	A	9.2
Westbound Approach	A	8.3
Northbound Approach	A	6.7
Southbound Approach	A	5.7
Overall	A	7.3
NE 117 th Avenue (SR 503)/NE 99 th Street		
Eastbound Left	C	33.0
Eastbound Through	D	41.7
Eastbound Right	D	35.1
Westbound Left	C	33.2
Westbound Through	D	38.3
Westbound Right	D	35.6
Northbound Left	B	11.2
Northbound Through	B	19.5
Northbound Right	A	7.0
Southbound Left	B	18.2
Southbound Through	B	14.3
Southbound Right	A	6.9
Overall	C	21.2

Table 1a. Existing Levels of Service Continued

Signalized Intersection	P.M. Peak Hour	
	LOS	Average Delay (sec)
NE 152 nd Avenue/NE Padden Parkway		
Eastbound Left	D	40.9
Eastbound Through	D	41.5
Eastbound Right	C	21.1
Westbound Left	D	52.9
Westbound Through	C	23.7
Westbound Right	B	12.0
Northbound Left	C	26.6
Northbound Through/Right	D	42.1
Southbound Left	C	32.4
Southbound Through	D	39.0
Southbound Right	C	26.1
Overall	C	33.7
All-Way Stop Intersection		
NE 152 nd Avenue/NE 99 th Street	C	23.8

Table 1b. Existing V/C Ratios for Study Area Roadway Segment

Roadway Segment	P.M. Peak Hour Volume	Capacity	P.M. V/C Ratio
NE 119 th Street			
West of NE 152 nd Avenue – EB	264	900	0.29
West of NE 152 nd Avenue – WB	280	900	0.31
East of NE 152 nd Avenue – EB	184	900	0.20
East of NE 152 nd Avenue – WB	156	900	0.17
NE 152 nd Avenue			
North of NE 119 th Street – NB	312	800	0.39
North of NE 119 th Street – SB	236	800	0.30
NE 119 th Street to NE 99 th Street – NB ¹	442	800	0.55
NE 119 th Street to NE 99 th Street – SB ¹	326	800	0.41
NE 99 th Street to NE Padden Parkway – NB ¹	480	800	0.60
NE 99 th Street to NE Padden Parkway – SB ¹	450	800	0.56
NE 99 th Street			
SR 503 to NE 152 nd Avenue – EB ¹	334	900	0.37
SR 503 to NE 152 nd Avenue – WB ¹	382	900	0.42
East of NE 152 nd Avenue – EB	164	900	0.18
East of NE 152 nd Avenue – WB	124	900	0.14

¹The traffic volume is the average of the upstream and downstream traffic volumes of the roadway segment.

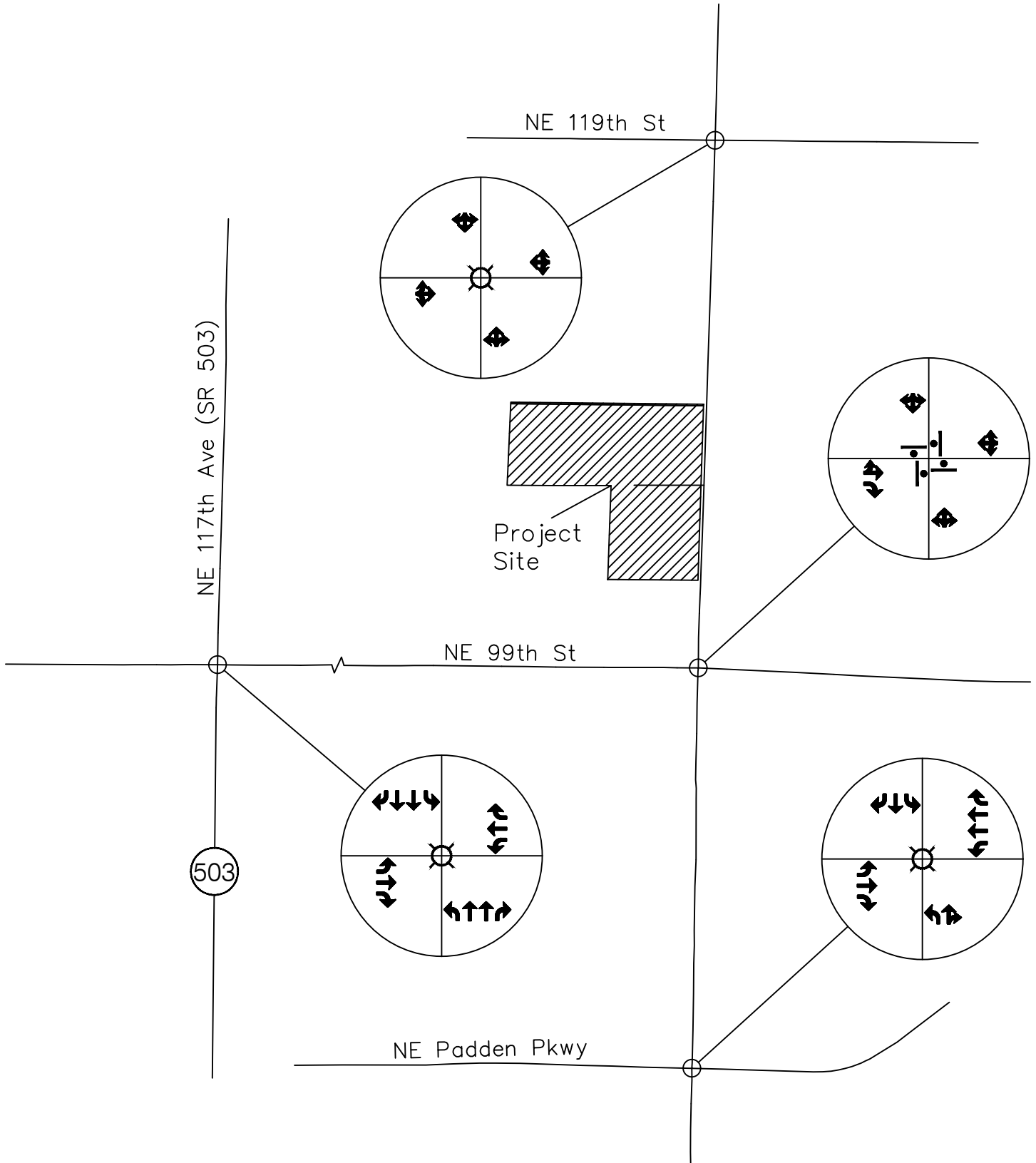

LEGEND

-  Lane Usage
-  Traffic Signal
-  Stop Sign

FIGURE 2
Existing Lane Configuration and Traffic Control

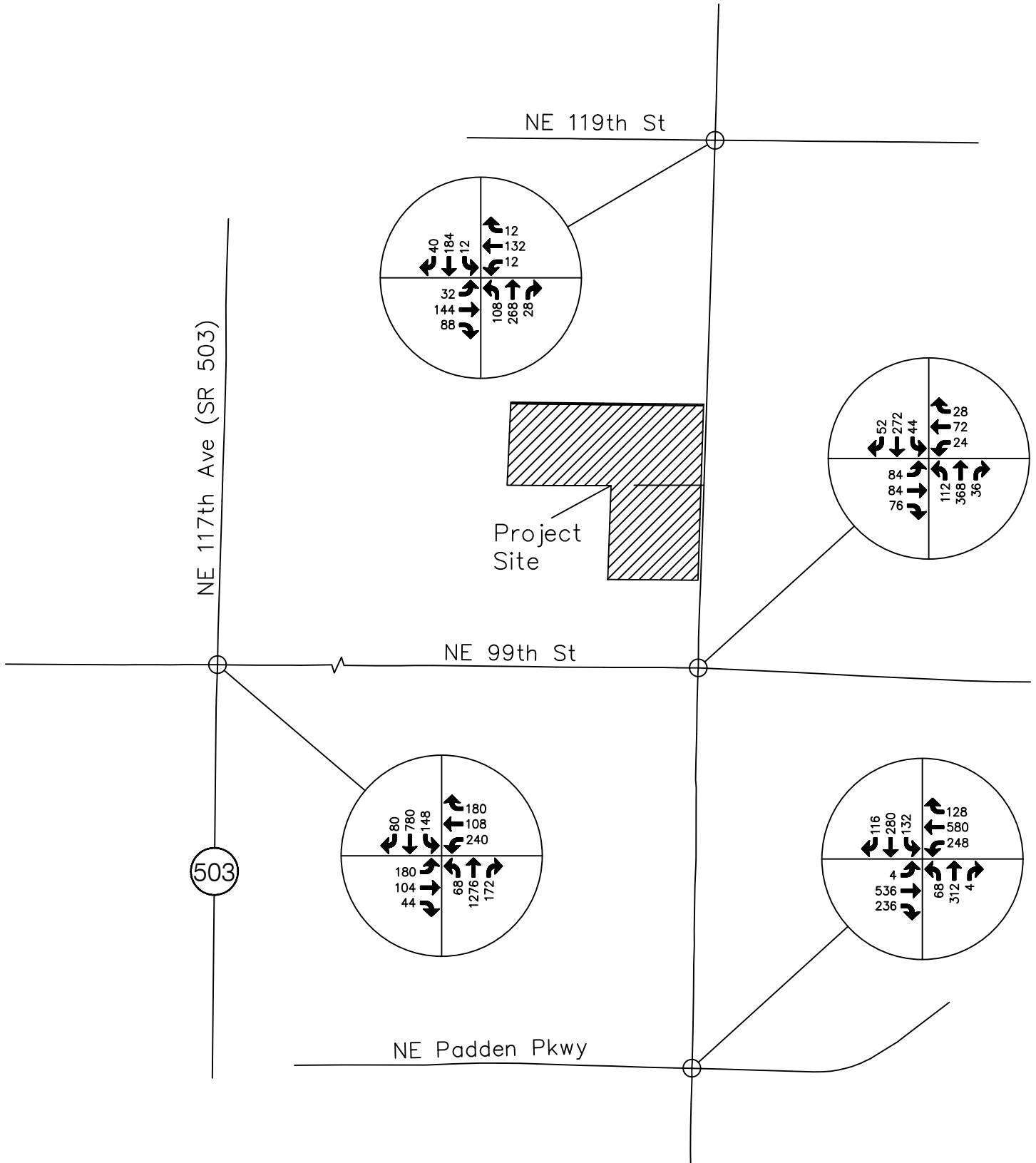

LEGEND

200 P.M. Peak Hour
Traffic Volume

FIGURE 3
Existing P.M.
Peak Hour Traffic Volumes

ACCIDENT HISTORY

Accident data was obtained from the Washington State Department of Transportation (WSDOT) for the five year and one month period between January 1, 2014 and January 31, 2019. The data includes total crashes and crashes by severity (i.e., fatality, injury, or property damage only). The accident analysis is summarized in Table 2 for the study area intersections. Appendix C contains the accident data.

Generally, an accident rate of less than 1.00 accidents per million entering vehicles is considered acceptable and no further analysis is necessary. As shown in Table 2, all of the accident rates at the study area intersections are below 1.00 accidents per million entering vehicles, so no further analysis was conducted.

It should be noted that there were two fatal accidents at the NE 152nd Avenue/NE 119th Street intersection. The first accident was on November 22, 2017 and was due to vehicle 1 not granting the proper right-of-way to vehicle 2. The second accident was on September 13, 2017 and was due to vehicle 1 running the red light. As previously stated, these fatal accidents were due to driver error and were not in any relation to the functionality of the intersection.

Table 2. Summary of Traffic Accident History at Intersections in the Study Area

Intersection	Average Annual Accidents				acc/mev ²
	PDO ¹	Injury	Fatal	Total	
NE 152 nd Avenue/NE 119 th Street	1.6	2.0	0.4	4.0	0.83
NE 117 th Avenue (SR 503)/NE 99 th Street	4.7	3.0	0.0	7.7	0.50
NE 152 nd Avenue/NE Padden Parkway	2.0	3.1	0.0	5.1	0.42
NE 152 nd Avenue/NE 99 th Street	1.6	0.2	0.0	1.8	0.32

¹ PDO = property damage only

² acc/mev = accidents per million entering vehicles

EXISTING PUBLIC TRANSIT SERVICE

C-Tran provides public transit service in Clark County. Currently there are no routes that provide service adjacent to the project site. The closest route to the project site is Route #72 – Orchards, which provides service approximately 0.16 miles south of the project site at the NE 152nd Avenue/NE 99th Street intersection.

NON-MOTORIZED TRANSPORTATION

Sidewalks exist along both sides of NE 152nd Avenue in newly developed areas.

PLANNED TRANSPORTATION IMPROVEMENTS

A review of the Clark County's Six-Year Transportation Improvement Program (TIP), 2018-2023, revealed that there are no reasonably funded projects in the study area.

The following project is partially funded:

NE 152nd Avenue – Padden Parkway to NE 99th Street

This project includes improving the existing two-lane collector (C-2) roadway to a two-lane collector (C-2cb) roadway with sidewalks and bike lanes along both sides of the roadway. The scoping for this project is anticipated for 2019. The total estimated project cost is \$8,100,000.

SECTION III TRAFFIC IMPACT ANALYSIS

ANALYSIS METHODOLOGY

The P.M. peak hour traffic impacts generated by the proposed Riverview Asset 2nd Annual Review Rezone were analyzed as follows.

- Trip generation estimates for the build out of the existing and proposed zonings were estimated using the rates in "Trip Generation, 10th Edition," (Institute of Transportation Engineers, 2017).
- Trip distribution and assignment of trips generated by the build out of the existing and proposed zonings.
- The 2039 condition traffic volumes were derived from RTC's 2035 regional transportation forecast model. The RTC model link volumes were post-processed to turning movement volumes based on the NCHRP 255 methodology and the TurnsW32 software. These 2035 post-processed turning movement traffic volumes were adjusted with a two (2) percent compounded annual growth factor to adjust the volumes to the 2039 analysis year. Since the RTC model included the build out of the project site assuming the existing zoning, these volumes represent the 2039 "Existing Zoning Build Out" condition traffic volumes.
- The 2039 "Proposed Zoning Build Out" condition traffic volumes were derived by subtracting the existing zoning trips from the 2039 "Existing Zoning Build Out" traffic volumes and then adding the proposed zoning trips.
- The 2039 "Existing Zoning Build Out" and 2039 "Proposed Zoning Build Out" conditions were analyzed and compared to each other to determine the traffic impacts of the rezone.

DEVELOPMENT PLANS

As previously stated, the proposed project site is approximately 2,619,263 square feet which is 60.13 acres. The build out of the existing BP zoning was based on a floor area ratio (FAR) of 0.25. Applying this FAR to the size of the project site yields a build out of 654,815 square feet of business park space. For trip generation purposes the build out of the existing zoning was assumed to be general office use.

The proposed CC zoning portion of the project site is 304,920 square feet which is 7.0 acres. The build out of the proposed CC zoning portion of the project was based on a floor area ratio (FAR) of 0.25. Applying this FAR to the size of the proposed commercial portion of the project site yields a build out of 76,230 square feet of commercial space.

The proposed R1-10 zoning portion of the project site is 53.13 acres. The build out of the proposed R1-10 zoning portion of the project site was based on Clark County Code (CCC) Table 40.220.010-4. Based on CCC Table 40.220.010-4, the maximum density for the R1-10 zoning is 3.5 dwelling units per acre. Applying the maximum density for the R1-10 zoning to the size of the proposed R1-10 portion of the project site yields a build out of 185 single-family detached dwelling units.

TRIP GENERATION

Estimates of daily, A.M. peak hour, and P.M. peak hour trips generated by the build out of the existing and proposed zonings were developed from rates published in “Trip Generation, 10th Edition” (Institute of Transportation Engineers, 2017). The build out of the existing zoning is expected to generate 4,292 daily, 511 A.M. peak hour (341 in, 170 out), and 508 P.M. peak hour (85 in, 423 out) net new trips. The build out of the proposed zoning is expected to generate 3,914 daily, 214 A.M. peak hour (87 in, 127 out), and 343 P.M. peak hour (182 in, 161 out) net new trips. The proposed zoning is expected to generate 378 less daily, 297 less A.M. peak hour (-254 in, -43 out), and 165 less P.M. peak hour (+97 in, -262 out) net new trips. The increase in trips generated by the build out of the proposed rezone is negligible compared to the existing zoning impacts and is summarized in Table 3.

Table 3. Trip Generation for Riverview Asset 2nd Annual Review Rezone

Land Use	Amount	Average Daily	A.M. Peak			P.M. Peak		
			In	Out	Total	In	Out	Total
Existing Zoning (BP) – Industrial Park – (ITE Code 110)								
Rate per 1,000 square feet (ksf)		3.37	0.04	0.36	0.40	0.08	0.32	0.40
Trips	327.408 ksf	1,103	13	118	131	26	105	131
Existing Zoning (BP) – General Office – (ITE Code 710)								
Rate per 1,000 square feet (ksf)		9.74	1.00	0.16	1.16	0.18	0.97	1.15
Trips	327.408 ksf	3,189	328	52	380	59	318	377
Net Total Trips for Existing Zoning		4,292	341	170	511	85	423	508
Proposed Zoning (R1-10) – Single-Family Detached – (ITE Code 210)								
Rate per dwelling unit		9.44	0.18	0.56	0.74	0.62	0.37	0.99
Trips	185 units	1,746	33	104	137	115	68	183
Proposed Zoning (CC) – General Office – (ITE Code 710)								
Rate per 1,000 square feet (ksf)		9.74	1.00	0.16	1.16	0.18	0.97	1.15
Trips	22.869 ksf	223	23	4	27	4	22	26
Proposed Zoning (CC) – Shopping Center – (ITE Code 820)								
Rate per 1,000 square feet (ksf)		37.75	0.58	0.36	0.94	1.83	1.98	3.81
Trips	53.361 ksf	2,014	31	19	50	97	106	203
Pass-By – 34% P.M. Only		(69)	-	-	-	(34)	(35)	(69)
Net Total for Shopping Center Use		1,945	31	19	50	63	71	134
Net Total Trips for Proposed Zoning		3,914	87	127	214	182	161	343
Proposed Zoning Trip Decrease		-378	-254	-43	-297	+97	-262	-165

TRIP DISTRIBUTION AND ASSIGNMENT

A generalized peak hour trip distribution was developed from the select zone assignment from RTC’s regional model which can be referenced in Appendix D. Figure 4a shows the resulting trip distribution pattern and assignment of the trips generated by the build out of the existing zoning. Figure 4b shows the trip distribution pattern and assignment of the trips generated by the build out of the proposed zoning.

Riverview Asset 2nd Annual Review Rezone TIA
Clark County, WA

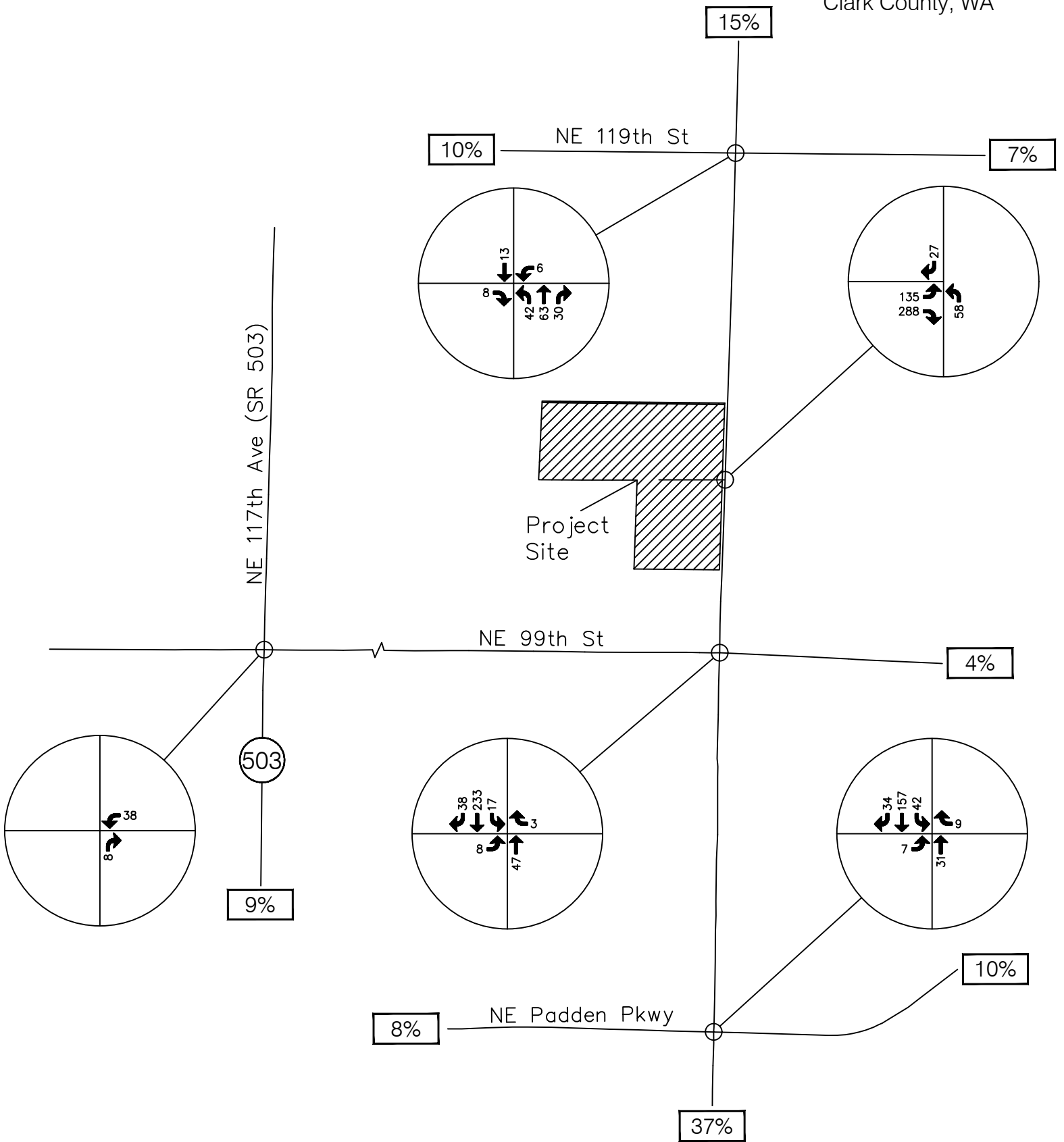

LEGEND

200 P.M. Peak Hour
Traffic Volume

10% Peak Hour Trip Distribution

FIGURE 4a
Existing Zoning (BP)
Trip Distribution and Assignment
Traffic Volumes

Riverview Asset 2nd Annual Review Rezone TIA
Clark County, WA

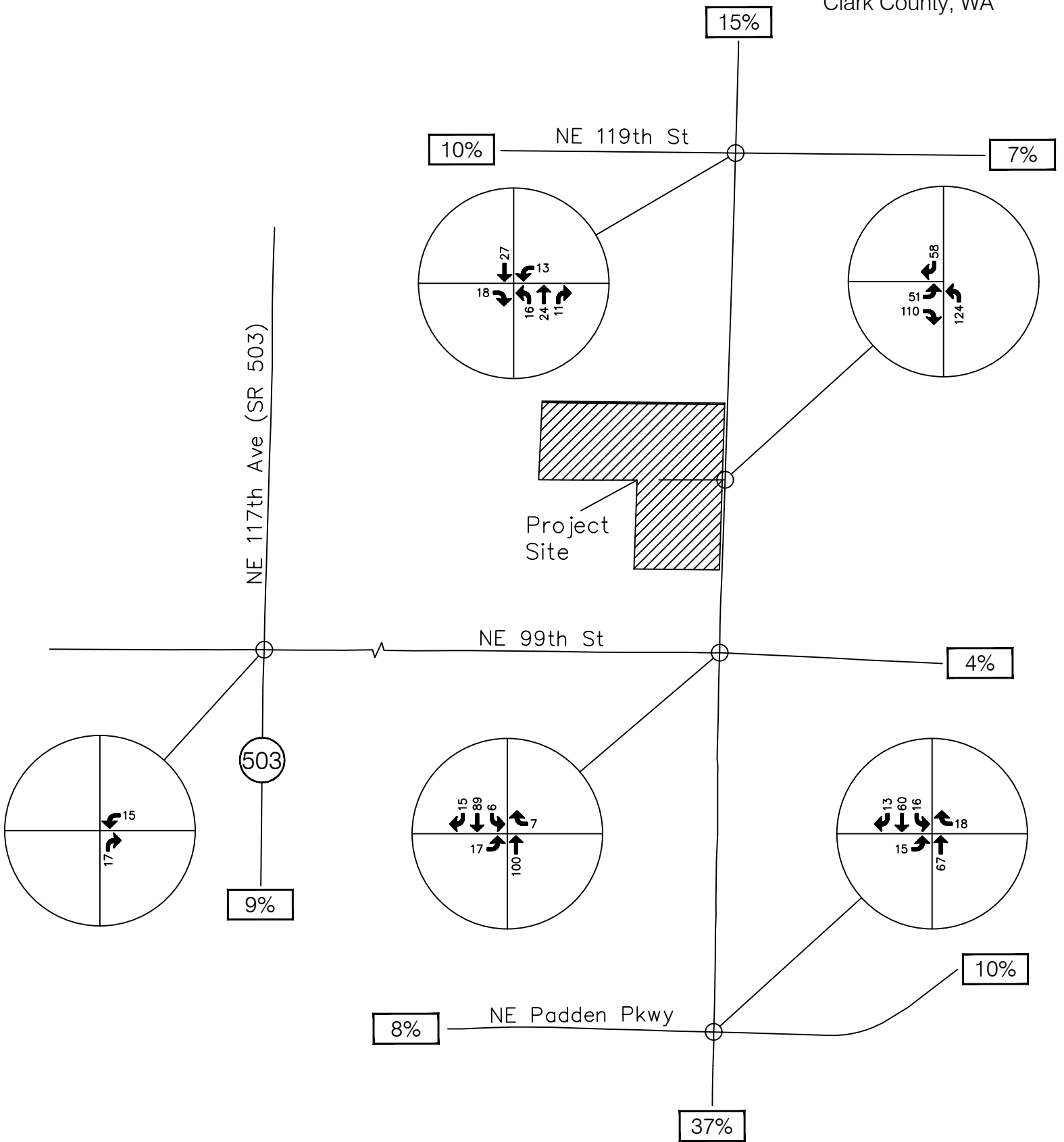

FIGURE 4b
Proposed Zoning (CC) & (R1-10)
Trip Distribution and Assignment
Traffic Volumes
19006_Figures.Dwg

NOT TO SCALE

2039 “EXISTING ZONING BUILD OUT” TRAFFIC VOLUMES AND LOS

The 2039 condition traffic volumes were derived from RTC’s 2035 regional transportation forecast model. The RTC model link volumes were post-processed to turning movement volumes based on the NCHRP 255 methodology and the TurnsW32 software. These 2035 post-processed turning movement traffic volumes were adjusted with a two (2) percent compounded annual growth factor to adjust the volumes to the 2039 analysis year. Since the RTC model included the build out of the project site assuming the existing zoning, these volumes represent the 2039 “Existing Zoning Build Out” condition traffic volumes. Figure 5 shows the “Existing Zoning Build Out” traffic volumes.

Levels of service were calculated at the study area intersections with the 2039 “Existing Zoning Build Out” traffic volumes shown in Figure 5 and the lane configurations shown previously in Figure 2. Appendix E contains the levels of service worksheets for the 2039 “Existing Zoning Build Out” condition.

The 2039 “Existing Zoning Build Out” P.M. peak hour levels of service at the study area intersections are summarized in Table 4a. As shown in Table 4a, all of the signalized intersection individual movements are projected to operate within Clark County’s concurrency standard of an average delay of less than two (2) cycle lengths or two hundred forty (240) seconds (whichever is less). The unsignalized study area intersection is projected to operate at LOS E in the 2039 “Existing Zoning Build Out” condition.

Part of the traffic study requirements is to calculate v/c ratios of the roadway segments identified in the pre-application conference report per CCC 40.350.020.G.1.a and Table 40.350.020-1. Table 4b summarizes the v/c ratios for the study area roadway segments for the 2039 "Existing Zoning Build Out" condition. The peak hour traffic volumes were taken from Figure 5 and the capacities were based on the roadway functional classifications and CCC Table 40.350.020-1. Per CCC 40.350.020.G.1.a, the study area roadway segment v/c ratio standard is 0.90. As shown in Table 4b, all of the study area roadway segment v/c ratios are all within the acceptable standard in the 2039 "Existing Zoning Build Out" condition.

Table 4a. 2039 "Existing Zoning Build Out" Levels of Service Continued

Signalized Intersection	P.M. Peak Hour	
	LOS	Average Delay (sec)
NE 152 nd Avenue/NE 119 th Street		
Eastbound Approach	B	17.9
Westbound Approach	B	14.0
Northbound Approach	B	12.5
Southbound Approach	A	8.0
Overall	B	13.0
NE 117 th Avenue (SR 503)/NE 99 th Street		
Eastbound Left	E	63.1
Eastbound Through	D	49.3
Eastbound Right	D	42.6
Westbound Left	F	81.5
Westbound Through	D	44.9
Westbound Right	D	36.5
Northbound Left	B	13.7
Northbound Through	C	33.8
Northbound Right	B	12.1
Southbound Left	E	64.3
Southbound Through	B	14.0
Southbound Right	A	6.0
Overall	C	33.4
NE 152 nd Avenue/NE Padden Parkway		
Eastbound Left	D	47.6
Eastbound Through	D	51.9
Eastbound Right	B	14.1
Westbound Left	F	92.9
Westbound Through	D	38.3
Westbound Right	B	16.6
Northbound Left	C	22.5
Northbound Through/Right	D	48.6
Southbound Left	C	31.5
Southbound Through	C	30.3
Southbound Right	C	29.1
Overall	D	39.0
All-Way Stop Intersection		
NE 152 nd Avenue/NE 99 th Street	E	48.6

Table 4b. 2039 "Existing Zoning Build Out" V/C Ratios for Study Area Roadway Segment

Roadway Segment	P.M. Peak Hour Volume	Capacity	P.M. V/C Ratio
NE 119 th Street			
West of NE 152 nd Avenue – EB	432	900	0.48
West of NE 152 nd Avenue – WB	459	900	0.51
East of NE 152 nd Avenue – EB	302	900	0.34
East of NE 152 nd Avenue – WB	256	900	0.28
NE 152 nd Avenue			
North of NE 119 th Street – NB	511	800	0.64
North of NE 119 th Street – SB	388	800	0.49
NE 119 th Street to NE 99 th Street – NB ¹	695	800	0.87
NE 119 th Street to NE 99 th Street – SB ¹	469	800	0.58
NE 99 th Street to NE Padden Parkway – NB ¹	674	900 ²	0.75
NE 99 th Street to NE Padden Parkway – SB ¹	459	900 ²	0.51
NE 99 th Street			
SR 503 to NE 152 nd Avenue – EB ¹	502	900	0.56
SR 503 to NE 152 nd Avenue – WB ¹	295	900	0.33
East of NE 152 nd Avenue – EB	178	900	0.20
East of NE 152 nd Avenue – WB	60	900	0.07

¹The traffic volume is the average of the upstream and downstream traffic volumes of the roadway segment.

²This roadway segment has a future TIP project that will improve the roadway to C-2cb standard with a capacity of 900.

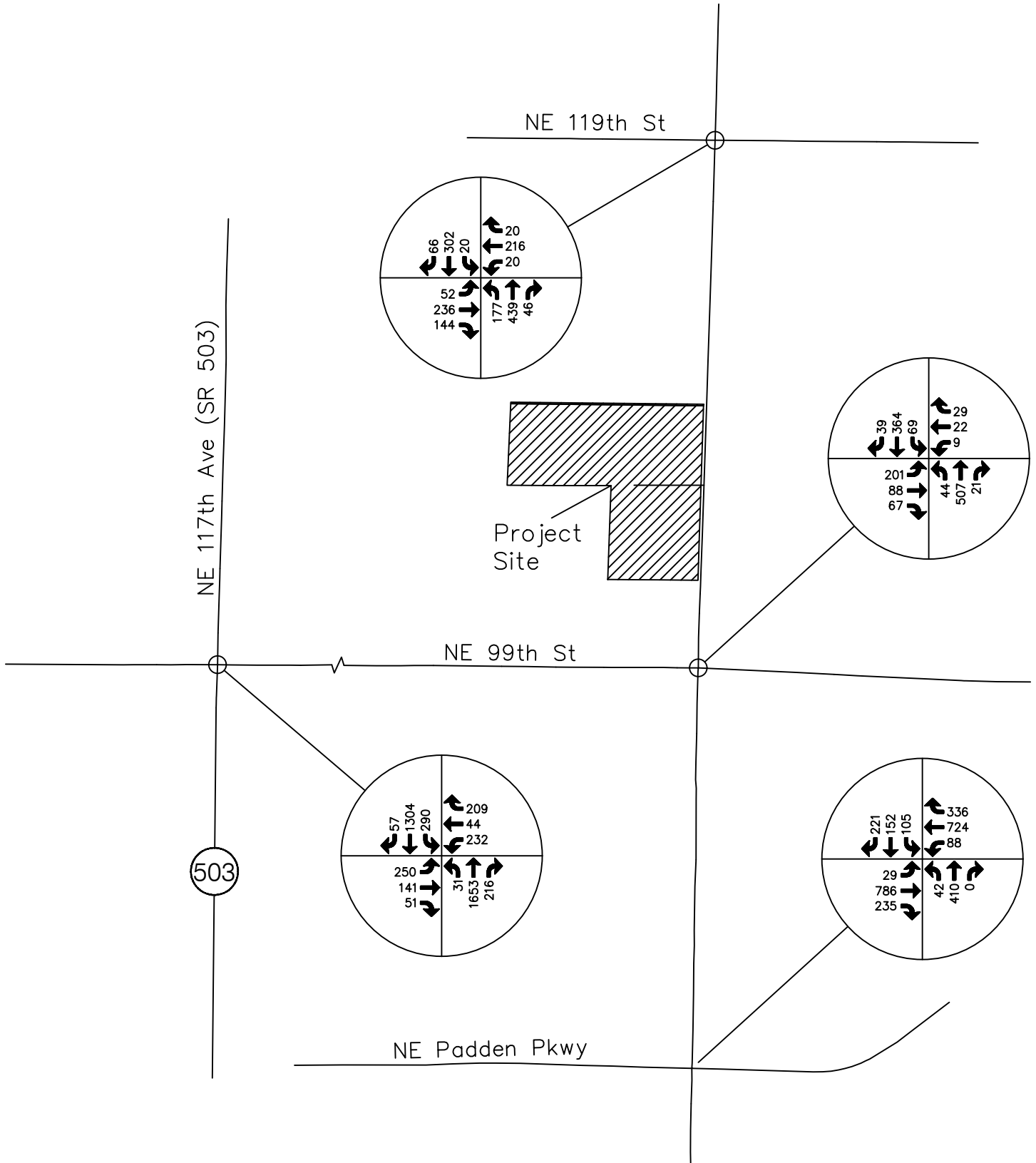

LEGEND

200

P.M. Peak Hour
Traffic Volume

FIGURE 5
2039 "Existing Zoning Build Out"
P.M. Peak Hour Traffic Volumes

2039 “PROPOSED ZONING BUILD OUT” TRAFFIC VOLUMES AND LOS

The 2039 “Proposed Zoning Build Out” condition traffic volumes were derived by subtracting the existing zoning trips (Figure 4a) from the 2039 “Existing Zoning Build Out” traffic volumes and then adding the proposed zoning trips (Figure 4b). Figure 6 shows the 2039 “Proposed Zoning Build Out” traffic volumes. Levels of service were calculated at the study area intersections with the 2039 “Proposed Zoning Build Out” traffic volumes shown in Figure 6 and the lane configurations shown earlier in Figure 2. Appendix G contains the levels of service worksheets for the 2039 “Proposed Zoning Build Out” condition.

The 2039 “Proposed Zoning Build Out” P.M. peak hour levels of service at the study area intersections are summarized in Table 5a. As shown in Table 5a, all of the signalized intersection individual movements are projected to operate within Clark County’s concurrency standard of an average delay of less than two (2) cycle lengths or two hundred forty (240) seconds (whichever is less). The unsignalized study area intersection is projected to operate at LOS E in the 2039 “Proposed Zoning Build Out” condition.

Part of the traffic study requirements is to calculate v/c ratios of the roadway segments identified in the pre-application conference report per CCC 40.350.020.G.1.a and Table 40.350.020-1. Table 5b summarizes the v/c ratios for the study area roadway segments for the 2039 "Proposed Zoning Build Out" condition. The peak hour traffic volumes were taken from Figure 6 and the capacities were based on the roadway functional classifications and CCC Table 40.350.020-1. Per CCC 40.350.020.G.1.a, the study area roadway segment v/c ratio standard is 0.90. As shown in Table 5b, all of the study area roadway segment v/c ratios are all within the acceptable standard in the 2039 "Proposed Zoning Build Out" condition.

Table 5a. 2039 “Proposed Zoning Build Out” Levels of Service

Signalized Intersection	P.M. Peak Hour	
	LOS	Average Delay (sec)
NE 152 nd Avenue/NE 119 th Street		
Eastbound Approach	B	15.1
Westbound Approach	B	12.1
Northbound Approach	B	10.5
Southbound Approach	A	8.4
Overall	B	11.5
NE 117 th Avenue (SR 503)/NE 99 th Street		
Eastbound Left	E	63.2
Eastbound Through	D	49.4
Eastbound Right	D	42.6
Westbound Left	E	65.0
Westbound Through	D	44.9
Westbound Right	D	36.5
Northbound Left	B	13.7
Northbound Through	C	33.8
Northbound Right	B	12.2
Southbound Left	E	64.4
Southbound Through	B	14.0
Southbound Right	A	6.0
Overall	C	32.4
NE 152 nd Avenue/NE Padden Parkway		
Eastbound Left	D	50.7
Eastbound Through	D	51.9
Eastbound Right	B	14.1
Westbound Left	F	92.9
Westbound Through	D	38.3
Westbound Right	B	16.8
Northbound Left	C	22.1
Northbound Through/Right	E	58.3
Southbound Left	C	30.5
Southbound Through	C	27.3
Southbound Right	C	28.2
Overall	D	40.9
All-Way Stop Intersection		
NE 152 nd Avenue/NE 99 th Street	E	47.7

Table 5b. 2039 "Proposed Zoning Build Out" V/C Ratios for Study Area Roadway Segment

Roadway Segment	P.M. Peak Hour Volume	Capacity	P.M. V/C Ratio
NE 119 th Street			
West of NE 152 nd Avenue – EB	442	900	0.49
West of NE 152 nd Avenue – WB	433	900	0.48
East of NE 152 nd Avenue – EB	283	900	0.31
East of NE 152 nd Avenue – WB	263	900	0.29
NE 152 nd Avenue			
North of NE 119 th Street – NB	472	800	0.59
North of NE 119 th Street – SB	402	800	0.50
NE 119 th Street to NE 99 th Street – NB ¹	691	800	0.86
NE 119 th Street to NE 99 th Street – SB ¹	396	800	0.50
NE 99 th Street to NE Padden Parkway – NB ¹	727	900 ²	0.81
NE 99 th Street to NE Padden Parkway – SB ¹	315	900 ²	0.35
NE 99 th Street			
SR 503 to NE 152 nd Avenue – EB ¹	511	900	0.57
SR 503 to NE 152 nd Avenue – WB ¹	272	900	0.30
East of NE 152 nd Avenue – EB	167	900	0.19
East of NE 152 nd Avenue – WB	64	900	0.07

¹The traffic volume is the average of the upstream and downstream traffic volumes of the roadway segment.

²This roadway segment has a future TIP project that will improve the roadway to C-2cb standard with a capacity of 900.

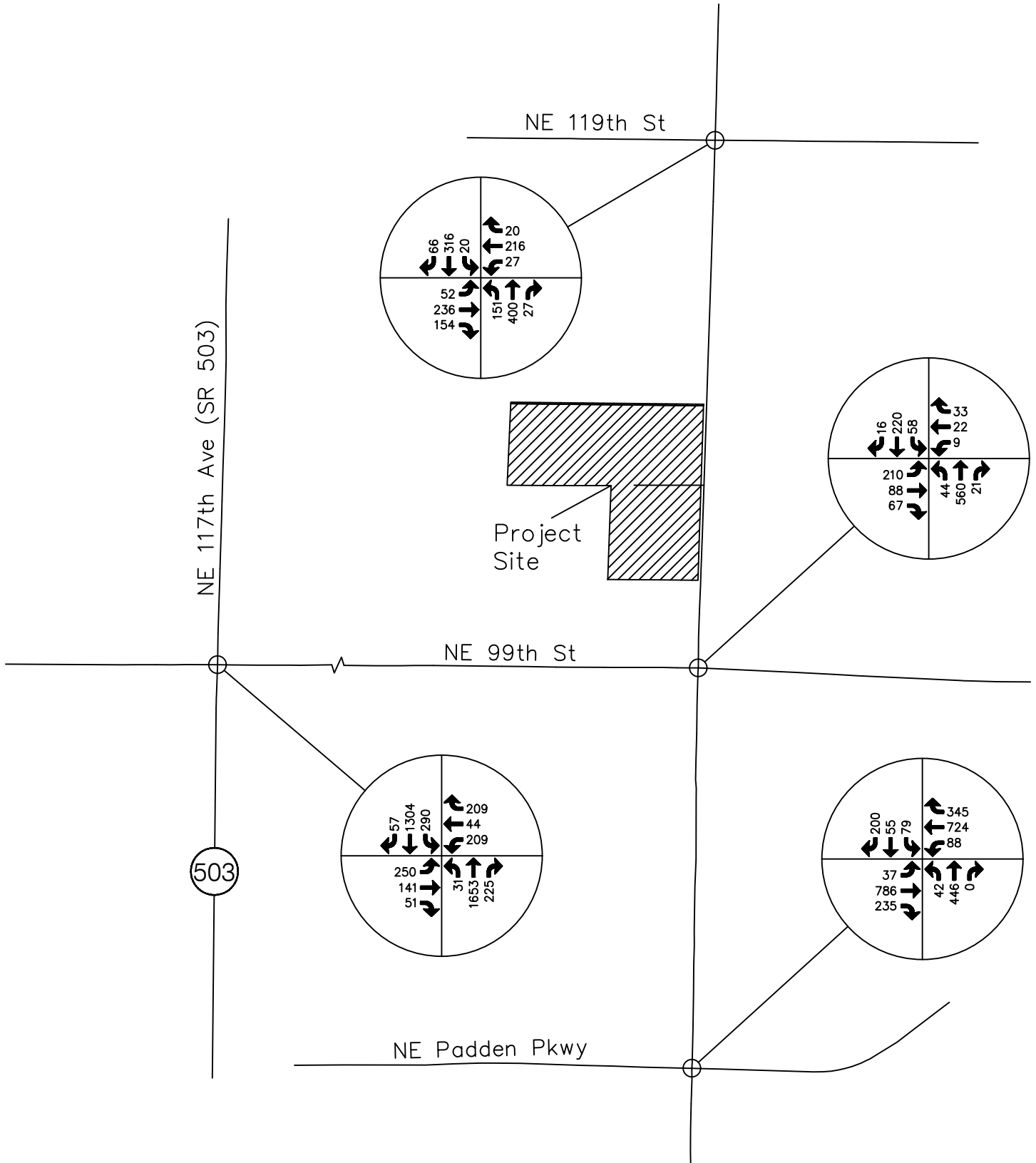

LEGEND

200

P.M. Peak Hour
Traffic Volume

FIGURE 6
2039 "Proposed Zoning Build Out"
P.M. Peak Hour Traffic Volumes

SIGNAL WARRANT ANALYSIS

Typically multiple signal warrants are necessary to be met for a traffic signal to be installed. The following three MUTCD warrants are normally analyzed to justify a signal installation:

- Warrant 1 – Eight-Hour Vehicular Volume: This warrant is intended to be applied under one of three conditions. The first condition is based on minimum vehicular volume in which a large volume of intersecting traffic is the principal reason to consider signalization. The second condition is based on interruption of continuous traffic in which the traffic on the major street is so heavy that the intersecting street traffic suffers excessive delays or conflicts. The third condition is the combination of the first two conditions.
- Warrant 2 – Four-Hour Vehicular Volume: This warrant is intended to be applied where cross traffic to the major street is the primary consideration for installing a traffic signal.
- Warrant 3 – Peak Hour: This warrant is intended for use at a location where traffic conditions are such that in the peak hour(s) of an average day, the minor street approach suffers significant delay when entering or crossing the major street.

Warrant 1- Eight Hour Vehicular Volume

Condition A of Warrant 1 is known as the minimum vehicular volume condition. It is intended to be applied at locations where a large volume of intersecting traffic is the principal reason to consider installing a traffic signal. For Condition A to be met, the condition outlined in the MUTCD must be met for any eight hours at the intersection in question.

Condition B of Warrant 1 is known as the interruption of continuous traffic condition. It is intended to be applied at locations where Condition A is not satisfied and where the traffic volume on a major street is so heavy that traffic on the minor intersecting street suffers excessive delay or conflict in entering or crossing the major street. For Condition B to be met, the condition outlined in the MUTCD must be met for any eight hours at the intersection in question.

The combination of Conditions A and B was labeled as Condition C. It is intended to be applied where both Conditions A and B are not satisfied and should only be applied after alternatives to signalization have failed.

Warrant 2 – Four Hour Vehicular Volume

Warrant 2 is intended to be applied where the volume of the intersecting traffic is the principal reason to consider installing a signal. For Warrant 2 to be met, the condition outlined in the MUTCD must be met for any four hours.

Warrant 3 – Peak Hour

Warrant 3 is intended to be applied at a location where traffic conditions are such that for a minimum of one hour of an average day, the minor street traffic suffers undue delay when entering or crossing the major street.

There are two general categories of how the peak hour warrant is met and they are described below:

- MUTCD Section 4C.04.A.
Warrant 3, the peak hour warrant, is met when all three conditions exist for the same one hour (any four consecutive 15-minute periods) of an average day:
 1. The total stopped time delay experienced by the traffic on one minor street approach (one direction only) controlled by a stop sign equals or exceeds 4-vehicle hours for a one lane approach or 5 vehicle hours for a two lane approach.
 2. The volume on the same minor street approach (one direction only) equals or exceeds 100 vehicles per hour for one moving lane of traffic or 150 vehicles per hour for two moving lanes.
 3. The total entering volume serviced during the hour equals or exceeds 650 vehicles per hour for intersections with three approaches or 800 vehicles per hour for intersections with four or more approaches.

- MUTCD Section 4C.04.B.
The plotted point representing the vehicles per hour on the major street (total of both approaches) and the corresponding vehicles per hour on the higher volume minor street approach (one direction only) for one hour (any four consecutive 15-minute periods) of an average day falls above the applicable curve in Figure 4C-3 (of the 2009 Manual of Uniform Traffic Control Devices) for the existing combination of approach lanes.

For this analysis, Figure 4C-3 was utilized for Warrant 3, the Peak Hour signal warrant.

Since only peak hour counts were conducted for this traffic impact analysis, only the Warrant 3 – Peak Hour signal warrant analysis was conducted for the NE 152nd Avenue/NE 99th Street intersection. This initial signal warrant analysis only serves as a preliminary determination whether further analysis is needed to conduct Warrants 1 and 2. Table 6 summarizes the results of Warrant 3 – Peak Hour signal warrant analysis.

As shown in Table 6, Warrant 3 – Peak Hour is met in both the 2039 “Existing Zoning Build Out” and the 2039 “Proposed Zoning Build Out” conditions. The preliminary determination is that further signal warrant analyses (Warrants 1 and 2) should be conducted prior to reaching the conclusion that a signal is warranted at the NE 152nd Avenue/NE 99th Street intersection.

Table 6. 2039 P.M. Peak Hour Signal Warrant Summary at NE 152nd Avenue/NE 99th Street

Intersection & Time Period	Approach Volume Totals		Minor Volume Required to meet Warrant	Is Warrant Met?
	Major Approach Total	Minor Max ¹		
2039 “Existing Zoning Build Out”	1,044	356	195	Yes
2039 “Proposed Zoning Build Out”	919	365	245	Yes

While the cursory signal warrant analysis indicates that a traffic signal may need to be installed in any 2039 condition, for this rezone analysis the main issue is the impact of the rezone proposed on current transportation facilities and whether adequate facilities exist. First, the rezone build out traffic impacts are projected to be less than the existing zoning build out and could lessen additional infrastructure needs. Second, should a signal be required in the future at the NE 152nd Avenue/NE 99th Street intersection, that potential mitigation is well within the future development’s ability to mitigate as part of a condition of approval.

CONCLUSIONS

The following are the findings and recommendations from the traffic analysis:

Findings

- The “Existing Zoning Build Out” is expected to generate 4,292 daily, 511 A.M. peak hour (341 in, 170 out), and 508 P.M. peak hour (85 in, 423 out) net new trips.

The “Proposed Zoning Build Out” is expected to generate 3,914 daily, 214 A.M. peak hour (87 in, 127 out), and 343 P.M. peak hour (182 in, 161 out) net new trips.

The “Proposed Zoning Build Out” is expected to generate 378 less daily, 297 less A.M. peak hour (-254 in, -43 out), and 165 less P.M. peak hour (+97 in, -262 out) net new trips. The increase in trips generated by the build out of the proposed rezone is negligible compared to the existing zoning impacts.

- The study area intersections are projected to operate at acceptable levels of service in the 2039 “Existing Zoning Build Out” and 2039 “Proposed Zoning Build Out” conditions.
- All of the study area roadway segment v/c ratios are all within the acceptable standard in the 2039 “Existing Zoning Build Out” and 2039 “Proposed Zoning Build Out” conditions.
- While the cursory signal warrant analysis indicates that a traffic signal may need to be installed in any 2039 condition, for this rezone analysis the main issue is the impact of the rezone proposed on current transportation facilities and whether adequate facilities exist. First, the rezone build out traffic impacts are projected to be less than the existing zoning build out and could lessen additional infrastructure needs. Second, should a signal be required in the future at the NE 152nd Avenue/NE 99th Street intersection, that potential mitigation is well within the future development’s ability to mitigate as part of a condition of approval.

Recommendations

- Based on the traffic impact analysis documented in this report, no physical, off-site mitigation would be needed.
- Based on the traffic impact analysis documented in this report, the rezoning of the Riverview Asset property will not result in any significant degradation in traffic conditions in the project vicinity.

APPENDIX A
TRAFFIC COUNTS

Intersection: NE 152nd Avenue/NE 119th Street
 PM Peak Hour Turning Movement Volumes

Date: 10/30/18

Time	<u>SB</u>				<u>WB</u>				<u>NB</u>				<u>EB</u>				Total
	SBR	SBT	SBL	Trucks	WBR	WBT	WBL	Trucks	NBR	NBT	NBL	Trucks	EBR	EBT	EBL	Trucks	
<u>15 Minute Totals</u>																	
4:00 - 4:15 PM	6	50	5	1	8	23	7	2	8	58	16	1	20	29	4	2	234
4:15 - 4:30 PM	5	59	1	5	6	10	0	0	2	51	22	1	26	34	5	2	221
4:30 - 4:45 PM	4	37	6	2	1	23	1	2	1	57	19	0	18	26	8	0	201
4:45 - 5:00 PM	10	46	3	0	3	33	3	2	7	67	27	4	22	36	8	1	265
5:00 - 5:15 PM	5	55	2	0	1	28	1	2	0	60	20	0	30	35	6	1	243
5:15 - 5:30 PM	7	51	1	0	3	19	1	1	3	54	30	1	32	39	10	3	250
5:30 - 5:45 PM	7	40	1	1	4	29	4	0	1	55	27	0	20	27	11	0	226
5:45 - 6:00 PM	6	24	4	1	2	16	3	0	6	48	25	1	25	17	4	0	180
Peak 15 Total																265	
<u>Hourly Total by 15 minutes</u>																	
4:00 - 5:00 PM	25	192	15	8	18	89	11	6	18	233	84	6	86	125	25	5	921
4:15 - 5:15 PM	24	197	12	7	11	94	5	6	10	235	88	5	96	131	27	4	930
4:30 - 5:30 PM	26	189	12	2	8	103	6	7	11	238	96	5	102	136	32	5	959
4:45 - 5:45 PM	29	192	7	1	11	109	9	5	11	236	104	5	104	137	35	5	984
5:00 - 6:00 PM	25	170	8	2	10	92	9	3	10	217	102	2	107	118	31	4	899
Peak Hour 4:45 - 5:45 PM	29	192	7	1	11	109	9	5	11	236	104	5	104	137	35	5	984
Peak Hour Factor	0.92				0.83				0.87				0.85				0.93
Peak Hour % Trucks	0%				4%				1%				2%				
Peak 15 Min % Trucks	0%				5%				4%				2%				

Intersection: NE 117th Avenue (SR 503)/NE 99th Street
 PM Peak Hour Turning Movement Volumes

Date: 09/12/18

Time	<u>SB</u>				<u>WB</u>				<u>NB</u>				<u>EB</u>				Total
	SBR	SBT	SBL	Trucks	WBR	WBT	WBL	Trucks	NBR	NBT	NBL	Trucks	EBR	EBT	EBL	Trucks	
<u>15 Minute Totals</u>																	
4:00 - 4:15 PM	21	154	35	11	27	24	60	1	40	258	24	14	14	15	37	0	709
4:15 - 4:30 PM	25	212	33	11	34	15	38	3	43	299	18	14	7	23	38	0	785
4:30 - 4:45 PM	17	166	24	6	42	16	40	1	47	326	18	10	9	15	36	1	756
4:45 - 5:00 PM	20	144	40	4	52	26	44	1	40	305	25	11	10	30	37	1	773
5:00 - 5:15 PM	8	148	35	7	50	20	54	2	39	305	15	6	13	30	53	0	770
5:15 - 5:30 PM	20	195	37	9	45	27	60	1	43	319	17	8	11	26	45	3	845
5:30 - 5:45 PM	23	189	31	6	46	24	49	1	43	278	25	4	15	27	39	1	789
5:45 - 6:00 PM	24	176	24	4	30	20	43	1	43	275	20	6	14	20	36	0	725
															Peak 15 Total		845
<u>Hourly Total by 15 minutes</u>																	
4:00 - 5:00 PM	83	676	132	32	155	81	182	6	170	1,188	85	49	40	83	148	2	3,023
4:15 - 5:15 PM	70	670	132	28	178	77	176	7	169	1,235	76	41	39	98	164	2	3,084
4:30 - 5:30 PM	65	653	136	26	189	89	198	5	169	1,255	75	35	43	101	171	5	3,144
4:45 - 5:45 PM	71	676	143	26	193	97	207	5	165	1,207	82	29	49	113	174	5	3,177
5:00 - 6:00 PM	75	708	127	26	171	91	206	5	168	1,177	77	24	53	103	173	4	3,129
Peak Hour 4:45 - 5:45 PM	71	676	143	26	193	97	207	5	165	1207	82	29	49	113	174	5	3,177
Peak Hour Factor		0.88				0.94				0.96				0.88			0.94
Peak Hour % Trucks		3%				1%				2%				1%			
Peak 15 Min % Trucks		4%				1%				2%				4%			

Intersection: NE 152nd Avenue/NE Padden Parkway
 PM Peak Hour Turning Movement Volumes

Date: 10/31/18

Time	<u>SB</u>				<u>WB</u>				<u>NB</u>				<u>EB</u>				Total
	SBR	SBT	SBL	Trucks	WBR	WBT	WBL	Trucks	NBR	NBT	NBL	Trucks	EBR	EBT	EBL	Trucks	
<u>15 Minute Totals</u>																	
4:00 - 4:15 PM	45	59	32	11	31	106	43	9	2	58	15	0	47	136	7	7	581
4:15 - 4:30 PM	37	59	22	3	26	131	52	5	4	58	15	3	36	159	1	1	600
4:30 - 4:45 PM	26	56	26	7	30	114	45	5	2	51	14	0	51	136	1	1	552
4:45 - 5:00 PM	24	56	36	3	26	133	44	4	7	59	10	2	57	140	2	2	594
5:00 - 5:15 PM	31	58	24	3	32	100	43	2	1	44	9	0	47	139	0	0	528
5:15 - 5:30 PM	29	70	33	2	32	145	62	3	1	78	17	0	59	134	1	1	661
5:30 - 5:45 PM	38	62	27	0	26	125	64	3	5	70	16	1	58	142	1	1	634
5:45 - 6:00 PM	30	39	21	0	28	135	41	0	2	52	8	1	48	133	2	2	539
																	661
<u>Hourly Total by 15 minutes</u>																	
4:00 - 5:00 PM	132	230	116	24	113	484	184	23	15	226	54	5	191	571	11	11	2,327
4:15 - 5:15 PM	118	229	108	16	114	478	184	16	14	212	48	5	191	574	4	4	2,274
4:30 - 5:30 PM	110	240	119	15	120	492	194	14	11	232	50	2	214	549	4	4	2,335
4:45 - 5:45 PM	122	246	120	8	116	503	213	12	14	251	52	3	221	555	4	4	2,417
5:00 - 6:00 PM	128	229	105	5	118	505	210	8	9	244	50	2	212	548	4	4	2,362
Peak Hour 4:45 - 5:45 PM	122	246	120	8	116	503	213	12	14	251	52	3	221	555	4	4	2,417
Peak Hour Factor		0.92				0.87				0.83				0.97			0.91
Peak Hour % Trucks		2%				1%				1%				1%			
Peak 15 Min % Trucks		2%				1%				0%				1%			

Intersection: NE 152nd Avenue/NE 99th Street
 PM Peak Hour Turning Movement Volumes

Date: 10/30/18

Time	<u>SB</u>				<u>WB</u>				<u>NB</u>				<u>EB</u>				Total
	SBR	SBT	SBL	Trucks	WBR	WBT	WBL	Trucks	NBR	NBT	NBL	Trucks	EBR	EBT	EBL	Trucks	
<u>15 Minute Totals</u>																	
4:00 - 4:15 PM	12	40	10	2	10	18	3	2	7	75	25	0	30	24	18	4	272
4:15 - 4:30 PM	26	57	3	3	9	13	6	0	11	74	29	1	21	24	29	4	302
4:30 - 4:45 PM	13	64	8	5	7	18	0	1	9	83	17	0	19	24	35	1	297
4:45 - 5:00 PM	10	56	9	1	8	18	2	0	4	72	22	3	18	20	16	4	255
5:00 - 5:15 PM	21	56	5	1	9	16	2	3	8	87	17	1	22	31	16	3	290
5:15 - 5:30 PM	15	76	5	1	8	9	1	0	2	66	21	0	22	23	23	1	271
5:30 - 5:45 PM	7	68	11	0	7	18	6	0	9	92	28	2	19	21	21	2	307
5:45 - 6:00 PM	5	59	8	0	10	13	2	0	7	82	25	2	15	21	17	1	264
																	307
<u>Hourly Total by 15 minutes</u>																	
4:00 - 5:00 PM	61	217	30	11	34	67	11	3	31	304	93	4	88	92	98	13	1,126
4:15 - 5:15 PM	70	233	25	10	33	65	10	4	32	316	85	5	80	99	96	12	1,144
4:30 - 5:30 PM	59	252	27	8	32	61	5	4	23	308	77	4	81	98	90	9	1,113
4:45 - 5:45 PM	53	256	30	3	32	61	11	3	23	317	88	6	81	95	76	10	1,123
5:00 - 6:00 PM	48	259	29	2	34	56	11	3	26	327	91	5	78	96	77	7	1,132
Peak Hour 4:15 - 5:15 PM	70	233	25	10	33	65	10	4	32	316	85	5	80	99	96	12	1,144
Peak Hour Factor		0.95				0.96				0.95				0.88			0.95
Peak Hour % Trucks		3%				4%				1%				4%			
Peak 15 Min % Trucks		0%				0%				2%				3%			

APPENDIX B

EXISTING LEVELS OF SERVICE

Lanes, Volumes, Timings
1: NE 152nd Avenue & NE 119th Street

02/12/2019



Lane Group	EBL	EBT	EBR	WBL	WBT	WBR	NBL	NBT	NBR	SBL	SBT	SBR
Lane Configurations		↕			↕			↕			↕	
Traffic Volume (vph)	32	144	88	12	132	12	108	268	28	12	184	40
Future Volume (vph)	32	144	88	12	132	12	108	268	28	12	184	40
Ideal Flow (vphpl)	1900	1900	1900	1900	1900	1900	1900	1900	1900	1900	1900	1900
Lane Util. Factor	1.00	1.00	1.00	1.00	1.00	1.00	1.00	1.00	1.00	1.00	1.00	1.00
Frt		0.955			0.990			0.991			0.977	
Flt Protected		0.994			0.996			0.987			0.997	
Satd. Flow (prot)	0	1768	0	0	1784	0	0	1787	0	0	1851	0
Flt Permitted		0.946			0.963			0.853			0.975	
Satd. Flow (perm)	0	1683	0	0	1725	0	0	1544	0	0	1810	0
Right Turn on Red			Yes			Yes			Yes			Yes
Satd. Flow (RTOR)		46			8			9			25	
Link Speed (mph)		50			50			35			40	
Link Distance (ft)		2778			2259			4539			916	
Travel Time (s)		37.9			30.8			88.4			15.6	
Peak Hour Factor	1.00	1.00	1.00	1.00	1.00	1.00	1.00	1.00	1.00	1.00	1.00	1.00
Heavy Vehicles (%)	2%	2%	2%	5%	5%	5%	4%	4%	4%	0%	0%	0%
Adj. Flow (vph)	32	144	88	12	132	12	108	268	28	12	184	40
Shared Lane Traffic (%)												
Lane Group Flow (vph)	0	264	0	0	156	0	0	404	0	0	236	0
Enter Blocked Intersection	No	No	No	No	No	No	No	No	No	No	No	No
Lane Alignment	Left	Left	Right	Left	Left	Right	Left	Left	Right	Left	Left	Right
Median Width(ft)		0			0			0			0	
Link Offset(ft)		0			0			0			0	
Crosswalk Width(ft)		16			16			16			16	
Two way Left Turn Lane												
Headway Factor	1.00	1.00	1.00	1.00	1.00	1.00	1.00	1.00	1.00	1.00	1.00	1.00
Turning Speed (mph)	15		9	15		9	15		9	15		9
Number of Detectors	1	2		1	2		1	2		1	2	
Detector Template	Left	Thru		Left	Thru		Left	Thru		Left	Thru	
Leading Detector (ft)	20	100		20	100		20	100		20	100	
Trailing Detector (ft)	0	0		0	0		0	0		0	0	
Detector 1 Position(ft)	0	0		0	0		0	0		0	0	
Detector 1 Size(ft)	20	6		20	6		20	6		20	6	
Detector 1 Type	Cl+Ex	Cl+Ex		Cl+Ex	Cl+Ex		Cl+Ex	Cl+Ex		Cl+Ex	Cl+Ex	
Detector 1 Channel												
Detector 1 Extend (s)	0.0	0.0		0.0	0.0		0.0	0.0		0.0	0.0	
Detector 1 Queue (s)	0.0	0.0		0.0	0.0		0.0	0.0		0.0	0.0	
Detector 1 Delay (s)	0.0	0.0		0.0	0.0		0.0	0.0		0.0	0.0	
Detector 2 Position(ft)		94			94			94			94	
Detector 2 Size(ft)		6			6			6			6	
Detector 2 Type		Cl+Ex			Cl+Ex			Cl+Ex			Cl+Ex	
Detector 2 Channel												
Detector 2 Extend (s)		0.0			0.0			0.0			0.0	
Turn Type	Perm	NA		Perm	NA		Perm	NA		Perm	NA	
Protected Phases		4			8			2			6	
Permitted Phases	4			8			2			6		
Detector Phase	4	4		8	8		2	2		6	6	
Switch Phase												

Lanes, Volumes, Timings
 1: NE 152nd Avenue & NE 119th Street

02/12/2019



Lane Group	EBL	EBT	EBR	WBL	WBT	WBR	NBL	NBT	NBR	SBL	SBT	SBR
Minimum Initial (s)	5.0	5.0		5.0	5.0		5.0	5.0		5.0	5.0	
Minimum Split (s)	22.5	22.5		22.5	22.5		22.5	22.5		22.5	22.5	
Total Split (s)	25.0	25.0		25.0	25.0		35.0	35.0		35.0	35.0	
Total Split (%)	41.7%	41.7%		41.7%	41.7%		58.3%	58.3%		58.3%	58.3%	
Maximum Green (s)	20.5	20.5		20.5	20.5		30.5	30.5		30.5	30.5	
Yellow Time (s)	3.5	3.5		3.5	3.5		3.5	3.5		3.5	3.5	
All-Red Time (s)	1.0	1.0		1.0	1.0		1.0	1.0		1.0	1.0	
Lost Time Adjust (s)		0.0			0.0			0.0			0.0	
Total Lost Time (s)		4.5			4.5			4.5			4.5	
Lead/Lag												
Lead-Lag Optimize?												
Vehicle Extension (s)	3.0	3.0		3.0	3.0		3.0	3.0		3.0	3.0	
Recall Mode	None	None		None	None		Min	Min		Min	Min	
Walk Time (s)	7.0	7.0		7.0	7.0		7.0	7.0		7.0	7.0	
Flash Dont Walk (s)	11.0	11.0		11.0	11.0		11.0	11.0		11.0	11.0	
Pedestrian Calls (#/hr)	0	0		0	0		0	0		0	0	
Act Effect Green (s)		10.4			10.4			16.2			16.2	
Actuated g/C Ratio		0.29			0.29			0.45			0.45	
v/c Ratio		0.51			0.31			0.58			0.28	
Control Delay		13.1			12.0			11.6			7.1	
Queue Delay		0.0			0.0			0.0			0.0	
Total Delay		13.1			12.0			11.6			7.1	
LOS		B			B			B			A	
Approach Delay		13.1			12.0			11.6			7.1	
Approach LOS		B			B			B			A	

Intersection Summary

Area Type:	Other
Cycle Length:	60
Actuated Cycle Length:	36
Natural Cycle:	45
Control Type:	Actuated-Uncoordinated
Maximum v/c Ratio:	0.58
Intersection Signal Delay:	11.0
Intersection LOS:	B
Intersection Capacity Utilization:	68.0%
ICU Level of Service:	C
Analysis Period (min):	15

Splits and Phases: 1: NE 152nd Avenue & NE 119th Street

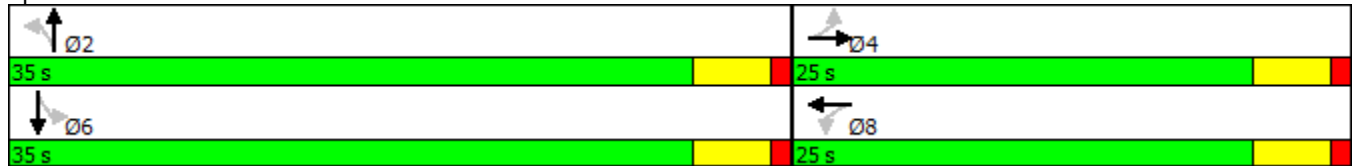

Queues

1: NE 152nd Avenue & NE 119th Street



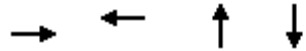













02/12/2019



Lane Group	EBT	WBT	NBT	SBT
Lane Group Flow (vph)	264	156	404	236
v/c Ratio	0.51	0.31	0.58	0.28
Control Delay	13.1	12.0	11.6	7.1
Queue Delay	0.0	0.0	0.0	0.0
Total Delay	13.1	12.0	11.6	7.1
Queue Length 50th (ft)	29	19	47	21
Queue Length 95th (ft)	102	68	138	66
Internal Link Dist (ft)	2698	2179	4459	836
Turn Bay Length (ft)				
Base Capacity (vph)	1019	1028	1338	1570
Starvation Cap Reductn	0	0	0	0
Spillback Cap Reductn	0	0	0	0
Storage Cap Reductn	0	0	0	0
Reduced v/c Ratio	0.26	0.15	0.30	0.15
Intersection Summary				

























HCM 2010 Signalized Intersection Summary
 1: NE 152nd Avenue & NE 119th Street

02/12/2019

												
Movement	EBL	EBT	EBR	WBL	WBT	WBR	NBL	NBT	NBR	SBL	SBT	SBR
Lane Configurations												
Traffic Volume (veh/h)	32	144	88	12	132	12	108	268	28	12	184	40
Future Volume (veh/h)	32	144	88	12	132	12	108	268	28	12	184	40
Number	7	4	14	3	8	18	5	2	12	1	6	16
Initial Q (Qb), veh	0	0	0	0	0	0	0	0	0	0	0	0
Ped-Bike Adj(A_pbT)	1.00		1.00	1.00		1.00	1.00		1.00	1.00		1.00
Parking Bus, Adj	1.00	1.00	1.00	1.00	1.00	1.00	1.00	1.00	1.00	1.00	1.00	1.00
Adj Sat Flow, veh/h/ln	1900	1863	1900	1900	1810	1900	1900	1827	1900	1900	1900	1900
Adj Flow Rate, veh/h	32	144	88	12	132	12	108	268	28	12	184	40
Adj No. of Lanes	0	1	0	0	1	0	0	1	0	0	1	0
Peak Hour Factor	1.00	1.00	1.00	1.00	1.00	1.00	1.00	1.00	1.00	1.00	1.00	1.00
Percent Heavy Veh, %	2	2	2	5	5	5	4	4	4	0	0	0
Cap, veh/h	179	268	150	158	409	35	288	494	46	152	601	125
Arrive On Green	0.26	0.26	0.26	0.26	0.26	0.26	0.41	0.41	0.41	0.41	0.41	0.41
Sat Flow, veh/h	116	1020	568	59	1555	135	295	1217	113	32	1481	309
Grp Volume(v), veh/h	264	0	0	156	0	0	404	0	0	236	0	0
Grp Sat Flow(s),veh/h/ln	1704	0	0	1749	0	0	1625	0	0	1822	0	0
Q Serve(g_s), s	0.5	0.0	0.0	0.0	0.0	0.0	1.8	0.0	0.0	0.0	0.0	0.0
Cycle Q Clear(g_c), s	3.6	0.0	0.0	1.9	0.0	0.0	5.0	0.0	0.0	2.4	0.0	0.0
Prop In Lane	0.12		0.33	0.08		0.08	0.27		0.07	0.05		0.17
Lane Grp Cap(c), veh/h	597	0	0	603	0	0	827	0	0	879	0	0
V/C Ratio(X)	0.44	0.00	0.00	0.26	0.00	0.00	0.49	0.00	0.00	0.27	0.00	0.00
Avail Cap(c_a), veh/h	1413	0	0	1438	0	0	1937	0	0	2152	0	0
HCM Platoon Ratio	1.00	1.00	1.00	1.00	1.00	1.00	1.00	1.00	1.00	1.00	1.00	1.00
Upstream Filter(I)	1.00	0.00	0.00	1.00	0.00	0.00	1.00	0.00	0.00	1.00	0.00	0.00
Uniform Delay (d), s/veh	8.7	0.0	0.0	8.1	0.0	0.0	6.2	0.0	0.0	5.5	0.0	0.0
Incr Delay (d2), s/veh	0.5	0.0	0.0	0.2	0.0	0.0	0.4	0.0	0.0	0.2	0.0	0.0
Initial Q Delay(d3),s/veh	0.0	0.0	0.0	0.0	0.0	0.0	0.0	0.0	0.0	0.0	0.0	0.0
%ile BackOfQ(50%),veh/ln	1.8	0.0	0.0	0.9	0.0	0.0	2.3	0.0	0.0	1.2	0.0	0.0
LnGrp Delay(d),s/veh	9.2	0.0	0.0	8.3	0.0	0.0	6.7	0.0	0.0	5.7	0.0	0.0
LnGrp LOS	A			A			A			A		
Approach Vol, veh/h		264			156			404			236	
Approach Delay, s/veh		9.2			8.3			6.7			5.7	
Approach LOS		A			A			A			A	
Timer	1	2	3	4	5	6	7	8				
Assigned Phs		2		4		6		8				
Phs Duration (G+Y+Rc), s		15.5		11.7		15.5		11.7				
Change Period (Y+Rc), s		4.5		4.5		4.5		4.5				
Max Green Setting (Gmax), s		30.5		20.5		30.5		20.5				
Max Q Clear Time (g_c+I1), s		7.0		5.6		4.4		3.9				
Green Ext Time (p_c), s		4.1		1.9		4.2		2.0				
Intersection Summary												
HCM 2010 Ctrl Delay				7.3								
HCM 2010 LOS				A								

Lanes, Volumes, Timings
 2: NE 117th Avenue (SR 503) & NE 99th Street

02/12/2019

												
Lane Group	EBL	EBT	EBR	WBL	WBT	WBR	NBL	NBT	NBR	SBL	SBT	SBR
Lane Configurations												
Traffic Volume (vph)	180	104	44	240	108	180	68	1276	172	148	780	80
Future Volume (vph)	180	104	44	240	108	180	68	1276	172	148	780	80
Ideal Flow (vphpl)	1900	1900	1900	1900	1900	1900	1900	1900	1900	1900	1900	1900
Storage Length (ft)	300		215	300		230	580		315	460		250
Storage Lanes	1		1	1		1	1		1	1		1
Taper Length (ft)	25			25			25			25		
Lane Util. Factor	1.00	1.00	1.00	1.00	1.00	1.00	1.00	0.95	1.00	1.00	0.95	1.00
Frt			0.850			0.850			0.850			0.850
Flt Protected	0.950			0.950			0.950			0.950		
Satd. Flow (prot)	1736	1827	1553	1787	1881	1599	1770	3539	1583	1736	3471	1553
Flt Permitted	0.687			0.430			0.325			0.083		
Satd. Flow (perm)	1255	1827	1553	809	1881	1599	605	3539	1583	152	3471	1553
Right Turn on Red			Yes			Yes			Yes			Yes
Satd. Flow (RTOR)			95			91			172			80
Link Speed (mph)		30			35			40			40	
Link Distance (ft)		952			8013			3477			3940	
Travel Time (s)		21.6			156.1			59.3			67.2	
Peak Hour Factor	1.00	1.00	1.00	1.00	1.00	1.00	1.00	1.00	1.00	1.00	1.00	1.00
Heavy Vehicles (%)	4%	4%	4%	1%	1%	1%	2%	2%	2%	4%	4%	4%
Adj. Flow (vph)	180	104	44	240	108	180	68	1276	172	148	780	80
Shared Lane Traffic (%)												
Lane Group Flow (vph)	180	104	44	240	108	180	68	1276	172	148	780	80
Enter Blocked Intersection	No	No	No	No	No	No	No	No	No	No	No	No
Lane Alignment	Left	Left	Right	Left	Left	Right	Left	Left	Right	Left	Left	Right
Median Width(ft)		12			12			12			12	
Link Offset(ft)		0			0			0			0	
Crosswalk Width(ft)		16			16			16			16	
Two way Left Turn Lane												
Headway Factor	1.00	1.00	1.00	1.00	1.00	1.00	1.00	1.00	1.00	1.00	1.00	1.00
Turning Speed (mph)	15		9	15		9	15		9	15		9
Number of Detectors	1	2	1	1	2	1	1	2	1	1	2	1
Detector Template	Left	Thru	Right	Left	Thru	Right	Left	Thru	Right	Left	Thru	Right
Leading Detector (ft)	20	100	20	20	100	20	20	100	20	20	100	20
Trailing Detector (ft)	0	0	0	0	0	0	0	0	0	0	0	0
Detector 1 Position(ft)	0	0	0	0	0	0	0	0	0	0	0	0
Detector 1 Size(ft)	20	6	20	20	6	20	20	6	20	20	6	20
Detector 1 Type	Cl+Ex	Cl+Ex	Cl+Ex	Cl+Ex	Cl+Ex	Cl+Ex	Cl+Ex	Cl+Ex	Cl+Ex	Cl+Ex	Cl+Ex	Cl+Ex
Detector 1 Channel												
Detector 1 Extend (s)	0.0	0.0	0.0	0.0	0.0	0.0	0.0	0.0	0.0	0.0	0.0	0.0
Detector 1 Queue (s)	0.0	0.0	0.0	0.0	0.0	0.0	0.0	0.0	0.0	0.0	0.0	0.0
Detector 1 Delay (s)	0.0	0.0	0.0	0.0	0.0	0.0	0.0	0.0	0.0	0.0	0.0	0.0
Detector 2 Position(ft)		94			94			94			94	
Detector 2 Size(ft)		6			6			6			6	
Detector 2 Type		Cl+Ex			Cl+Ex			Cl+Ex			Cl+Ex	
Detector 2 Channel												
Detector 2 Extend (s)		0.0			0.0			0.0			0.0	
Turn Type	pm+pt	NA	pm+ov	pm+pt	NA	pm+ov	pm+pt	NA	pm+ov	pm+pt	NA	pm+ov
Protected Phases	7	4	5	3	8	1	5	2	3	1	6	7

Lanes, Volumes, Timings
 2: NE 117th Avenue (SR 503) & NE 99th Street

02/12/2019



Lane Group	EBL	EBT	EBR	WBL	WBT	WBR	NBL	NBT	NBR	SBL	SBT	SBR
Permitted Phases	4		4	8		8	2		2	6		6
Detector Phase	7	4	5	3	8	1	5	2	3	1	6	7
Switch Phase												
Minimum Initial (s)	5.0	5.0	5.0	5.0	5.0	5.0	5.0	5.0	5.0	5.0	5.0	5.0
Minimum Split (s)	9.5	22.5	9.5	9.5	22.5	9.5	9.5	22.5	9.5	9.5	22.5	9.5
Total Split (s)	17.4	22.5	9.8	19.0	24.1	18.0	9.8	60.5	19.0	18.0	68.7	17.4
Total Split (%)	14.5%	18.8%	8.2%	15.8%	20.1%	15.0%	8.2%	50.4%	15.8%	15.0%	57.3%	14.5%
Maximum Green (s)	12.9	18.0	5.3	14.5	19.6	13.5	5.3	56.0	14.5	13.5	64.2	12.9
Yellow Time (s)	3.5	3.5	3.5	3.5	3.5	3.5	3.5	3.5	3.5	3.5	3.5	3.5
All-Red Time (s)	1.0	1.0	1.0	1.0	1.0	1.0	1.0	1.0	1.0	1.0	1.0	1.0
Lost Time Adjust (s)	0.0	0.0	0.0	0.0	0.0	0.0	0.0	0.0	0.0	0.0	0.0	0.0
Total Lost Time (s)	4.5	4.5	4.5	4.5	4.5	4.5	4.5	4.5	4.5	4.5	4.5	4.5
Lead/Lag	Lead	Lag	Lead	Lead	Lag	Lead	Lead	Lag	Lead	Lead	Lag	Lead
Lead-Lag Optimize?	Yes	Yes	Yes	Yes	Yes	Yes	Yes	Yes	Yes	Yes	Yes	Yes
Vehicle Extension (s)	3.0	3.0	3.0	3.0	3.0	3.0	3.0	3.0	3.0	3.0	3.0	3.0
Recall Mode	None	None	None	None	None	None	None	Min	None	None	Min	None
Walk Time (s)		7.0			7.0			7.0			7.0	
Flash Dont Walk (s)		11.0			11.0			11.0			11.0	
Pedestrian Calls (#/hr)		0			0			0			0	
Act Effct Green (s)	21.3	11.2	18.2	26.7	12.3	26.7	48.1	42.6	63.6	56.5	49.6	66.3
Actuated g/C Ratio	0.22	0.12	0.19	0.28	0.13	0.28	0.50	0.45	0.67	0.59	0.52	0.69
v/c Ratio	0.53	0.49	0.12	0.61	0.45	0.35	0.18	0.81	0.15	0.59	0.43	0.07
Control Delay	35.4	51.2	0.6	36.9	47.9	17.2	10.2	27.9	1.6	25.3	15.8	1.5
Queue Delay	0.0	0.0	0.0	0.0	0.0	0.0	0.0	0.0	0.0	0.0	0.0	0.0
Total Delay	35.4	51.2	0.6	36.9	47.9	17.2	10.2	27.9	1.6	25.3	15.8	1.5
LOS	D	D	A	D	D	B	B	C	A	C	B	A
Approach Delay		35.8			32.4			24.1			16.0	
Approach LOS		D			C			C			B	

Intersection Summary

Area Type: Other
 Cycle Length: 120
 Actuated Cycle Length: 95.4
 Natural Cycle: 80
 Control Type: Actuated-Uncoordinated
 Maximum v/c Ratio: 0.81
 Intersection Signal Delay: 24.2
 Intersection LOS: C
 Intersection Capacity Utilization 74.7%
 ICU Level of Service D
 Analysis Period (min) 15

Splits and Phases: 2: NE 117th Avenue (SR 503) & NE 99th Street

18 s	60.5 s	19 s	22.5 s
9.8 s	68.7 s	17.4 s	24.1 s

Queues

2: NE 117th Avenue (SR 503) & NE 99th Street

02/12/2019



























Lane Group	EBL	EBT	EBR	WBL	WBT	WBR	NBL	NBT	NBR	SBL	SBT	SBR
Lane Group Flow (vph)	180	104	44	240	108	180	68	1276	172	148	780	80
v/c Ratio	0.53	0.49	0.12	0.61	0.45	0.35	0.18	0.81	0.15	0.59	0.43	0.07
Control Delay	35.4	51.2	0.6	36.9	47.9	17.2	10.2	27.9	1.6	25.3	15.8	1.5
Queue Delay	0.0	0.0	0.0	0.0	0.0	0.0	0.0	0.0	0.0	0.0	0.0	0.0
Total Delay	35.4	51.2	0.6	36.9	47.9	17.2	10.2	27.9	1.6	25.3	15.8	1.5
Queue Length 50th (ft)	84	61	0	116	62	42	16	343	0	37	157	0
Queue Length 95th (ft)	173	130	0	226	132	111	37	502	25	111	224	15
Internal Link Dist (ft)		872			7933			3397			3860	
Turn Bay Length (ft)	300		215	300		230	580		315	460		250
Base Capacity (vph)	366	358	373	402	401	581	372	2158	1118	323	2426	1124
Starvation Cap Reductn	0	0	0	0	0	0	0	0	0	0	0	0
Spillback Cap Reductn	0	0	0	0	0	0	0	0	0	0	0	0
Storage Cap Reductn	0	0	0	0	0	0	0	0	0	0	0	0
Reduced v/c Ratio	0.49	0.29	0.12	0.60	0.27	0.31	0.18	0.59	0.15	0.46	0.32	0.07

Intersection Summary

HCM 2010 Signalized Intersection Summary
 2: NE 117th Avenue (SR 503) & NE 99th Street

02/12/2019

												
Movement	EBL	EBT	EBR	WBL	WBT	WBR	NBL	NBT	NBR	SBL	SBT	SBR
Lane Configurations												
Traffic Volume (veh/h)	180	104	44	240	108	180	68	1276	172	148	780	80
Future Volume (veh/h)	180	104	44	240	108	180	68	1276	172	148	780	80
Number	7	4	14	3	8	18	5	2	12	1	6	16
Initial Q (Qb), veh	0	0	0	0	0	0	0	0	0	0	0	0
Ped-Bike Adj(A_pbT)	1.00		1.00	1.00		1.00	1.00		1.00	1.00		1.00
Parking Bus, Adj	1.00	1.00	1.00	1.00	1.00	1.00	1.00	1.00	1.00	1.00	1.00	1.00
Adj Sat Flow, veh/h/ln	1827	1827	1827	1881	1881	1881	1863	1863	1863	1827	1827	1827
Adj Flow Rate, veh/h	180	104	44	240	108	180	68	1276	172	148	780	80
Adj No. of Lanes	1	1	1	1	1	1	1	2	1	1	2	1
Peak Hour Factor	1.00	1.00	1.00	1.00	1.00	1.00	1.00	1.00	1.00	1.00	1.00	1.00
Percent Heavy Veh, %	4	4	4	1	1	1	2	2	2	4	4	4
Cap, veh/h	359	199	238	393	256	318	396	1763	1008	263	1794	976
Arrive On Green	0.11	0.11	0.11	0.14	0.14	0.14	0.04	0.50	0.50	0.06	0.52	0.52
Sat Flow, veh/h	1740	1827	1553	1792	1881	1599	1774	3539	1583	1740	3471	1553
Grp Volume(v), veh/h	180	104	44	240	108	180	68	1276	172	148	780	80
Grp Sat Flow(s),veh/h/ln	1740	1827	1553	1792	1881	1599	1774	1770	1583	1740	1736	1553
Q Serve(g_s), s	8.5	5.1	2.3	10.9	4.9	9.6	1.7	26.6	4.2	3.8	13.2	1.9
Cycle Q Clear(g_c), s	8.5	5.1	2.3	10.9	4.9	9.6	1.7	26.6	4.2	3.8	13.2	1.9
Prop In Lane	1.00		1.00	1.00		1.00	1.00		1.00	1.00		1.00
Lane Grp Cap(c), veh/h	359	199	238	393	256	318	396	1763	1008	263	1794	976
V/C Ratio(X)	0.50	0.52	0.19	0.61	0.42	0.57	0.17	0.72	0.17	0.56	0.43	0.08
Avail Cap(c_a), veh/h	404	350	366	422	392	434	418	2109	1163	404	2371	1234
HCM Platoon Ratio	1.00	1.00	1.00	1.00	1.00	1.00	1.00	1.00	1.00	1.00	1.00	1.00
Upstream Filter(I)	1.00	1.00	1.00	1.00	1.00	1.00	1.00	1.00	1.00	1.00	1.00	1.00
Uniform Delay (d), s/veh	31.9	39.6	34.7	30.9	37.2	34.0	11.0	18.5	7.0	16.3	14.1	6.8
Incr Delay (d2), s/veh	1.1	2.1	0.4	2.3	1.1	1.6	0.2	1.0	0.1	1.9	0.2	0.0
Initial Q Delay(d3),s/veh	0.0	0.0	0.0	0.0	0.0	0.0	0.0	0.0	0.0	0.0	0.0	0.0
%ile BackOfQ(50%),veh/ln	4.1	2.7	1.0	5.6	2.7	4.4	0.9	13.2	1.8	1.9	6.3	0.8
LnGrp Delay(d),s/veh	33.0	41.7	35.1	33.2	38.3	35.6	11.2	19.5	7.0	18.2	14.3	6.9
LnGrp LOS	C	D	D	C	D	D	B	B	A	B	B	A
Approach Vol, veh/h		328			528			1516			1008	
Approach Delay, s/veh		36.0			35.0			17.7			14.3	
Approach LOS		D			D			B			B	
Timer	1	2	3	4	5	6	7	8				
Assigned Phs	1	2	3	4	5	6	7	8				
Phs Duration (G+Y+Rc), s	10.4	51.3	17.5	14.7	8.7	53.1	15.0	17.3				
Change Period (Y+Rc), s	4.5	4.5	4.5	4.5	4.5	4.5	4.5	4.5				
Max Green Setting (Gmax), s	13.5	56.0	14.5	18.0	5.3	64.2	12.9	19.6				
Max Q Clear Time (g_c+I1), s	5.8	28.6	12.9	7.1	3.7	15.2	10.5	11.6				
Green Ext Time (p_c), s	0.2	18.2	0.1	1.4	0.0	25.6	0.1	1.2				
Intersection Summary												
HCM 2010 Ctrl Delay			21.2									
HCM 2010 LOS			C									

Lanes, Volumes, Timings
 3: NE 152nd Avenue & NE Padden Parkway

02/13/2019



Lane Group	EBL	EBT	EBR	WBL	WBT	WBR	NBL	NBT	NBR	SBL	SBT	SBR
Lane Configurations												
Traffic Volume (vph)	4	536	236	248	580	128	68	312	4	132	280	116
Future Volume (vph)	4	536	236	248	580	128	68	312	4	132	280	116
Ideal Flow (vphpl)	1900	1900	1900	1900	1900	1900	1900	1900	1900	1900	1900	1900
Storage Length (ft)	330		0	215		125	205		0	315		100
Storage Lanes	1		1	1		1	1		0	1		1
Taper Length (ft)	25			25			25			25		
Lane Util. Factor	1.00	1.00	1.00	1.00	1.00	1.00	1.00	1.00	1.00	1.00	1.00	1.00
Frt			0.850			0.850		0.998				0.850
Flt Protected	0.950			0.950			0.950			0.950		
Satd. Flow (prot)	1787	1881	1599	1787	1881	1599	1805	1896	0	1770	1863	1583
Flt Permitted	0.950			0.950			0.353			0.287		
Satd. Flow (perm)	1787	1881	1599	1787	1881	1599	671	1896	0	535	1863	1583
Right Turn on Red			Yes			Yes			Yes			Yes
Satd. Flow (RTOR)			204			121		1				127
Link Speed (mph)		50			50			35				35
Link Distance (ft)		1502			1580			896				3406
Travel Time (s)		20.5			21.5			17.5				66.4
Peak Hour Factor	1.00	1.00	1.00	1.00	1.00	1.00	1.00	1.00	1.00	1.00	1.00	1.00
Heavy Vehicles (%)	1%	1%	1%	1%	1%	1%	0%	0%	0%	2%	2%	2%
Adj. Flow (vph)	4	536	236	248	580	128	68	312	4	132	280	116
Shared Lane Traffic (%)												
Lane Group Flow (vph)	4	536	236	248	580	128	68	316	0	132	280	116
Enter Blocked Intersection	No	No	No	No	No	No	No	No	No	No	No	No
Lane Alignment	Left	Left	Right	Left	Left	Right	Left	Left	Right	Left	Left	Right
Median Width(ft)		12			12			12				12
Link Offset(ft)		0			0			0				0
Crosswalk Width(ft)		16			16			16				16
Two way Left Turn Lane												
Headway Factor	1.00	1.00	1.00	1.00	1.00	1.00	1.00	1.00	1.00	1.00	1.00	1.00
Turning Speed (mph)	15		9	15		9	15		9	15		9
Turn Type	Prot	NA	pm+ov	Prot	NA	pm+ov	pm+pt	NA		pm+pt	NA	pm+ov
Protected Phases	7	4	5	3	8	1	5	2		1	6	7
Permitted Phases			4			8	2			6		6
Minimum Split (s)	9.5	22.5	9.5	9.5	22.5	9.5	9.5	22.5		9.5	22.5	9.5
Total Split (s)	9.6	34.6	9.8	20.4	45.4	9.8	9.8	25.2		9.8	25.2	9.6
Total Split (%)	10.7%	38.4%	10.9%	22.7%	50.4%	10.9%	10.9%	28.0%		10.9%	28.0%	10.7%
Maximum Green (s)	5.1	30.1	5.3	15.9	40.9	5.3	5.3	20.7		5.3	20.7	5.1
Yellow Time (s)	3.5	3.5	3.5	3.5	3.5	3.5	3.5	3.5		3.5	3.5	3.5
All-Red Time (s)	1.0	1.0	1.0	1.0	1.0	1.0	1.0	1.0		1.0	1.0	1.0
Lost Time Adjust (s)	0.0	0.0	0.0	0.0	0.0	0.0	0.0	0.0		0.0	0.0	0.0
Total Lost Time (s)	4.5	4.5	4.5	4.5	4.5	4.5	4.5	4.5		4.5	4.5	4.5
Lead/Lag	Lead	Lag	Lead	Lead	Lag	Lead	Lead	Lag		Lead	Lag	Lead
Lead-Lag Optimize?	Yes	Yes	Yes	Yes	Yes	Yes	Yes	Yes		Yes	Yes	Yes
Walk Time (s)		7.0			7.0			7.0				7.0
Flash Dont Walk (s)		11.0			11.0			11.0				11.0
Pedestrian Calls (#/hr)		0			0			0				0
Act Effct Green (s)	5.1	30.1	39.9	15.9	40.9	50.7	26.0	20.7		26.0	20.7	30.3
Actuated g/C Ratio	0.06	0.33	0.44	0.18	0.45	0.56	0.29	0.23		0.29	0.23	0.34

Lanes, Volumes, Timings
 3: NE 152nd Avenue & NE Padden Parkway

02/13/2019



Lane Group	EBL	EBT	EBR	WBL	WBT	WBR	NBL	NBT	NBR	SBL	SBT	SBR
v/c Ratio	0.04	0.85	0.29	0.79	0.68	0.13	0.26	0.72		0.58	0.65	0.19
Control Delay	41.0	42.8	4.4	54.7	24.4	2.4	23.4	42.9		33.8	39.7	4.3
Queue Delay	0.0	0.0	0.0	0.0	0.0	0.0	0.0	0.0		0.0	0.0	0.0
Total Delay	41.0	42.8	4.4	54.7	24.4	2.4	23.4	42.9		33.8	39.7	4.3
LOS	D	D	A	D	C	A	C	D		C	D	A
Approach Delay		31.1			29.3			39.4			30.4	
Approach LOS		C			C			D			C	

Intersection Summary

Area Type:	Other
Cycle Length:	90
Actuated Cycle Length:	90
Offset:	0 (0%), Referenced to phase 2:NBTL and 6:SBTL, Start of Green
Natural Cycle:	80
Control Type:	Pretimed
Maximum v/c Ratio:	0.85
Intersection Signal Delay:	31.5
Intersection LOS:	C
Intersection Capacity Utilization	80.9%
ICU Level of Service	D
Analysis Period (min)	15

Splits and Phases: 3: NE 152nd Avenue & NE Padden Parkway

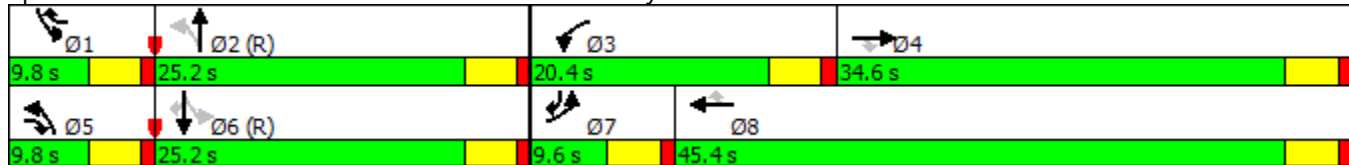

Queues

3: NE 152nd Avenue & NE Padden Parkway

02/13/2019

























Lane Group	EBL	EBT	EBR	WBL	WBT	WBR	NBL	NBT	SBL	SBT	SBR
Lane Group Flow (vph)	4	536	236	248	580	128	68	316	132	280	116
v/c Ratio	0.04	0.85	0.29	0.79	0.68	0.13	0.26	0.72	0.58	0.65	0.19
Control Delay	41.0	42.8	4.4	54.7	24.4	2.4	23.4	42.9	33.8	39.7	4.3
Queue Delay	0.0	0.0	0.0	0.0	0.0	0.0	0.0	0.0	0.0	0.0	0.0
Total Delay	41.0	42.8	4.4	54.7	24.4	2.4	23.4	42.9	33.8	39.7	4.3
Queue Length 50th (ft)	2	280	10	136	251	2	26	166	53	145	0
Queue Length 95th (ft)	13	#460	52	#255	372	25	56	#278	97	230	31
Internal Link Dist (ft)		1422			1500			816		3326	
Turn Bay Length (ft)	330			215		125	205		315		100
Base Capacity (vph)	101	629	822	315	854	953	260	436	227	428	617
Starvation Cap Reductn	0	0	0	0	0	0	0	0	0	0	0
Spillback Cap Reductn	0	0	0	0	0	0	0	0	0	0	0
Storage Cap Reductn	0	0	0	0	0	0	0	0	0	0	0
Reduced v/c Ratio	0.04	0.85	0.29	0.79	0.68	0.13	0.26	0.72	0.58	0.65	0.19

Intersection Summary

95th percentile volume exceeds capacity, queue may be longer.
 Queue shown is maximum after two cycles.

HCM 2010 Signalized Intersection Summary
 3: NE 152nd Avenue & NE Padden Parkway

02/13/2019

												
Movement	EBL	EBT	EBR	WBL	WBT	WBR	NBL	NBT	NBR	SBL	SBT	SBR
Lane Configurations												
Traffic Volume (veh/h)	4	536	236	248	580	128	68	312	4	132	280	116
Future Volume (veh/h)	4	536	236	248	580	128	68	312	4	132	280	116
Number	7	4	14	3	8	18	5	2	12	1	6	16
Initial Q (Qb), veh	0	0	0	0	0	0	0	0	0	0	0	0
Ped-Bike Adj(A_pbT)	1.00		1.00	1.00		1.00	1.00		1.00	1.00		1.00
Parking Bus, Adj	1.00	1.00	1.00	1.00	1.00	1.00	1.00	1.00	1.00	1.00	1.00	1.00
Adj Sat Flow, veh/h/ln	1881	1881	1881	1881	1881	1881	1900	1900	1900	1863	1863	1863
Adj Flow Rate, veh/h	4	536	236	248	580	128	68	312	4	132	280	116
Adj No. of Lanes	1	1	1	1	1	1	1	1	0	1	1	1
Peak Hour Factor	1.00	1.00	1.00	1.00	1.00	1.00	1.00	1.00	1.00	1.00	1.00	1.00
Percent Heavy Veh, %	1	1	1	1	1	1	0	0	0	2	2	2
Cap, veh/h	102	629	629	317	855	821	281	431	6	265	428	454
Arrive On Green	0.06	0.33	0.33	0.18	0.45	0.45	0.06	0.23	0.23	0.06	0.23	0.23
Sat Flow, veh/h	1792	1881	1599	1792	1881	1599	1810	1872	24	1774	1863	1583
Grp Volume(v), veh/h	4	536	236	248	580	128	68	0	316	132	280	116
Grp Sat Flow(s),veh/h/ln	1792	1881	1599	1792	1881	1599	1810	0	1896	1774	1863	1583
Q Serve(g_s), s	0.2	23.9	9.5	11.9	21.9	3.8	2.5	0.0	13.9	5.1	12.3	5.1
Cycle Q Clear(g_c), s	0.2	23.9	9.5	11.9	21.9	3.8	2.5	0.0	13.9	5.1	12.3	5.1
Prop In Lane	1.00		1.00	1.00		1.00	1.00		0.01	1.00		1.00
Lane Grp Cap(c), veh/h	102	629	629	317	855	821	281	0	436	265	428	454
V/C Ratio(X)	0.04	0.85	0.38	0.78	0.68	0.16	0.24	0.00	0.72	0.50	0.65	0.26
Avail Cap(c_a), veh/h	102	629	629	317	855	821	281	0	436	265	428	454
HCM Platoon Ratio	1.00	1.00	1.00	1.00	1.00	1.00	1.00	1.00	1.00	1.00	1.00	1.00
Upstream Filter(I)	1.00	1.00	1.00	1.00	1.00	1.00	1.00	0.00	1.00	1.00	1.00	1.00
Uniform Delay (d), s/veh	40.1	27.9	19.4	35.4	19.4	11.6	24.5	0.0	32.0	25.8	31.4	24.7
Incr Delay (d2), s/veh	0.7	13.7	1.7	17.5	4.3	0.4	2.0	0.0	10.1	6.6	7.6	1.4
Initial Q Delay(d3),s/veh	0.0	0.0	0.0	0.0	0.0	0.0	0.0	0.0	0.0	0.0	0.0	0.0
%ile BackOfQ(50%),veh/ln	0.1	14.7	4.5	7.4	12.3	1.8	1.4	0.0	8.4	3.0	7.2	2.4
LnGrp Delay(d),s/veh	40.9	41.5	21.1	52.9	23.7	12.0	26.6	0.0	42.1	32.4	39.0	26.1
LnGrp LOS	D	D	C	D	C	B	C		D	C	D	C
Approach Vol, veh/h		776			956			384			528	
Approach Delay, s/veh		35.3			29.7			39.3			34.5	
Approach LOS		D			C			D			C	
Timer	1	2	3	4	5	6	7	8				
Assigned Phs	1	2	3	4	5	6	7	8				
Phs Duration (G+Y+Rc), s	9.8	25.2	20.4	34.6	9.8	25.2	9.6	45.4				
Change Period (Y+Rc), s	4.5	4.5	4.5	4.5	4.5	4.5	4.5	4.5				
Max Green Setting (Gmax), s	5.3	20.7	15.9	30.1	5.3	20.7	5.1	40.9				
Max Q Clear Time (g_c+I1), s	7.1	15.9	13.9	25.9	4.5	14.3	2.2	23.9				
Green Ext Time (p_c), s	0.0	1.7	0.1	2.7	0.0	2.1	0.0	7.3				
Intersection Summary												
HCM 2010 Ctrl Delay			33.7									
HCM 2010 LOS			C									

Lanes, Volumes, Timings
 4: NE 152nd Avenue & NE 99th Street

02/12/2019



Lane Group	EBL	EBT	EBR	WBL	WBT	WBR	NBL	NBT	NBR	SBL	SBT	SBR
Lane Configurations		↕	↗		↕			↕			↕	
Traffic Volume (vph)	84	84	76	24	72	28	112	368	36	44	272	52
Future Volume (vph)	84	84	76	24	72	28	112	368	36	44	272	52
Ideal Flow (vphpl)	1900	1900	1900	1900	1900	1900	1900	1900	1900	1900	1900	1900
Storage Length (ft)	0		140	0		0	0		0	0		0
Storage Lanes	0		1	0		0	0		0	0		0
Taper Length (ft)	25			25			25			25		
Lane Util. Factor	1.00	1.00	1.00	1.00	1.00	1.00	1.00	1.00	1.00	1.00	1.00	1.00
Frt			0.850		0.970			0.991			0.981	
Flt Protected		0.976			0.990			0.989			0.994	
Satd. Flow (prot)	0	1800	1568	0	1825	0	0	1826	0	0	1853	0
Flt Permitted		0.976			0.990			0.989			0.994	
Satd. Flow (perm)	0	1800	1568	0	1825	0	0	1826	0	0	1853	0
Link Speed (mph)		35			35			35			35	
Link Distance (ft)		8013			3202			3406			4539	
Travel Time (s)		156.1			62.4			66.4			88.4	
Peak Hour Factor	1.00	1.00	1.00	1.00	1.00	1.00	1.00	1.00	1.00	1.00	1.00	1.00
Heavy Vehicles (%)	3%	3%	3%	0%	0%	0%	2%	2%	2%	0%	0%	0%
Adj. Flow (vph)	84	84	76	24	72	28	112	368	36	44	272	52
Shared Lane Traffic (%)												
Lane Group Flow (vph)	0	168	76	0	124	0	0	516	0	0	368	0
Enter Blocked Intersection	No	No	No	No	No	No	No	No	No	No	No	No
Lane Alignment	Left	Left	Right	Left	Left	Right	Left	Left	Right	Left	Left	Right
Median Width(ft)		12			12			12			12	
Link Offset(ft)		0			0			0			0	
Crosswalk Width(ft)		16			16			16			16	
Two way Left Turn Lane												
Headway Factor	1.00	1.00	1.00	1.00	1.00	1.00	1.00	1.00	1.00	1.00	1.00	1.00
Turning Speed (mph)	15		9	15		9	15		9	15		9
Sign Control		Stop			Stop			Stop			Stop	

Intersection Summary

Area Type:	Other
Control Type:	Unsignalized
Intersection Capacity Utilization	68.9%
ICU Level of Service	C
Analysis Period (min)	15

Intersection	
Intersection Delay, s/veh	23.8
Intersection LOS	C

Movement	EBL	EBT	EBR	WBL	WBT	WBR	NBL	NBT	NBR	SBL	SBT	SBR
Lane Configurations		↔	↔		↔			↔			↔	
Traffic Vol, veh/h	84	84	76	24	72	28	112	368	36	44	272	52
Future Vol, veh/h	84	84	76	24	72	28	112	368	36	44	272	52
Peak Hour Factor	1.00	1.00	1.00	1.00	1.00	1.00	1.00	1.00	1.00	1.00	1.00	1.00
Heavy Vehicles, %	3	3	3	0	0	0	2	2	2	0	0	0
Mvmt Flow	84	84	76	24	72	28	112	368	36	44	272	52
Number of Lanes	0	1	1	0	1	0	0	1	0	0	1	0

Approach	EB	WB	NB	SB
Opposing Approach	WB	EB	SB	NB
Opposing Lanes	1	2	1	1
Conflicting Approach Left	SB	NB	EB	WB
Conflicting Lanes Left	1	1	2	1
Conflicting Approach Right	NB	SB	WB	EB
Conflicting Lanes Right	1	1	1	2
HCM Control Delay	13.5	12.8	34.6	19.1
HCM LOS	B	B	D	C

Lane	NBLn1	EBLn1	EBLn2	WBLn1	SBLn1
Vol Left, %	22%	50%	0%	19%	12%
Vol Thru, %	71%	50%	0%	58%	74%
Vol Right, %	7%	0%	100%	23%	14%
Sign Control	Stop	Stop	Stop	Stop	Stop
Traffic Vol by Lane	516	168	76	124	368
LT Vol	112	84	0	24	44
Through Vol	368	84	0	72	272
RT Vol	36	0	76	28	52
Lane Flow Rate	516	168	76	124	368
Geometry Grp	2	7	7	5	2
Degree of Util (X)	0.856	0.361	0.143	0.251	0.629
Departure Headway (Hd)	5.969	7.732	6.755	7.287	6.151
Convergence, Y/N	Yes	Yes	Yes	Yes	Yes
Cap	604	464	529	491	585
Service Time	4.017	5.494	4.517	5.364	4.205
HCM Lane V/C Ratio	0.854	0.362	0.144	0.253	0.629
HCM Control Delay	34.6	14.8	10.7	12.8	19.1
HCM Lane LOS	D	B	B	B	C
HCM 95th-tile Q	9.5	1.6	0.5	1	4.4

APPENDIX C
ACCIDENT DATA

OFFICER REPORTED CRASHES THAT OCCURRED AT THE FOLLOWING INTERSECTIONS IN CLARK COUNTY

- 152nd Ave - north leg (Co Rd #51390, MP 0.000 - 0.020) @ 119th St (Co Rd #94100, MP 6.090 - 6.130)
- 152nd Ave - south leg (Co Rd #24190, MP 0.000 - 0.020) @ 119th St (Co Rd #94100, MP 6.090 - 6.130)
- 152nd Ave (Co Rd #24190, MP 0.980 - 1.020) @ 99th St (Co Rd #23940, MP 0.980 - 1.020)
- SR 500 (aka Padden Pkwy, MP 8.678 - 8.768) @ 152nd Ave (Co Rd, MP 24190, MP 1.730 - 1.770)
- SR 503 (aka 117th Ave, MP 1.71 - 1.84) @ 99th St (Co Rd #23940, 2.740 - 2.780)

01/01/2014 - available 2018

Under 23 U.S. Code § 409 and 23 U.S. Code § 148, safety data, reports, surveys, schedules, lists compiled or collected for the purpose of identifying, evaluating, or planning the safety enhancement of potential crash sites, hazardous roadway conditions, or railway-highway crossings are not subject to discovery or admitted into evidence in a Federal or State court proceeding or considered for other purposes in any action for damages arising from any occurrence at a location mentioned or addressed in such reports, surveys, schedules, lists, or data.

JURISDICTION	COUNTY	CITY	PRIMARY TRAFFICWAY	MILEPOST	A/B	BLOCK NUMBER	INTERSECTING TRAFFICWAY	CO ONLY INTERSECTING COUNTY ROAD MILEPOST	DIST FROM REF POINT	MI or FT	COMP DIR FROM REF POINT	REFERENCE POINT NAME	SR ONLY HISTORY / SUSPENSE IND	REPORT NUMBER	DATE	TIME	MOST SEVERE INJURY TYPE	# FATALS	# INJURIES	# PEDESTRIANS	VEHICLE 1 TYPE	VEHICLE 2 TYPE	JUNCTION RELATIONSHIP	WEATHER	ROADWAY SURFACE CONDITION	LIGHTING CONDITION	FIRST COLLISION TYPE / OBJECT STRUCK	VEHICLE 1 ACTION	VEHICLE 2 ACTION	VEHICLE 1 COMPASS DIRECTION FROM	VEHICLE 1 COMPASS DIRECTION TO	VEHICLE 2 COMPASS DIRECTION FROM	VEHICLE 2 COMPASS DIRECTION TO	MV DRIVER CONTRIBUTING CIRCUMSTANCE 1 (UNIT 1)	MV DRIVER CONTRIBUTING CIRCUMSTANCE 2 (UNIT 1)	MV DRIVER CONTRIBUTING CIRCUMSTANCE 3 (UNIT 1)	MV DRIVER CONTRIBUTING CIRCUMSTANCE 1 (UNIT 2)	MV DRIVER CONTRIBUTING CIRCUMSTANCE 2 (UNIT 2)	PEDESTRIAN CONTRIBUTING CIRCUMSTANCE 1 (UNIT 2)	PEDESTRIAN CONTRIBUTING CIRCUMSTANCE 2 (UNIT 2)	FIRST IMPACT LOCATION (City, County & Misc Trafficways - 2010 forward)	WA STATE PLANE SOUTH - X 2010 - FORWARD	WA STATE PLANE SOUTH - Y 2010 - FORWARD									
County Road	Clark		23940	1.000			24190	1.000					No	3169625	10/23/2015	19:06	No Apparent Injury	0	0	0	0	Passenger Car	Pickup,Panel Truck or Vanette under 10,000 lb	At Intersection and Related	Clear or Partly Cloudy	Dry	Dark-Street Lights On	Entering at angle	Going Straight Ahead	Going Straight Ahead	West	East	North	South	Inattention	Did Not Grant RW to Vehicle									Lane of Primary Trafficway	1125155.9	138052.81					
County Road	Clark		23940	1.000			24190	1.000					No	E412094	03/30/2015	13:37	No Apparent Injury	0	0	0	0	Pickup,Panel Truck or Vanette under 10,000 lb	Passenger Car	At Intersection and Related	Clear or Partly Cloudy	Dry	Daylight	Entering at angle	Making Left Turn	Going Straight Ahead	South	West	West	East	Did Not Grant RW to Vehicle													Lane of Primary Trafficway	1125166.662	138053.29		
County Road	Clark		23940	1.000			24190	1.000					No	E476910	10/27/2015	19:05	No Apparent Injury	0	0	0	0	Passenger Car	Passenger Car	At Intersection and Related	Clear or Partly Cloudy	Dry	Dark-Street Lights On	Entering at angle	Going Straight Ahead	Starting in Traffic Lane	West	East	South	North	Other													Lane of Primary Trafficway	1125155.9	138052.81		
County Road	Clark		23940	1.000			24190	1.000					No	E697313	07/06/2017	18:43	No Apparent Injury	0	0	0	0	Passenger Car	Pickup,Panel Truck or Vanette under 10,000 lb	At Intersection and Related	Clear or Partly Cloudy	Dry	Daylight	Entering at angle	Going Straight Ahead	Making Left Turn	North	South	West	North	Inattention														Lane of Primary Trafficway	1125155.91	138052.81	
County Road	Clark		23940	2.755									No	E645815	02/23/2017	08:38	No Apparent Injury	0	0	0	0	Passenger Car	Pickup,Panel Truck or Vanette under 10,000 lb	Not at Intersection and Not Related	Fog or Smog or Smoke	Dry	Daylight	From same direction - both going straight - both moving - rear-end	Going Straight Ahead	Going Straight Ahead	West	East	West	East	Unknown Driver Distraction	Follow Too Closely													Lane of Primary Trafficway	1116350.48	138138.13	
County Road	Clark		23940	2.760									No	E853510	10/20/2018	16:14	Possible Injury	1	0	1	1	Pickup,Panel Truck or Vanette under 10,000 lb		At Intersection and Related	Clear or Partly Cloudy	Dry	Daylight	Vehicle turning right hits pedestrian	Making Right Turn				South	East					Fail to Yield Row to Pedestrian	Inattention									None	Intersecting Trafficway	1115855.19	138137.02
County Road	Clark		24190	0.000			94100	6.110					No	E371113	10/29/2014	17:59	Suspected Minor Injury	3	0	0	0	Passenger Car	Pickup,Panel Truck or Vanette under 10,000 lb	At Intersection and Related	Clear or Partly Cloudy	Dry	Dusk	Entering at angle	Going Straight Ahead	Going Straight Ahead	South	North	West	East	Disregard Stop and Go Light													Lane of Primary Trafficway	1125324.99	143328.91		
County Road	Clark		24190	0.000			94100	6.110					No	E436026	06/17/2015	15:48	Suspected Minor Injury	1	0	0	0	Passenger Car	Pickup,Panel Truck or Vanette under 10,000 lb	At Intersection and Related	Clear or Partly Cloudy	Dry	Daylight	From opposite direction - one left turn - one straight	Making Left Turn	Going Straight Ahead	South	West	North	South	Did Not Grant RW to Vehicle														Lane of Primary Trafficway	1125323.55	143329.82	
County Road	Clark		24190	0.000			94100	6.110					No	E662069	04/04/2017	15:50	No Apparent Injury	0	0	0	0	Pickup,Panel Truck or Vanette under 10,000 lb	Passenger Car	At Intersection and Related	Overcast	Wet	Daylight	From opposite direction - one left turn - one straight	Making Left Turn	Going Straight Ahead	South	West	North	South	Did Not Grant RW to Vehicle														Lane of Primary Trafficway	1125323.56	143329.83	
County Road	Clark		24190	0.000			94100	6.110					No	E66626	04/30/2017	10:41	Suspected Minor Injury	2	0	0	0	Pickup,Panel Truck or Vanette under 10,000 lb	Pickup,Panel Truck or Vanette under 10,000 lb	At Intersection and Related	Clear or Partly Cloudy	Dry	Daylight	Entering at angle	Going Straight Ahead	Starting in Traffic Lane	South	North	East	West	None													Lane of Primary Trafficway	1125323.56	143329.83		
County Road	Clark		24190	0.000			94100	6.110					No	E671303	05/11/2017	18:39	No Apparent Injury	0	0	0	0	Passenger Car	Passenger Car	At Intersection and Related	Clear or Partly Cloudy	Dry	Daylight	From opposite direction - one left turn - one straight	Making Left Turn	Going Straight Ahead	South	West	North	South	Improper Turn	Did Not Grant RW to Vehicle													Lane of Primary Trafficway	1125323.56	143329.83	
County Road	Clark		24190	1.000			23940	1.000					No	E456458	08/29/2015	17:59	No Apparent Injury	0	0	3	0	Passenger Car	Passenger Car	At Intersection and Related	Clear or Partly Cloudy	Wet	Daylight	Entering at angle	Going Straight Ahead	Going Straight Ahead	South	North	East	West	Disregard Stop Sign - Flashing Red													Lane of Primary Trafficway	1125155.9	138052.81		
County Road	Clark		24190	1.000			23940	1.000					No	E665534	04/23/2017	18:34	No Apparent Injury	0	0	0	0	Passenger Car	Passenger Car	At Intersection and Related	Overcast	Wet	Daylight	From same direction - both going straight - one stopped - rear-end	Going Straight Ahead	Stopped at Signal or Stop Sign	South	North	Vehicle Stopped	Vehicle Stopped	Inattention	Follow Too Closely														Lane of Primary Trafficway	1125155.91	138052.81
County Road	Clark		24190	1.000			23940	1.000					No	E692925	07/17/2017	14:00	No Apparent Injury	0	0	3	0	Passenger Car	Passenger Car	At Intersection and Related	Clear or Partly Cloudy	Dry	Daylight	Entering at angle	Going Straight Ahead	Going Straight Ahead	East	West	West	North	None													Lane of Primary Trafficway	1125155.91	138052.81		
County Road	Clark		24190	1.000			23940	1.000					No	E817559	07/13/2018	18:52	Possible Injury	2	0	2	0	Passenger Car	Passenger Car	At Intersection and Related	Clear or Partly Cloudy	Dry	Daylight	Entering at angle	Going Straight Ahead	Starting in Traffic Lane	West	East	North	South	Under Influence of Alcohol	Disregard Stop Sign - Flashing Red	Exceeding Stated Speed Limit												Lane of Primary Trafficway	1125155.91	138052.81	
County Road	Clark		24190	1.000			23940	1.000					No	E848545	10/11/2018	05:32	No Apparent Injury	0	0	0	0	Passenger Car	Pickup,Panel Truck or Vanette under 10,000 lb	At Intersection and Related	Clear or Partly Cloudy	Dry	Dark-No Street Lights	Entering at angle	Starting in Traffic Lane	Starting in Traffic Lane	North	South	West	East	Unknown Driver Distraction													Lane of Primary Trafficway	1125155.91	138052.81		
County Road	Clark		51390	0.000			94100	6.110					No	E534005	04/12/2016	15:15	No Apparent Injury	0	0	0	0	Pickup,Panel Truck or Vanette under 10,000 lb	Passenger Car	At Intersection and Related	Clear or Partly Cloudy	Dry	Daylight	From opposite direction - one left turn - one straight	Making Left Turn	Going Straight Ahead	North	East	South	North	Did Not Grant RW to Vehicle													Lane of Primary Trafficway	1125323.55	143329.82		
County Road	Clark		51390	0.000			94100	6.110					No	E741248	11/22/2017	18:10	Died in Hospital	0	2	2	0	Passenger Car	Passenger Car	At Intersection and Related	Overcast	Wet	Dark-Street Lights On	From opposite direction - one left turn - one straight	Making Left Turn	Going Straight Ahead	North	East	South	North	Did Not Grant RW to Vehicle													Lane of Primary Trafficway	1125323.56	143329.83		
County Road	Clark		51390	0.000			94100	6.110					No	E757934	01/12/2018	17:54	Possible Injury	1	0	2	0	Passenger Car	Pickup,Panel Truck or Vanette under 10,000 lb	At Intersection and Related	Overcast	Wet	Dark-Street Lights On	From opposite direction - one left turn - one straight	Making Left Turn	Going Straight Ahead	South	West	North	South	Inattention	Did Not Grant RW to Vehicle													Lane of Primary Trafficway	1125323.56	143329.83	
County Road	Clark		51390	0.000			94100	6.110					No	E807444	06/11/2018	15:07	Possible Injury	1	0	2	0	Pickup,Panel Truck or Vanette under 10,000 lb	Pickup,Panel Truck or Vanette under 10,000 lb	At Intersection and Related	Clear or Partly Cloudy	Dry	Daylight	From opposite direction - one left turn - one straight	Making Left Turn	Going Straight Ahead	South	West	North	South	Improper Turn	Inattention													Lane of Primary Trafficway	1125323.56	143329.83	
County Road	Clark		51390	0.000			94100	6.110					No	E817556	07/11/2018	23:45	No Apparent Injury	0	0	2	0	Passenger Car	Passenger Car	At Intersection and Related	Clear or Partly Cloudy	Dry	Dark-No Street Lights	Entering at angle	Going Straight Ahead	Going Straight Ahead	North	South	West	East	Disregard Stop and Go Light													Lane of Primary Trafficway	1125323.56	143329.83		

OFFICER REPORTED CRASHES THAT OCCURRED AT THE FOLLOWING INTERSECTIONS IN CLARK COUNTY

- 152nd Ave - north leg (Co Rd #51390, MP 0.000 - 0.020) @ 119th St (Co Rd #94100, MP 6.090 - 6.130)
- 152nd Ave - south leg (Co Rd #24190, MP 0.000 - 0.020) @ 119th St (Co Rd #94100, MP 6.090 - 6.130)
- 152nd Ave (Co Rd #24190, MP 0.980 - 1.020) @ 99th St (Co Rd #23940, MP 0.980 - 1.020)
- SR 500 (aka Padden Pkwy, MP 8.678 - 8.768) @ 152nd Ave (Co Rd, MP 24190, MP 1.730 - 1.770)
- SR 503 (aka 117th Ave, MP 1.71 - 1.84) @ 99th St (Co Rd #23940, 2.740 - 2.780)

01/01/2014 - available 2018

Under 23 U.S. Code § 409 and 23 U.S. Code § 148, safety data, reports, surveys, schedules, lists compiled or collected for the purpose of identifying, evaluating, or planning the safety enhancement of potential crash sites, hazardous roadway conditions, or railway-highway crossings are not subject to discovery or admitted into evidence in a Federal or State court proceeding or considered for other purposes in any action for damages arising from any occurrence at a location mentioned or addressed in such reports, surveys, schedules, lists, or data.

JURISDICTION	COUNTY	CITY	PRIMARY TRAFFICWAY	MILEPOST	A/B	BLOCK NUMBER	INTERSECTING TRAFFICWAY	CO ONLY INTERSECTING COUNTY ROAD MILEPOST	DIST FROM REF POINT	MI or FT	COMP DIR FROM REF POINT	REFERENCE POINT NAME	SR ONLY HISTORY / SUSPENSE IND	REPORT NUMBER	DATE	TIME	MOST SEVERE INJURY TYPE	# FATALS	# PERSONS INJURED	# PROPERTY DAMAGE	VEHICLE 1 TYPE	VEHICLE 2 TYPE	JUNCTION RELATIONSHIP	WEATHER	ROADWAY SURFACE CONDITION	LIGHTING CONDITION	FIRST COLLISION TYPE / OBJECT STRUCK	VEHICLE 1 ACTION	VEHICLE 2 ACTION	VEHICLE 1 COMPASS DIRECTION FROM	VEHICLE 1 COMPASS DIRECTION TO	VEHICLE 2 COMPASS DIRECTION FROM	VEHICLE 2 COMPASS DIRECTION TO	MV DRIVER CONTRIBUTING CIRCUMSTANCE 1 (UNIT 1)	MV DRIVER CONTRIBUTING CIRCUMSTANCE 2 (UNIT 1)	MV DRIVER CONTRIBUTING CIRCUMSTANCE 3 (UNIT 1)	MV DRIVER CONTRIBUTING CIRCUMSTANCE 1 (UNIT 2)	MV DRIVER CONTRIBUTING CIRCUMSTANCE 2 (UNIT 2)	PEDESTRIAN CONTRIBUTING CIRCUMSTANCE 1 (UNIT 2)	PEDESTRIAN CONTRIBUTING CIRCUMSTANCE 2 (UNIT 2)	FIRST IMPACT LOCATION (City, County & Misc Trafficways - 2010 forward)	WA STATE PLANE SOUTH - Y 2010 - FORWARD	WA STATE PLANE SOUTH - Y 2010 - FORWARD								
County Road	Clark		94100	6.100									No	E573030	07/16/2016	22:17	Possible Injury	1	0	0	0	Passenger Car	Passenger Car	At Intersection and Related	Clear or Partly Cloudy	Dry	Dark-Street Lights	Entering at angle	Making Left Turn	Slowing	South	West	Vehicle Stopped	East	Exceeding Reas. Safe Speed							Intersecting Trafficway	1125323.55	143329.82							
County Road	Clark		94100	6.110			51390	0.000					No	E346759	07/31/2014	17:56	No Apparent Injury	0	0	0	0	Pickup,Panel Truck or Vanette under 10,000 lb	Passenger Car	At Intersection and Related	Clear or Partly Cloudy	Dry	Daylight	From opposite direction - one left turn - one straight	Making Left Turn	Going Straight Ahead	South	West	North	South	Did Not Grant RW to Vehicle							Inattention					Lane of Primary Trafficway	1125323.57	143329.82		
County Road	Clark		94100	6.110			24190	0.000					No	E340300	07/01/2014	06:49	No Apparent Injury	0	0	0	0	Passenger Car	Passenger Car	At Intersection and Related	Clear or Partly Cloudy	Dry	Daylight	From opposite direction - one left turn - one straight	Making Left Turn	Going Straight Ahead	South	West	North	South	Unknown Driver Distraction							None					Lane of Primary Trafficway	1125323.57	143329.82		
County Road	Clark		94100	6.110			24190	0.000					No	E570841	08/05/2016	11:53	Possible Injury	2	0	0	0	Pickup,Panel Truck or Vanette under 10,000 lb	Passenger Car	At Intersection and Related	Clear or Partly Cloudy	Dry	Daylight	From opposite direction - one left turn - one straight	Making Left Turn	Going Straight Ahead	East	South	West	East	Apparently Fatigued							None					Lane of Primary Trafficway	1125323.55	143329.82		
County Road	Clark		94100	6.110			24190	0.000					No	E591234	10/01/2016	14:02	No Apparent Injury	0	0	0	0	Passenger Car	Pickup,Panel Truck or Vanette under 10,000 lb	At Intersection and Related	Clear or Partly Cloudy	Dry	Daylight	From opposite direction - one left turn - one straight	Making Left Turn	Going Straight Ahead	East	South	West	East	Did Not Grant RW to Vehicle							None					Lane of Primary Trafficway	1125323.55	143329.82		
County Road	Clark		94100	6.110			24190	0.000					No	E622051	12/18/2016	18:54	Suspected Minor Injury	2	0	0	0	Passenger Car	Pickup,Panel Truck or Vanette under 10,000 lb	At Intersection and Related	Other	Wet	Dark-Street Lights On	Entering at angle	Going Straight Ahead	Going Straight Ahead	West	East	South	North	Disregard Stop and Go Light	Inattention							Driver Not Distracted						Lane of Primary Trafficway	1125323.56	143329.83
County Road	Clark		94100	6.110			24190	0.000					No	E650259	03/10/2017	18:35	Possible Injury	1	0	0	0	Passenger Car	Pickup,Panel Truck or Vanette under 10,000 lb	At Intersection and Related	Clear or Partly Cloudy	Dry	Dark-Street Lights	Entering at angle	Making Left Turn	Going Straight Ahead	North	East	West	East	Disregard Stop and Go Light							None					Lane of Primary Trafficway	1125323.56	143329.83		
County Road	Clark		94100	6.110			24190	0.000					No	E711580	09/13/2017	18:48	Died in Hospital	0	1	2	0	Pickup,Panel Truck or Vanette under 10,000 lb	Motorcycle	At Intersection and Related	Clear or Partly Cloudy	Dry	Dusk	Entering at angle	Going Straight Ahead	Going Straight Ahead	West	East	South	North	Disregard Stop and Go Light							None					Lane of Primary Trafficway	1125323.56	143329.83		
County Road	Clark		94100	6.110			24190	0.000					No	E712268	09/14/2017	22:16	No Apparent Injury	0	0	0	0	Passenger Car	Passenger Car	At Intersection and Related	Clear or Partly Cloudy	Dry	Dark-Street Lights On	Entering at angle	Going Straight Ahead	Going Straight Ahead	West	East	South	North	Disregard Stop and Go Light							None					Lane of Primary Trafficway	1125323.56	143329.83		
County Road	Clark		94100	6.110			24190	0.000					No	E724621	10/17/2017	17:45	Possible Injury	1	0	0	0	Pickup,Panel Truck or Vanette under 10,000 lb	Pickup,Panel Truck or Vanette under 10,000 lb	At Intersection and Related	Clear or Partly Cloudy	Wet	Daylight	Entering at angle	Going Straight Ahead	Going Straight Ahead	East	West	South	North	Disregard Stop and Go Light							None					Lane of Primary Trafficway	1125323.56	143329.83		
State Route	Clark		500	8.73	B								No	E345151	07/29/2014	01:00	No Apparent Injury	0	0	0	0	Passenger Car	Passenger Car	At Intersection and Not Related	Clear or Partly Cloudy	Dry	Dark-Street Lights On	From opposite direction - both going straight - sideswipe	Going Straight Ahead	Going Straight Ahead	North	South	South	North	None							Other					Intersecting Road Increasing Milepost	1125089.87	134047.34		
State Route	Clark		500	8.73	B								No	E374555	11/13/2014	18:01	Possible Injury	1	0	0	0	Passenger Car	Passenger Car	At Intersection and Related	Sleet or Hail or Freezing Rain	Wet	Dark-Street Lights On	From opposite direction - one left turn - one straight	Making Left Turn	Going Straight Ahead	North	East	South	North	Improper Turn	Inattention							None					Left Turn Lane Decreasing Milepost	1125089.87	134047.34	
State Route	Clark		500	8.73	B								No	E382379	12/08/2014	16:09	No Apparent Injury	0	0	0	0	Passenger Car	Pickup,Panel Truck or Vanette under 10,000 lb	At Intersection and Related	Overcast	Dry	Daylight	From same direction - both going straight - one stopped - sideswipe	Changing Lanes	Stopped for Traffic	West	East	West	North	Vehicle Stopped	Inattention	Did Not Grant RW to Vehicle							None					Left Turn Lane Increasing Milepost	1125087.87	134047.4
State Route	Clark		500	8.73	B								No	E428751	05/20/2015	22:00	No Apparent Injury	0	0	0	0	Pickup,Panel Truck or Vanette under 10,000 lb	Passenger Car	At Intersection and Related	Clear or Partly Cloudy	Dry	Dark-Street Lights On	From opposite direction - one left turn - one straight	Slowing	Making Left Turn	East	West	West	North	Under influence of Alcohol	Disregard Stop and Go Light							Driver Not Distracted						Lane 1 Decreasing Milepost	1125095.09	134047.16
State Route	Clark		500	8.73	B								No	E480875	11/08/2015	09:45	Possible Injury	3	0	0	0	Passenger Car	Pickup,Panel Truck or Vanette under 10,000 lb	At Intersection and Related	Overcast	Wet	Daylight	Entering at angle	Going Straight Ahead	Going Straight Ahead	North	South	East	West	Disregard Stop and Go Light							None					Lane 1 Decreasing Milepost	1125098.43	134044.26		
State Route	Clark		500	8.73	B								No	E492779	12/05/2015	12:05	Possible Injury	2	0	0	0	Passenger Car	Pickup,Panel Truck or Vanette under 10,000 lb	At Intersection and Related	Raining	Wet	Daylight	From opposite direction - one left turn - one straight	Going Straight Ahead	Making Left Turn	East	West	West	North	Disregard Stop and Go Light	Inattention							None					Lane 2 Decreasing Milepost	1125090.73	134047.31	
State Route	Clark		500	8.73	B								No	E513028	02/06/2016	11:08	No Apparent Injury	0	0	1	0	Passenger Car		At Intersection and Related	Overcast	Dry	Daylight	Tree or Stump (stationary)	Making Right Turn		West	South															Past Right Shoulder Increasing Milepost	1125089	134045.5		
State Route	Clark		500	8.73	B								No	E518459	02/17/2016	15:48	Possible Injury	1	0	0	0	Passenger Car	Pickup,Panel Truck or Vanette under 10,000 lb	At Intersection and Related	Raining	Wet	Daylight	From opposite direction - one left turn - one straight	Making Left Turn	Going Straight Ahead	South	West	North	South	Did Not Grant RW to Vehicle							None						Lane 1 Increasing Milepost	1125091.34	134047.6	
State Route	Clark		500	8.73	B								No	E546264	05/16/2016	12:22	Possible Injury	1	0	0	0	Not Stated	Passenger Car	At Intersection and Related	Overcast	Dry	Daylight	From same direction - both going straight - one stopped - rear-end	Going Straight Ahead	Stopped at Signal or Stop Sign	South	North	Vehicle Stopped	Vehicle Stopped	Follow Too Closely							None					Intersecting Road Increasing Milepost	1125090.02	134046.57		
State Route	Clark		500	8.73	B								No	E560211	06/27/2016	18:49	No Apparent Injury	0	0	0	0	Passenger Car	Passenger Car	At Intersection and Related	Clear or Partly Cloudy	Dry	Daylight	From opposite direction - one left turn - one straight	Going Straight Ahead	Making Left Turn	East	West	West	North	None							Improper Turn						Lane 2 Decreasing Milepost	1125095.09	134047.16	

OFFICER REPORTED CRASHES THAT OCCURRED AT THE FOLLOWING INTERSECTIONS IN CLARK COUNTY

- 152nd Ave - north leg (Co Rd #51390, MP 0.000 - 0.020) @ 119th St (Co Rd #94100, MP 6.090 - 6.130)
- 152nd Ave - south leg (Co Rd #24190, MP 0.000 - 0.020) @ 119th St (Co Rd #94100, MP 6.090 - 6.130)
- 152nd Ave (Co Rd #24190, MP 0.980 - 1.020) @ 99th St (Co Rd #23940, MP 0.980 - 1.020)
- SR 500 (aka Padden Pkwy, MP 8.678 - 8.768) @ 152nd Ave (Co Rd, MP 24190, MP 1.730 - 1.770)
- SR 503 (aka 117th Ave, MP 1.71 - 1.84) @ 99th St (Co Rd #23940, 2.740 - 2.780)

01/01/2014 - available 2018

Under 23 U.S. Code § 409 and 23 U.S. Code § 148, safety data, reports, surveys, schedules, lists compiled or collected for the purpose of identifying, evaluating, or planning the safety enhancement of potential crash sites, hazardous roadway conditions, or railway-highway crossings are not subject to discovery or admitted into evidence in a Federal or State court proceeding or considered for other purposes in any action for damages arising from any occurrence at a location mentioned or addressed in such reports, surveys, schedules, lists, or data.

JURISDICTION	COUNTY	CITY	PRIMARY TRAFFICWAY	MILEPOST	A/B	BLOCK NUMBER	INTERSECTING TRAFFICWAY	CO ONLY INTERSECTING COUNTY ROAD MILEPOST	DIST FROM REF POINT	Mi or FT	COMP DIR FROM REF POINT	REFERENCE POINT NAME	SR ONLY HISTORY / SUSPENSE IND	REPORT NUMBER	DATE	TIME	MOST SEVERE INJURY TYPE	# FATAL	# INJURY	# PROPERTY DAMAGE	VEHICLE 1 TYPE	VEHICLE 2 TYPE	JUNCTION RELATIONSHIP	WEATHER	ROADWAY SURFACE CONDITION	LIGHTING CONDITION	FIRST COLLISION TYPE / OBJECT STRUCK	VEHICLE 1 ACTION	VEHICLE 2 ACTION	VEHICLE 1 COMPASS DIRECTION FROM	VEHICLE 1 COMPASS DIRECTION TO	VEHICLE 2 COMPASS DIRECTION FROM	VEHICLE 2 COMPASS DIRECTION TO	MV DRIVER CONTRIBUTING CIRCUMSTANCE 1 (UNIT 1)	MV DRIVER CONTRIBUTING CIRCUMSTANCE 2 (UNIT 1)	MV DRIVER CONTRIBUTING CIRCUMSTANCE 3 (UNIT 1)	MV DRIVER CONTRIBUTING CIRCUMSTANCE 1 (UNIT 2)	MV DRIVER CONTRIBUTING CIRCUMSTANCE 2 (UNIT 2)	PEDESTRIAN CONTRIBUTING CIRCUMSTANCE 1 (UNIT 2)	PEDESTRIAN CONTRIBUTING CIRCUMSTANCE 2 (UNIT 2)	FIRST IMPACT LOCATION (City, County & Misc Trafficways - 2010 forward)	WA STATE PLANE SOUTH - X 2010 - FORWARD	WA STATE PLANE SOUTH - Y 2010 - FORWARD										
State Route	Clark		500	8.73	B								No	E578847	08/27/2016	18:48	Suspected Minor Injury	1	0	0	Pickup,Panel Truck or Vanette under 10,000 lb	Motorcycle	At Intersection and Related	Clear or Partly Cloudy	Dry	Daylight	From opposite direction - one left turn - one straight	Making Left Turn	Going Straight Ahead	West	North	East	West	Other	Inattention									Lane 1 Decreasing Milepost	1125084.82	134044.04							
State Route	Clark		500	8.73	B								No	E581183	08/27/2016	20:15	No Apparent Injury	0	0	1	0	0	0	0	0	0	0	0	0	0	0	0	0	0	0	0	0	0	0	0	0	0	0	0	0	0	0	0	0	Past Right Shoulder Increasing Milepost	1125090.04	134047.26	
State Route	Clark		500	8.73	B								No	E594146	10/09/2016	19:05	Suspected Minor Injury	1	0	2	0	0	0	0	0	0	0	0	0	0	0	0	0	0	0	0	0	0	0	0	0	0	0	0	0	0	0	0	0	0	Lane 2 Decreasing Milepost	1125078.62	134045.91
State Route	Clark		500	8.73	B								No	E624568	12/18/2016	18:39	Suspected Minor Injury	1	0	2	0	0	0	0	0	0	0	0	0	0	0	0	0	0	0	0	0	0	0	0	0	0	0	0	0	0	0	0	0	0	Lane 1 Decreasing Milepost	1125088.55	134046.19
State Route	Clark		500	8.73	B								No	E640310	02/08/2017	12:47	Suspected Minor Injury	3	0	2	0	0	0	0	0	0	0	0	0	0	0	0	0	0	0	0	0	0	0	0	0	0	0	0	0	0	0	0	0	0	Lane 1 Decreasing Milepost	1125095.09	134047.16
State Route	Clark		500	8.73	B								No	E718694	09/22/2017	23:45	Possible Injury	1	0	2	0	0	0	0	0	0	0	0	0	0	0	0	0	0	0	0	0	0	0	0	0	0	0	0	0	0	0	0	0	0	Lane 2 Decreasing Milepost	1125095.09	134047.16
State Route	Clark		500	8.73	B								No	E742312	11/30/2017	17:52	Suspected Minor Injury	2	0	2	0	0	0	0	0	0	0	0	0	0	0	0	0	0	0	0	0	0	0	0	0	0	0	0	0	0	0	0	0	0	Lane 1 Decreasing Milepost	1125092.19	134046.04
State Route	Clark		500	8.73	B								No	E743503	11/29/2017	17:21	Possible Injury	1	0	2	0	0	0	0	0	0	0	0	0	0	0	0	0	0	0	0	0	0	0	0	0	0	0	0	0	0	0	0	0	Lane 2 Decreasing Milepost	1125088.96	134047.26	
State Route	Clark		500	8.73	B								No	E753660	12/29/2017	16:55	Possible Injury	1	0	2	0	0	0	0	0	0	0	0	0	0	0	0	0	0	0	0	0	0	0	0	0	0	0	0	0	0	0	0	0	Lane 2 Decreasing Milepost	1125089.95	134044.68	
State Route	Clark		500	8.73	B								No	E770822	02/18/2018	22:08	Possible Injury	1	0	2	0	0	0	0	0	0	0	0	0	0	0	0	0	0	0	0	0	0	0	0	0	0	0	0	0	0	0	0	0	Lane 2 Increasing Milepost	1125095.05	134046.11	
State Route	Clark		500	8.73	B								No	E784361	03/25/2018	21:16	Possible Injury	1	0	2	0	0	0	0	0	0	0	0	0	0	0	0	0	0	0	0	0	0	0	0	0	0	0	0	0	0	0	0	0	Lane 2 Decreasing Milepost	1125092.02	134045.78	
State Route	Clark		500	8.73	B								No	E807828	06/08/2018	18:48	Possible Injury	1	0	2	0	0	0	0	0	0	0	0	0	0	0	0	0	0	0	0	0	0	0	0	0	0	0	0	0	0	0	0	0	Lane 1 Decreasing Milepost	1125091.88	134045.96	
State Route	Clark		500	8.73	B								No	E810889	06/15/2018	21:42	No Apparent Injury	0	0	2	0	0	0	0	0	0	0	0	0	0	0	0	0	0	0	0	0	0	0	0	0	0	0	0	0	0	0	0	0	Lane 2 Increasing Milepost	1125090.35	134045.57	
State Route	Clark		500	8.73	B								No	E811243	06/16/2018	10:55	No Apparent Injury	0	0	2	0	0	0	0	0	0	0	0	0	0	0	0	0	0	0	0	0	0	0	0	0	0	0	0	0	0	0	0	Lane 2 Decreasing Milepost	1125095.09	134047.16		
State Route	Clark		500	8.73	B								No	E821884	07/12/2018	00:11	No Apparent Injury	0	0	2	0	0	0	0	0	0	0	0	0	0	0	0	0	0	0	0	0	0	0	0	0	0	0	0	0	0	0	0	0	Lane 2 Decreasing Milepost	1125095.09	134047.16	
State Route	Clark		500	8.73	B								No	E855830	10/26/2018	09:28	No Apparent Injury	0	0	2	0	0	0	0	0	0	0	0	0	0	0	0	0	0	0	0	0	0	0	0	0	0	0	0	0	0	0	0	0	Lane 2 Decreasing Milepost	1125095.66	134047.14	
State Route	Clark		503	1.71									No	E332263	05/28/2014	18:30	No Apparent Injury	0	0	2	0	0	0	0	0	0	0	0	0	0	0	0	0	0	0	0	0	0	0	0	0	0	0	0	0	0	0	0	Lane 2 Increasing Milepost	1115866.71	137661.67		
State Route	Clark		503	1.72									No	E745686	11/30/2017	18:03	No Apparent Injury	0	0	3	0	0	0	0	0	0	0	0	0	0	0	0	0	0	0	0	0	0	0	0	0	0	0	0	0	0	0	0	Lane 1 Increasing Milepost	1115869.37	137689.94		
State Route	Clark		503	1.74									No	E761643	01/18/2018	20:03	No Apparent Injury	0	0	2	0	0	0	0	0	0	0	0	0	0	0	0	0	0	0	0	0	0	0	0	0	0	0	0	0	0	0	Lane 2 Increasing Milepost	1115869.6	137800.52			

OFFICER REPORTED CRASHES THAT OCCURRED AT THE FOLLOWING INTERSECTIONS IN CLARK COUNTY

152nd Ave - north leg (Co Rd #51390, MP 0.000 - 0.020) @ 119th St (Co Rd #94100, MP 6.090 - 6.130)
 152nd Ave - south leg (Co Rd #24190, MP 0.000 - 0.020) @ 119th St (Co Rd #94100, MP 6.090 - 6.130)
 152nd Ave (Co Rd #24190, MP 0.980 - 1.020) @ 99th St (Co Rd #23940, MP 0.980 - 1.020)
 SR 500 (aka Padden Pkwy, MP 8.678 - 8.768) @ 152nd Ave (Co Rd, MP 24190, MP 1.730 - 1.770)
 SR 503 (aka 117th Ave, MP 1.71 - 1.84) @ 99th St (Co Rd #23940, 2.740 - 2.780)

01/01/2014 - available 2018

Under 23 U.S. Code § 409 and 23 U.S. Code § 148, safety data, reports, surveys, schedules, lists compiled or collected for the purpose of identifying, evaluating, or planning the safety enhancement of potential crash sites, hazardous roadway conditions, or railway-highway crossings are not subject to discovery or admitted into evidence in a Federal or State court proceeding or considered for other purposes in any action for damages arising from any occurrence at a location mentioned or addressed in such reports, surveys, schedules, lists, or data.

JURISDICTION	COUNTY	CITY	PRIMARY TRAFFICWAY	MILEPOST	A/B	BLOCK NUMBER	INTERSECTING TRAFFICWAY	CO ONLY INTERSECTING COUNTY ROAD MILEPOST	DIST FROM REF POINT	MI or FT	COMP DIR FROM REF POINT	REFERENCE POINT NAME	SR ONLY HISTORY / SUSPENSE IND	REPORT NUMBER	DATE	TIME	MOST SEVERE INJURY TYPE	# FATALS	# INJURIES	# PROPERTY DAMAGE	VEHICLE 1 TYPE	VEHICLE 2 TYPE	JUNCTION RELATIONSHIP	WEATHER	ROADWAY SURFACE CONDITION	LIGHTING CONDITION	FIRST COLLISION TYPE / OBJECT STRUCK	VEHICLE 1 ACTION	VEHICLE 2 ACTION	VEHICLE 1 COMPASS DIRECTION FROM	VEHICLE 1 COMPASS DIRECTION TO	VEHICLE 2 COMPASS DIRECTION FROM	VEHICLE 2 COMPASS DIRECTION TO	MV DRIVER CONTRIBUTING CIRCUMSTANCE 1 (UNIT 1)	MV DRIVER CONTRIBUTING CIRCUMSTANCE 2 (UNIT 1)	MV DRIVER CONTRIBUTING CIRCUMSTANCE 3 (UNIT 1)	MV DRIVER CONTRIBUTING CIRCUMSTANCE 1 (UNIT 2)	MV DRIVER CONTRIBUTING CIRCUMSTANCE 2 (UNIT 2)	PEDESTRIAN CONTRIBUTING CIRCUMSTANCE 1 (UNIT 2)	PEDESTRIAN CONTRIBUTING CIRCUMSTANCE 2 (UNIT 2)	FIRST IMPACT LOCATION (City, County & Misc Trafficways - 2010 forward)	WA STATE PLANE SOUTH - X 2010 - FORWARD	WA STATE PLANE SOUTH - Y 2010 - FORWARD							
State Route	Clark		503	1.77									No	E552365	06/07/2016	14:30	Possible Injury	1	0	0	Pickup,Panel Truck or Vanette under 10,000 lb	Pickup,Panel Truck or Vanette under 10,000 lb	Not at Intersection and Not Related	Clear or Partly Cloudy	Dry	Daylight	From same direction - both going straight - both moving - rear-end	Going Straight Ahead	Starting in Traffic Lane	South	North	South	North	Inattention	Follow Too Closely									Lane 2 Increasing Milepost	1115874.61	137987.56				
State Route	Clark		503	1.78									No	E821399	07/05/2018	20:29	Possible Injury	2	0	3	Pickup,Panel Truck or Vanette under 10,000 lb	Pickup,Panel Truck or Vanette under 10,000 lb	Intersection Related but Not at Intersection	Clear or Partly Cloudy	Dry	Dusk	From same direction - both going straight - one stopped - rear-end	Starting in Traffic Lane	Stopped for Traffic	South	North	South	Vehicle Stopped	Inattention												Lane 2 Increasing Milepost	1115878.91	138025.19		
State Route	Clark		503	1.79									No	E862566	11/16/2018	20:04	Possible Injury	1	0	2	Passenger Car	Passenger Car	At Intersection and Related	Fog or Smog or Smoke	Wet	Dark-Street Lights On	From same direction - both going straight - one stopped - rear-end	Slowing	Stopped at Signal or Stop Sign	South	North	South	Vehicle Stopped	Exceeding Reas. Safe Speed												Lane 3 Increasing Milepost	1115878.42	138103.71		
State Route	Clark		503	1.80									No	E299077	01/08/2014	18:49	Possible Injury	1	0	1	Pickup,Panel Truck or Vanette under 10,000 lb		At Intersection and Related	Raining	Wet	Dark-Street Lights On	Vehicle turning left hits pedestrian	Making Left Turn		East	South			Driver Smoking												Lane 2 Decreasing Milepost	1115879.02	138138.35		
State Route	Clark		503	1.80									No	E341810	06/30/2014	17:30	No Apparent Injury	0	0	3	Passenger Car	Passenger Car	At Intersection and Related	Clear or Partly Cloudy	Dry	Daylight	From same direction - both going straight - one stopped - rear-end	Going Straight Ahead	Stopped at Signal or Stop Sign	South	North	South	Vehicle Stopped	Exceeding Reas. Safe Speed													Lane 1 Increasing Milepost	1115879.18	138143.68	
State Route	Clark		503	1.80									No	E350434	08/15/2014	07:53	No Apparent Injury	0	0	2	Pickup,Panel Truck or Vanette under 10,000 lb	Passenger Car	At Intersection and Related	Overcast	Dry	Daylight	From same direction - both going straight - both moving - sideswipe	Changing Lanes	Going Straight Ahead	North	South	North	South	Inattention	Did Not Grant RW to Vehicle		Other										Left Turn Lane Decreasing Milepost	1115879.02	138138.35	
State Route	Clark		503	1.80									No	E369809	10/28/2014	12:28	No Apparent Injury	0	0	2	Pickup,Panel Truck or Vanette under 10,000 lb	Pickup,Panel Truck or Vanette under 10,000 lb	At Intersection and Not Related	Other	Wet	Daylight	From same direction - both going straight - one stopped - rear-end	Going Straight Ahead	Stopped for Traffic	North	South	North	Vehicle Stopped	Inattention	Follow Too Closely												Lane 2 Decreasing Milepost	1115878.99	138137.21	
State Route	Clark		503	1.80									No	E379076	11/19/2014	20:33	Suspected Minor Injury	1	0	2	Pickup,Panel Truck or Vanette under 10,000 lb	Pickup,Panel Truck or Vanette under 10,000 lb	At Intersection and Related	Raining	Wet	Dark-Street Lights On	From opposite direction - one left turn - one straight	Making Left Turn	Going Straight Ahead	North	East	South	North	Did Not Grant RW to Vehicle													Lane 2 Increasing Milepost	1115879.02	138138.35	
State Route	Clark		503	1.80									No	E383599	12/12/2014	17:05	No Apparent Injury	0	0	2	Passenger Car	Pickup,Panel Truck or Vanette under 10,000 lb	At Intersection and Related	Raining	Wet	Dark-Street Lights On	From same direction - both going straight - one stopped - rear-end	Going Straight Ahead	Stopped for Traffic	East	West	Vehicle Stopped	Vehicle Stopped	Inattention													Intersecting Road Increasing Milepost	1115879.02	138138.35	
State Route	Clark		503	1.80									No	E395323	01/19/2015	19:47	No Apparent Injury	0	0	2	Pickup,Panel Truck or Vanette under 10,000 lb	Passenger Car	At Intersection and Related	Clear or Partly Cloudy	Dry	Dark-Street Lights On	From opposite direction - one left turn - one straight	Going Straight Ahead	Making Left Turn	South	North	North	East	Disregard Stop and Go Light	Driver Interacting with Passengers, Anim													Lane 1 Increasing Milepost	1115877.45	138141.93
State Route	Clark		503	1.80									No	E400962	02/07/2015	14:25	No Apparent Injury	0	0	2	Passenger Car	Passenger Car	At Intersection and Related	Raining	Wet	Daylight	From same direction - both going straight - both moving - rear-end	Slowing	Changing Lanes	South	North	South	North	Follow Too Closely													Left Turn Lane Increasing Milepost	1115879.02	138138.35	
State Route	Clark		503	1.80									No	E411835	03/28/2015	13:21	No Apparent Injury	0	0	2	Pickup,Panel Truck or Vanette under 10,000 lb	Pickup,Panel Truck or Vanette under 10,000 lb	At Intersection and Related	Clear or Partly Cloudy	Dry	Daylight	From same direction - both going straight - one stopped - rear-end	Starting in Traffic Lane	Stopped at Signal or Stop Sign	North	South	North	Vehicle Stopped	Inattention	Driver Interacting with Passengers, Anim	Follow Too Closely												Lane 1 Decreasing Milepost	1115878.18	138136.43
State Route	Clark		503	1.80									No	E413047	03/30/2015	08:19	No Apparent Injury	0	0	3	Pickup,Panel Truck or Vanette under 10,000 lb	Pickup,Panel Truck or Vanette under 10,000 lb	At Intersection and Related	Clear or Partly Cloudy	Dry	Daylight	From same direction - both going straight - one stopped - rear-end	Going Straight Ahead	Stopped at Signal or Stop Sign	North	South	North	Vehicle Stopped	Follow Too Closely														Lane 1 Decreasing Milepost	1115878.2	138135.55
State Route	Clark		503	1.80									No	E472408	10/12/2015	20:10	Suspected Minor Injury	2	0	2	Pickup,Panel Truck or Vanette under 10,000 lb	Pickup,Panel Truck or Vanette under 10,000 lb	At Intersection and Related	Clear or Partly Cloudy	Dry	Dark-Street Lights On	From opposite direction - one left turn - one straight	Making Left Turn	Going Straight Ahead	East	South	West	East	Inattention	Did Not Grant RW to Vehicle													Lane 3 Increasing Milepost	1115902.74	138135.63
State Route	Clark		503	1.80									No	E516192	02/12/2016	16:09	No Apparent Injury	0	0	2	Pickup,Panel Truck or Vanette under 10,000 lb	Passenger Car	At Intersection and Not Related	Overcast	Wet	Daylight	From same direction - both going straight - one stopped - rear-end	Going Straight Ahead	Stopped in Roadway	South	North	South	Vehicle Stopped	Exceeding Reas. Safe Speed														Lane 1 Increasing Milepost	1115879.87	138139.53

OFFICER REPORTED CRASHES THAT OCCURRED AT THE FOLLOWING INTERSECTIONS IN CLARK COUNTY

152nd Ave - north leg (Co Rd #51390, MP 0.000 - 0.020) @ 119th St (Co Rd #94100, MP 6.090 - 6.130)
 152nd Ave - south leg (Co Rd #24190, MP 0.000 - 0.020) @ 119th St (Co Rd #94100, MP 6.090 - 6.130)
 152nd Ave (Co Rd #24190, MP 0.980 - 1.020) @ 99th St (Co Rd #23940, MP 0.980 - 1.020)
 SR 500 (aka Padden Pkwy, MP 8.678 - 8.768) @ 152nd Ave (Co Rd, MP 24190, MP 1.730 - 1.770)
 SR 503 (aka 117th Ave, MP 1.71 - 1.84) @ 99th St (Co Rd #23940, 2.740 - 2.780)

01/01/2014 - available 2018

Under 23 U.S. Code § 409 and 23 U.S. Code § 148, safety data, reports, surveys, schedules, lists compiled or collected for the purpose of identifying, evaluating, or planning the safety enhancement of potential crash sites, hazardous roadway conditions, or railway-highway crossings are not subject to discovery or admitted into evidence in a Federal or State court proceeding or considered for other purposes in any action for damages arising from any occurrence at a location mentioned or addressed in such reports, surveys, schedules, lists, or data.

JURISDICTION	COUNTY	CITY	PRIMARY TRAFFICWAY	MILEPOST	A/B	BLOCK NUMBER	INTERSECTING TRAFFICWAY	CO ONLY INTERSECTING COUNTY ROAD MILEPOST	DIST FROM REF POINT	MI or FT	COMP DIR FROM REF POINT	REFERENCE POINT NAME	SR ONLY HISTORY / SUSPENSE IND	REPORT NUMBER	DATE	TIME	MOST SEVERE INJURY TYPE	# FATALS	# PERSONS INJURED	# VEHICLES INVOLVED	VEHICLE 1 TYPE	VEHICLE 2 TYPE	JUNCTION RELATIONSHIP	WEATHER	ROADWAY SURFACE CONDITION	LIGHTING CONDITION	FIRST COLLISION TYPE / OBJECT STRUCK	VEHICLE 1 ACTION	VEHICLE 2 ACTION	VEHICLE 1 COMPASS DIRECTION FROM	VEHICLE 1 COMPASS DIRECTION TO	VEHICLE 2 COMPASS DIRECTION FROM	VEHICLE 2 COMPASS DIRECTION TO	MV DRIVER CONTRIBUTING CIRCUMSTANCE 1 (UNIT 1)	MV DRIVER CONTRIBUTING CIRCUMSTANCE 2 (UNIT 1)	MV DRIVER CONTRIBUTING CIRCUMSTANCE 3 (UNIT 1)	MV DRIVER CONTRIBUTING CIRCUMSTANCE 1 (UNIT 2)	MV DRIVER CONTRIBUTING CIRCUMSTANCE 2 (UNIT 2)	PEDESTRIAN CONTRIBUTING CIRCUMSTANCE 1 (UNIT 2)	PEDESTRIAN CONTRIBUTING CIRCUMSTANCE 2 (UNIT 2)	FIRST IMPACT LOCATION (City, County & Misc Trafficways - 2010 forward)	WA STATE PLANE SOUTH - X 2010 - FORWARD	WA STATE PLANE SOUTH - Y 2010 - FORWARD									
State Route	Clark		503	1.80									No	E530396	03/26/2016	22:03	Possible Injury	1	0	2	0	Pickup,Panel Truck or Vanette under 10,000 lb	Pickup,Panel Truck or Vanette under 10,000 lb	At Intersection and Related	Overcast	Wet	Dark-Street Lights On	From same direction - both going straight - one stopped - rear-end	Starting in Traffic Lane	Stopped for Traffic	South	North	South	Vehicle Stopped	Driver Operating Handheld Telecommunicat	Follow Too Closely									Lane 2 Increasing Milepost	1115879.02	138138.35					
State Route	Clark		503	1.80									No	E532800	04/08/2016	07:42	No Apparent Injury	0	0	2	0	Passenger Car	Pickup,Panel Truck or Vanette under 10,000 lb	At Intersection and Related	Clear or Partly Cloudy	Dry	Daylight	From same direction - both going straight - one stopped - rear-end	Going Straight Ahead	Stopped for Traffic	North	South	North	Vehicle Stopped	Follow Too Closely												Lane 1 Decreasing Milepost	1115879.02	138138.35			
State Route	Clark		503	1.80									No	E540411	05/04/2016	20:22	Suspected Serious Injury	1	0	2	0	Passenger Car	Motorcycle	At Intersection and Related	Clear or Partly Cloudy	Dry	Dark-Street Lights On	From same direction - all others	Backing	Stopped for Traffic	Vehicle Backing	Vehicle Backing	Vehicle Stopped	Vehicle Stopped	Improper Backing											Intersecting Road Decreasing Milepost	1115902.74	138135.63				
State Route	Clark		503	1.80									No	E547466	05/26/2016	07:55	No Apparent Injury	0	0	2	0	Pickup,Panel Truck or Vanette under 10,000 lb	Passenger Car	At Intersection and Related	Clear or Partly Cloudy	Dry	Daylight	From same direction - both going straight - one stopped - rear-end	Going Straight Ahead	Stopped at Signal or Stop Sign	North	South	Vehicle Stopped	Vehicle Stopped	Exceeding Reas. Safe Speed	Driver Operating Handheld Telecommunicat											Lane 1 Decreasing Milepost	1115879.59	138140.34			
State Route	Clark		503	1.80									No	E560938	06/29/2016	21:35	No Apparent Injury	0	0	3	0	Passenger Car	Passenger Car	At Intersection and Related	Clear or Partly Cloudy	Dry	Dark-Street Lights On	From same direction - both going straight - one stopped - rear-end	Going Straight Ahead	Stopped at Signal or Stop Sign	South	North	Vehicle Stopped	Vehicle Stopped	Under Influence of Alcohol	Follow Too Closely												Lane 2 Increasing Milepost	1115879.02	138138.35		
State Route	Clark		503	1.80									No	E579877	08/28/2016	11:54	No Apparent Injury	0	0	2	0	Pickup,Panel Truck or Vanette under 10,000 lb	Passenger Car	At Intersection and Related	Clear or Partly Cloudy	Dry	Daylight	From opposite direction - one left turn - one straight	Going Straight Ahead	Making Left Turn	Southeast	North	North	East	Disregard Stop and Go Light													Lane 2 Increasing Milepost	1115881.91	138148.16		
State Route	Clark		503	1.80									No	E603024	10/21/2016	18:53	Suspected Minor Injury	4	0	3	0	Pickup,Panel Truck or Vanette under 10,000 lb	Passenger Car	At Intersection and Related	Raining	Wet	Dark-Street Lights On	From same direction - both going straight - one stopped - rear-end	Slowing	Stopped for Traffic	South	North	South	Vehicle Stopped	Inattention	Follow Too Closely												Left Turn Lane Increasing Milepost	1115877.92	138138.38		
State Route	Clark		503	1.80									No	E613070	11/24/2016	16:27	Possible Injury	1	0	2	0	Passenger Car	Passenger Car	At Intersection and Related	Raining	Wet	Dark-Street Lights On	From same direction - both going straight - both moving - rear-end	Going Straight Ahead	Slowing	North	South	North	South	Under Influence of Alcohol													Lane 2 Decreasing Milepost	1115879.02	138138.35		
State Route	Clark		503	1.80									No	E626663	12/21/2016	21:17	No Apparent Injury	0	0	2	0	Passenger Car	Pickup,Panel Truck or Vanette under 10,000 lb	At Intersection and Related	Fog or Smog or Smoke	Dry	Dark-Street Lights On	Entering at angle	Making Right Turn	Going Straight Ahead	East	North	South	North	Improper Turn														Lane 1 Increasing Milepost	1115878.82	138140.04	
State Route	Clark		503	1.80									No	E636855	01/28/2017	18:19	Possible Injury	1	0	2	0	Passenger Car	Pickup,Panel Truck or Vanette under 10,000 lb	At Intersection and Related	Clear or Partly Cloudy	Dry	Dark-Street Lights On	From opposite direction - one left turn - one straight	Making Left Turn	Going Straight Ahead	East	South	West	East	Did Not Grant RW to Vehicle													Left Turn Lane Increasing Milepost	1115879.94	138137.01		
State Route	Clark		503	1.80									No	E758990	01/12/2018	18:32	Possible Injury	1	0	2	0	Pickup,Panel Truck or Vanette under 10,000 lb	Pickup,Panel Truck or Vanette under 10,000 lb	At Intersection and Related	Clear or Partly Cloudy	Wet	Dark-Street Lights On	From same direction - both going straight - one stopped - rear-end	Slowing	Stopped at Signal or Stop Sign	South	North	South	Vehicle Stopped	Inattention	Exceeding Reas. Safe Speed													Lane 3 Increasing Milepost	1115879.04	138139.05	
State Route	Clark		503	1.80									No	E789780	04/11/2018	18:30	No Apparent Injury	0	0	2	0	Passenger Car	Pickup,Panel Truck or Vanette under 10,000 lb	At Intersection and Related	Raining	Wet	Dusk	From same direction - both going straight - one stopped - rear-end	Going Straight Ahead	Stopped at Signal or Stop Sign	East	West	East	Vehicle Stopped	Exceeding Reas. Safe Speed													Intersecting Road Increasing Milepost	1115880.63	138139.61		
State Route	Clark		503	1.80									No	E791725	04/20/2018	22:10	No Apparent Injury	0	0	2	0	Passenger Car	Pickup,Panel Truck or Vanette under 10,000 lb	At Intersection and Related	Clear or Partly Cloudy	Dry	Dark-Street Lights On	From opposite direction - one left turn - one straight	Making Left Turn	Going Straight Ahead	South	West	North	South	Disregard Stop and Go Light														Lane 2 Decreasing Milepost	1115881.1	138142.87	
State Route	Clark		503	1.80									No	E818979	07/16/2018	14:38	Suspected Minor Injury	1	0	2	0	Pickup,Panel Truck or Vanette under 10,000 lb	Pickup,Panel Truck or Vanette under 10,000 lb	At Intersection and Related	Clear or Partly Cloudy	Dry	Daylight	From opposite direction - one left turn - one straight	Making Left Turn	Going Straight Ahead	East	South	West	East	Inattention														Lane 2 Decreasing Milepost	1115902.74	138135.66	
State Route	Clark		503	1.80									No	E819410	07/10/2018	23:08	No Apparent Injury	0	0	2	0	Passenger Car	Pickup,Panel Truck or Vanette under 10,000 lb	At Intersection and Related	Clear or Partly Cloudy	Dry	Dark-No Street Lights	From opposite direction - one left turn - one straight	Going Straight Ahead	Making Left Turn	South	North	North	East	None														Lane 2 Increasing Milepost	1115879.51	138139.04	
State Route	Clark		503	1.80									No	E839747	08/31/2018	13:42	No Apparent Injury	0	0	2	0	Pickup,Panel Truck or Vanette under 10,000 lb	Passenger Car	At Intersection and Related	Clear or Partly Cloudy	Dry	Daylight	From opposite direction - one left turn - one straight	Making Left Turn	Going Straight Ahead	East	South	West	North	Did Not Grant RW to Vehicle															Left Turn Lane Increasing Milepost	1115878.91	138138.04

OFFICER REPORTED CRASHES THAT OCCURRED AT THE FOLLOWING INTERSECTIONS IN CLARK COUNTY

- 152nd Ave - north leg (Co Rd #51390, MP 0.000 - 0.020) @ 119th St (Co Rd #94100, MP 6.090 - 6.130)
- 152nd Ave - south leg (Co Rd #24190, MP 0.000 - 0.020) @ 119th St (Co Rd #94100, MP 6.090 - 6.130)
- 152nd Ave (Co Rd #24190, MP 0.980 - 1.020) @ 99th St (Co Rd #23940, MP 0.980 - 1.020)
- SR 500 (aka Padden Pkwy, MP 8.678 - 8.768) @ 152nd Ave (Co Rd, MP 24190, MP 1.730 - 1.770)
- SR 503 (aka 117th Ave, MP 1.71 - 1.84) @ 99th St (Co Rd #23940, 2.740 - 2.780)

01/01/2014 - available 2018

Under 23 U.S. Code § 409 and 23 U.S. Code § 148, safety data, reports, surveys, schedules, lists compiled or collected for the purpose of identifying, evaluating, or planning the safety enhancement of potential crash sites, hazardous roadway conditions, or railway-highway crossings are not subject to discovery or admitted into evidence in a Federal or State court proceeding or considered for other purposes in any action for damages arising from any occurrence at a location mentioned or addressed in such reports, surveys, schedules, lists, or data.

JURISDICTION	COUNTY	CITY	PRIMARY TRAFFICWAY	MILEPOST	A/B	BLOCK NUMBER	INTERSECTING TRAFFICWAY	CO ONLY INTERSECTING COUNTY ROAD MILEPOST	DIST FROM REF POINT	MI or FT	COMP DIR FROM REF POINT	REFERENCE POINT NAME	SR ONLY HISTORY / SUSPENSE IND	REPORT NUMBER	DATE	TIME	MOST SEVERE INJURY TYPE	# I N J U R I E S	# F A T A L I T I E S	# P E R M A N E N T D I S A B I L I T I E S	VEHICLE 1 TYPE	VEHICLE 2 TYPE	JUNCTION RELATIONSHIP	WEATHER	ROADWAY SURFACE CONDITION	LIGHTING CONDITION	FIRST COLLISION TYPE / OBJECT STRUCK	VEHICLE 1 ACTION	VEHICLE 2 ACTION	VEHICLE 1 COMPASS DIRECTION FROM	VEHICLE 1 COMPASS DIRECTION TO	VEHICLE 2 COMPASS DIRECTION FROM	VEHICLE 2 COMPASS DIRECTION TO	MV DRIVER CONTRIBUTING CIRCUMSTANCE 1 (UNIT 1)	MV DRIVER CONTRIBUTING CIRCUMSTANCE 2 (UNIT 1)	MV DRIVER CONTRIBUTING CIRCUMSTANCE 3 (UNIT 1)	MV DRIVER CONTRIBUTING CIRCUMSTANCE 1 (UNIT 2)	MV DRIVER CONTRIBUTING CIRCUMSTANCE 2 (UNIT 2)	PEDESTRIAN CONTRIBUTING CIRCUMSTANCE 1 (UNIT 2)	PEDESTRIAN CONTRIBUTING CIRCUMSTANCE 2 (UNIT 2)	FIRST IMPACT LOCATION (City, County & Misc Trafficways - 2010 forward)	WA STATE PLANE SOUTH - X 2010 - FORWARD	WA STATE PLANE SOUTH - Y 2010 - FORWARD							
State Route	Clark		503	1.80									No	E853531	10/20/2018	16:27	Possible Injury	1	0	2	0	Passenger Car	Pickup,Panel Truck or Vanette under 10,000 lb	At Intersection and Related	Clear or Partly Cloudy	Dry	Daylight	From same direction - both going straight - one stopped - rear-end	Going Straight Ahead	Stopped at Signal or Stop Sign	South	North	South	Vehicle Stopped	Inattention	Follow Too Closely									Lane 3 Increasing Milepost	1115879.04	138139.05			
State Route	Clark		503	1.81									No	E757537	01/11/2018	12:35	No Apparent Injury	0	0	2	0	Passenger Car	Pickup,Panel Truck or Vanette under 10,000 lb	Intersection Related but Not at Intersection	Raining	Wet	Daylight	From same direction - both going straight - both moving - rear-end	Going Straight Ahead	Slowing	North	South	North	South	Under Influence of Drugs											Lane 2 Decreasing Milepost	1115880.52	138188.98		
State Route	Clark		503	1.82									No	E780183	03/10/2018	10:29	Possible Injury	2	0	3	0	Pickup,Panel Truck or Vanette under 10,000 lb	Passenger Car	Intersection Related but Not at Intersection	Clear or Partly Cloudy	Dry	Daylight	From same direction - both going straight - one stopped - rear-end	Going Straight Ahead	Stopped for Traffic	North	South	North	Vehicle Stopped	Inattention	Follow Too Closely											Lane 1 Decreasing Milepost	1115881.99	138238.54	
State Route	Clark		503	1.82									No	E781875	03/11/2018	16:01	No Apparent Injury	0	0	4	0	Pickup,Panel Truck or Vanette under 10,000 lb		Intersection Related but Not at Intersection	Clear or Partly Cloudy	Dry	Daylight	Linear Curb	Going Straight Ahead		South	North			Under Influence of Alcohol	Driver Operating Handheld Telecommunicat											Median Shoulder Increasing Milepost	1115880.87	138237.11	
State Route	Clark		503	1.83									No	E386499	12/23/2014	11:54	No Apparent Injury	0	0	2	0	Passenger Car	Pickup,Panel Truck or Vanette under 10,000 lb	At Intersection and Not Related	Overcast	Wet	Daylight	From opposite direction - all others	Going Straight Ahead	Stopped for Traffic	South	North	North	Vehicle Stopped	Inattention	Exceeding Reas. Safe Speed												Left Turn Lane Decreasing Milepost	1115883.05	138274.29

APPENDIX D

RTC MODEL VOLUMES AND TURNSW32 WORKSHEETS

Enter Turning Counts

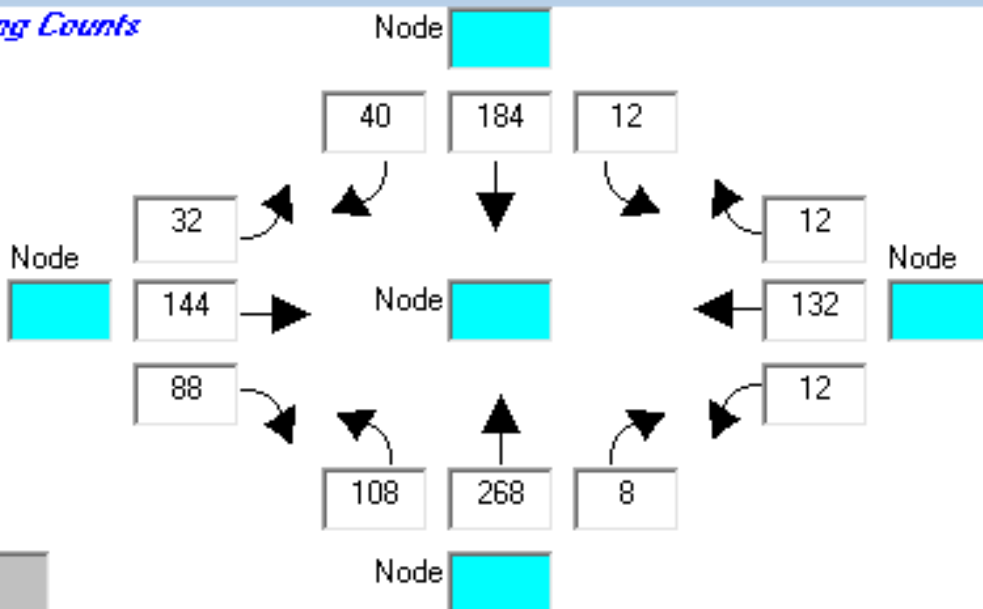

- Count data
- Turn %-ages

Previous

Next

1 of 1

Enter Forecast Approach & Departure Volumes

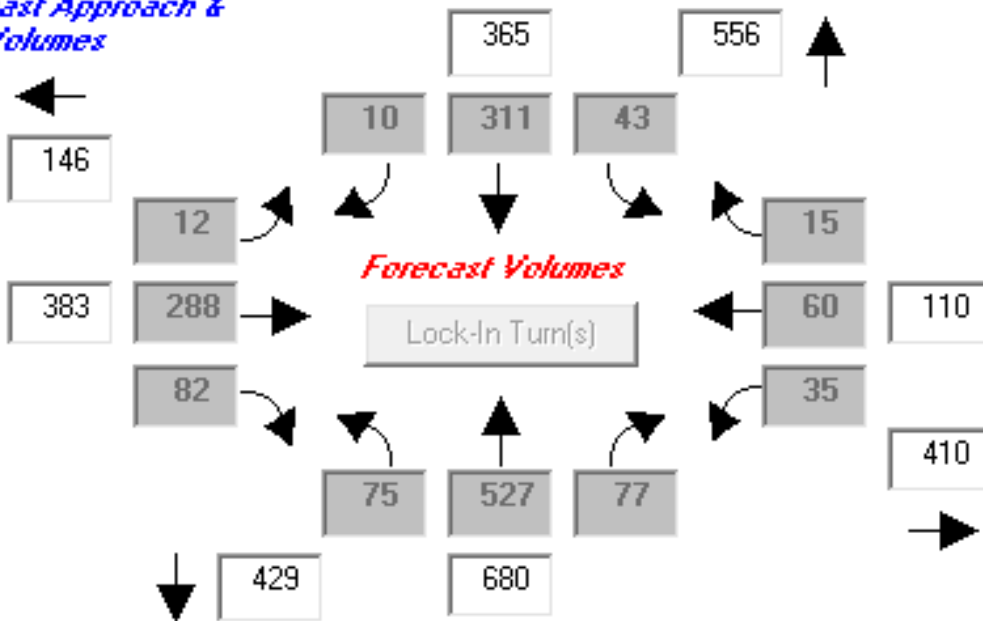

0 % Convergence

15 Iterations

Reset

Iterate

Print

Close

Enter Turning Counts

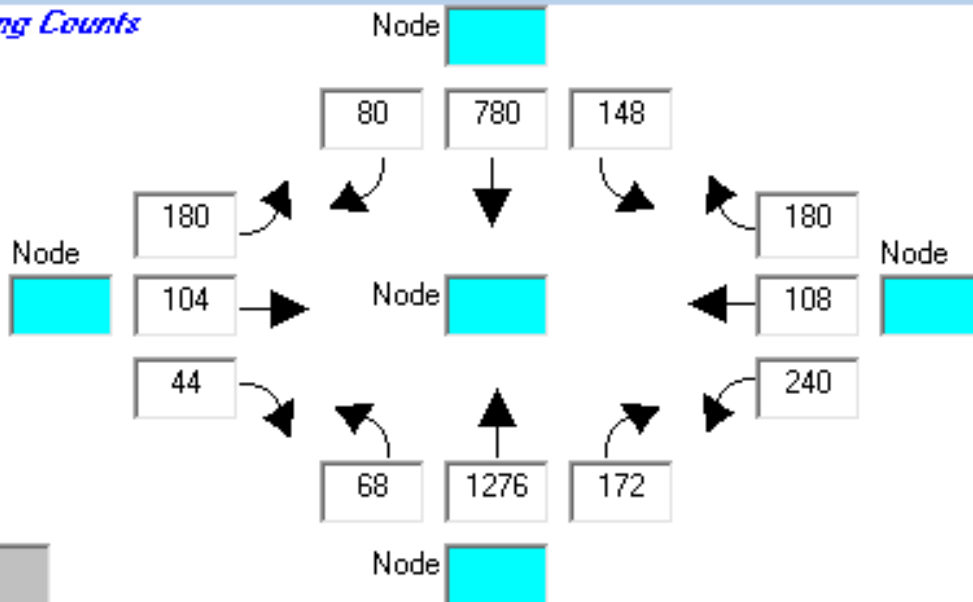

- Count data
- Turn %-ages

Previous

Next

1 of 1

Enter Forecast Approach & Departure Volumes

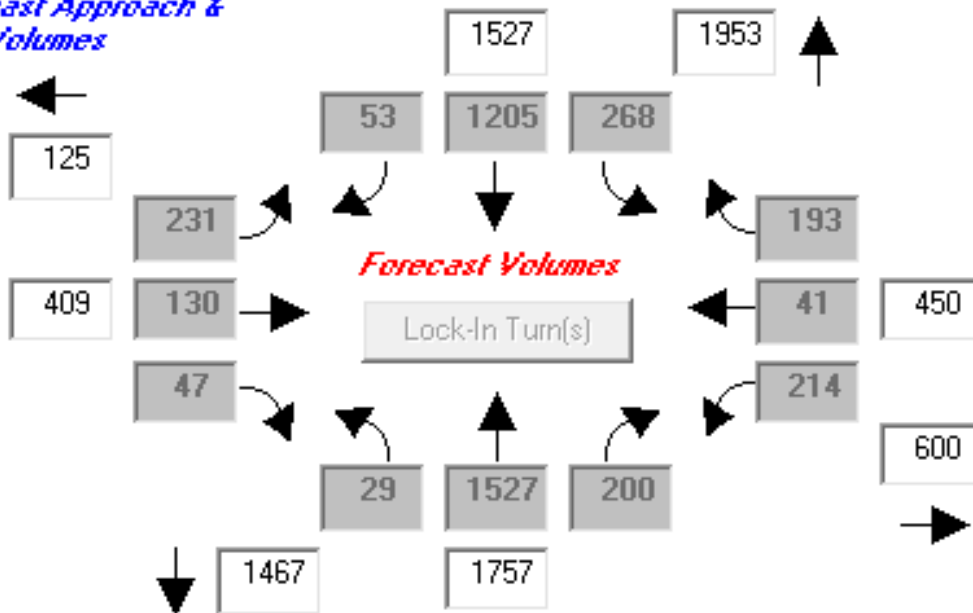

% Convergence

Iterations

Reset

Iterate

Print

Close

Enter Turning Counts

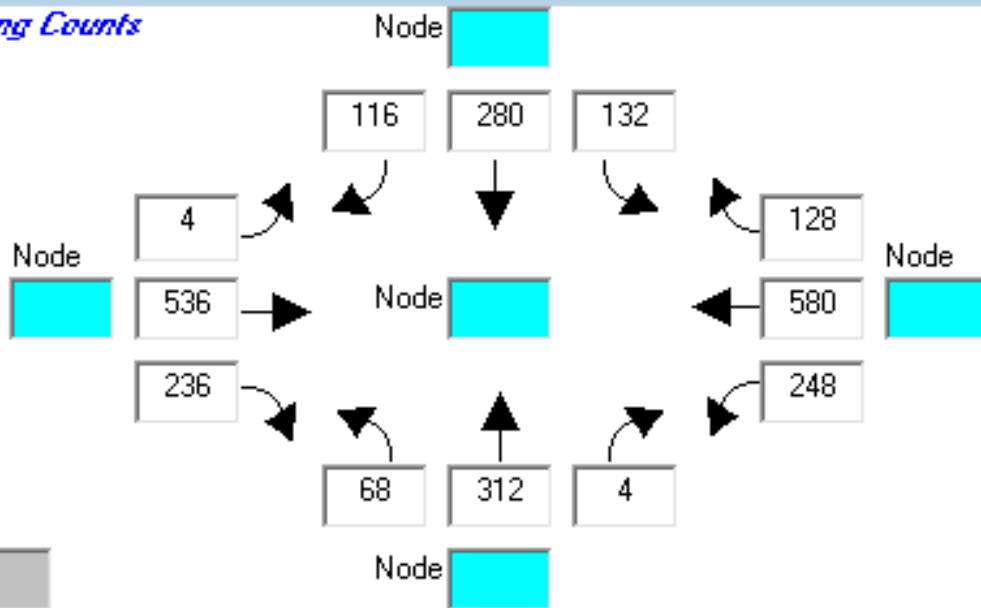

- Count data
- Turn %-ages

Previous
Next

1 of 1

Enter Forecast Approach & Departure Volumes

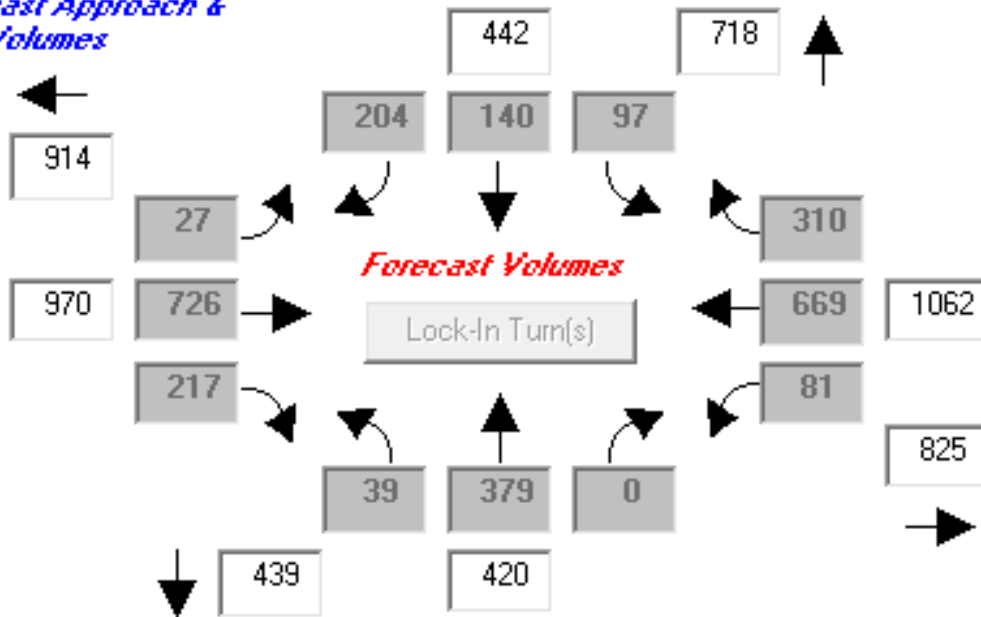

0 % Convergence
16 Iterations

Reset
Iterate
Print
Close

Enter Turning Counts

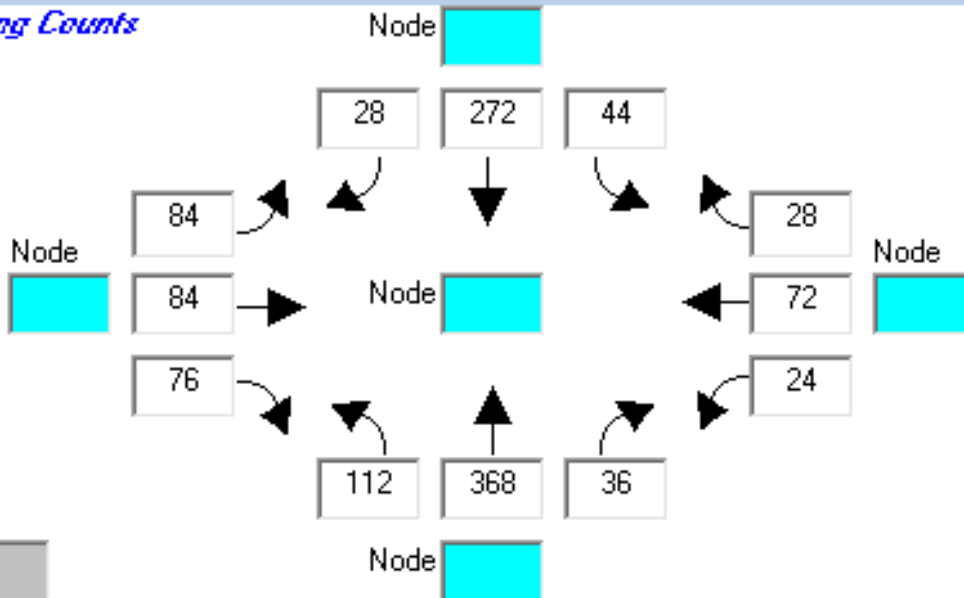

- Count data
- Turn %-ages

Previous
Next

1 of 1

Enter Forecast Approach & Departure Volumes

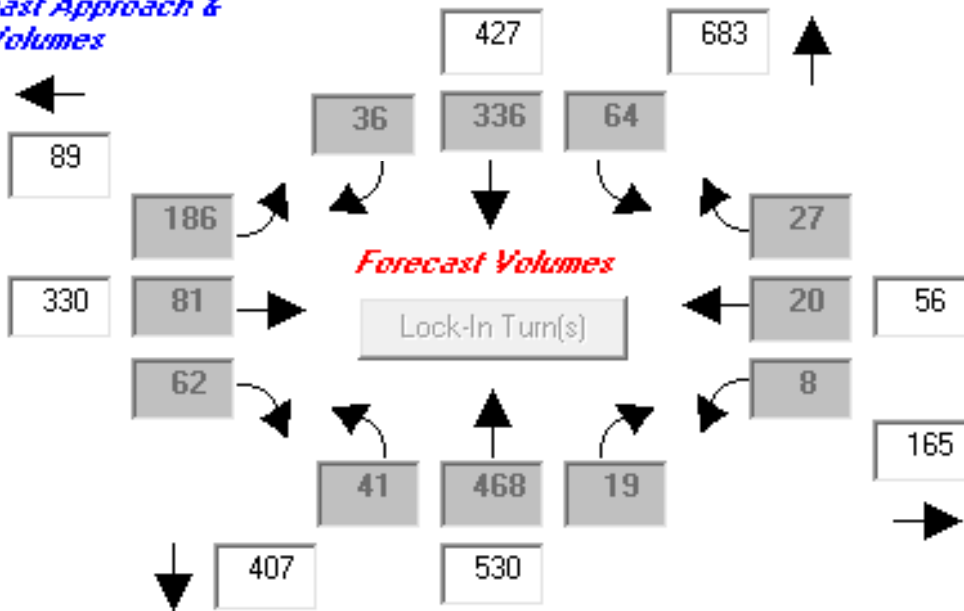

0 % Convergence
11 Iterations

Reset
Iterate
Print
Close



MEMORANDUM

TO: Hann Lee, H. Lee & Associates, PLLC
FROM: Shinwon Kim, Senior Transportation Planner
DATE: January 13, 2017
SUBJECT: Select Zone Assignment for TAZ 373

Enclosed are plots, showing auto volumes and OD flows during the PM Peak 1 hour for the year 2010 and 2035. TAZ 373 was selected for the assignments.

- 2010 Base Auto Volumes and OD Flows (2 plots)
- 2035 RTP Updates Auto Volumes and OD Flows (2 plots)
- TAZ Map
- Land Use

TAZ	2010 Base Land Use				2035 MTP Land Use			
	HH	Retail	Other	Total	HH	Retail	Other	Total
373	145	0	3	3	618	222	784	1006

* Note: HH: the number of households, Retail: retail employments, Other: other employments

An invoice will be sent to you under separate cover for 2-hour staff time and other cost.

If you have any questions, please let me know.

Enclosures:

cc: Patty Raedy, RTC

2010 PM Peak Auto Volumes

Link value: [auto volume] volau
0 links selected by: [road network] isAuto

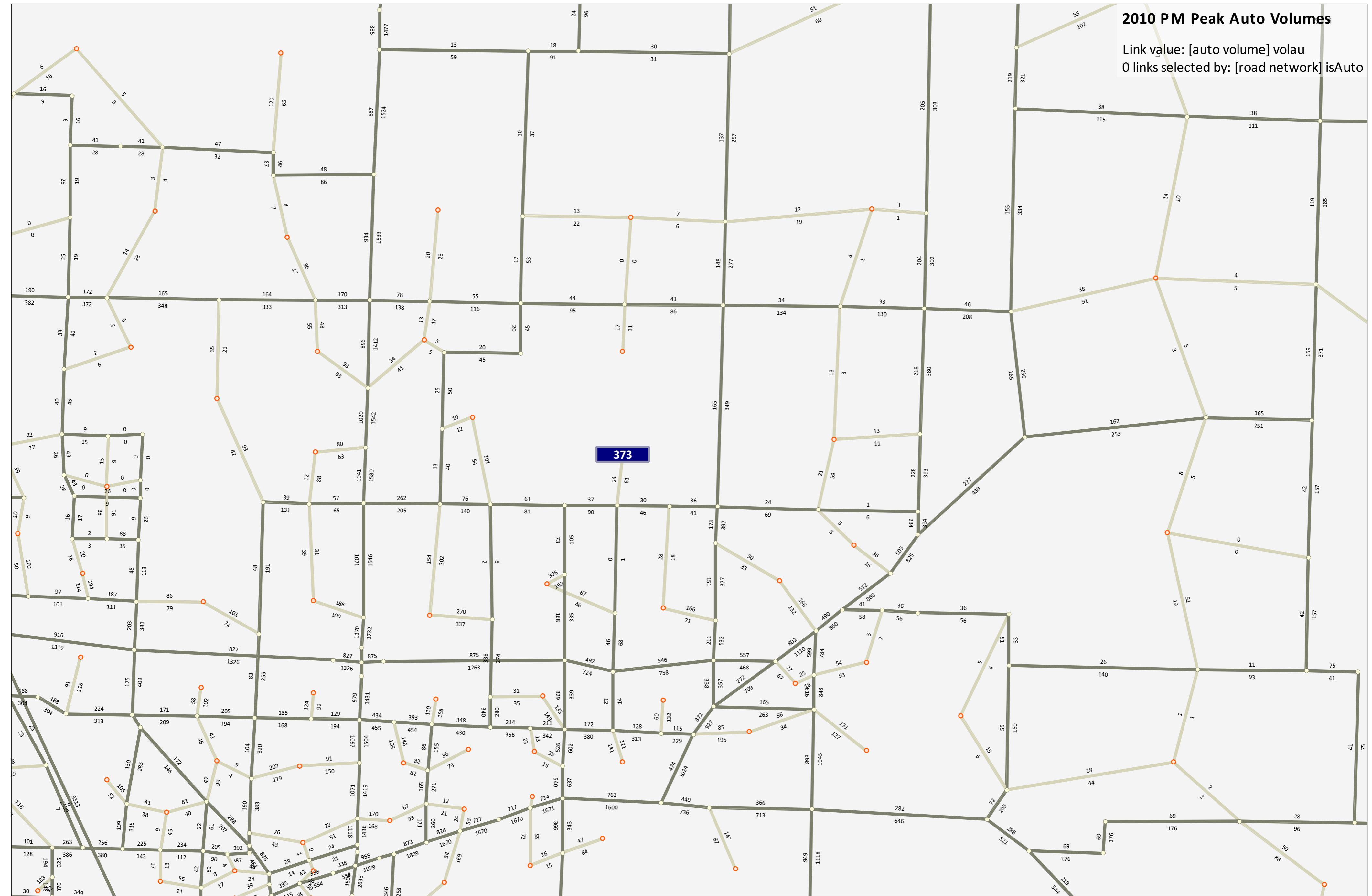

2035 PM Peak OD Flow for TAZ 373

select zone total vol

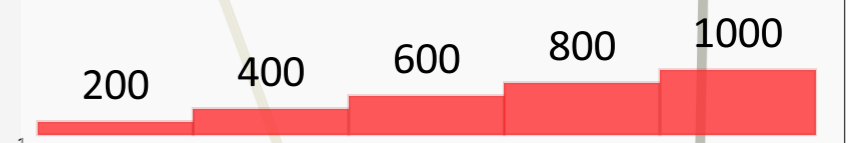

Scale: 50

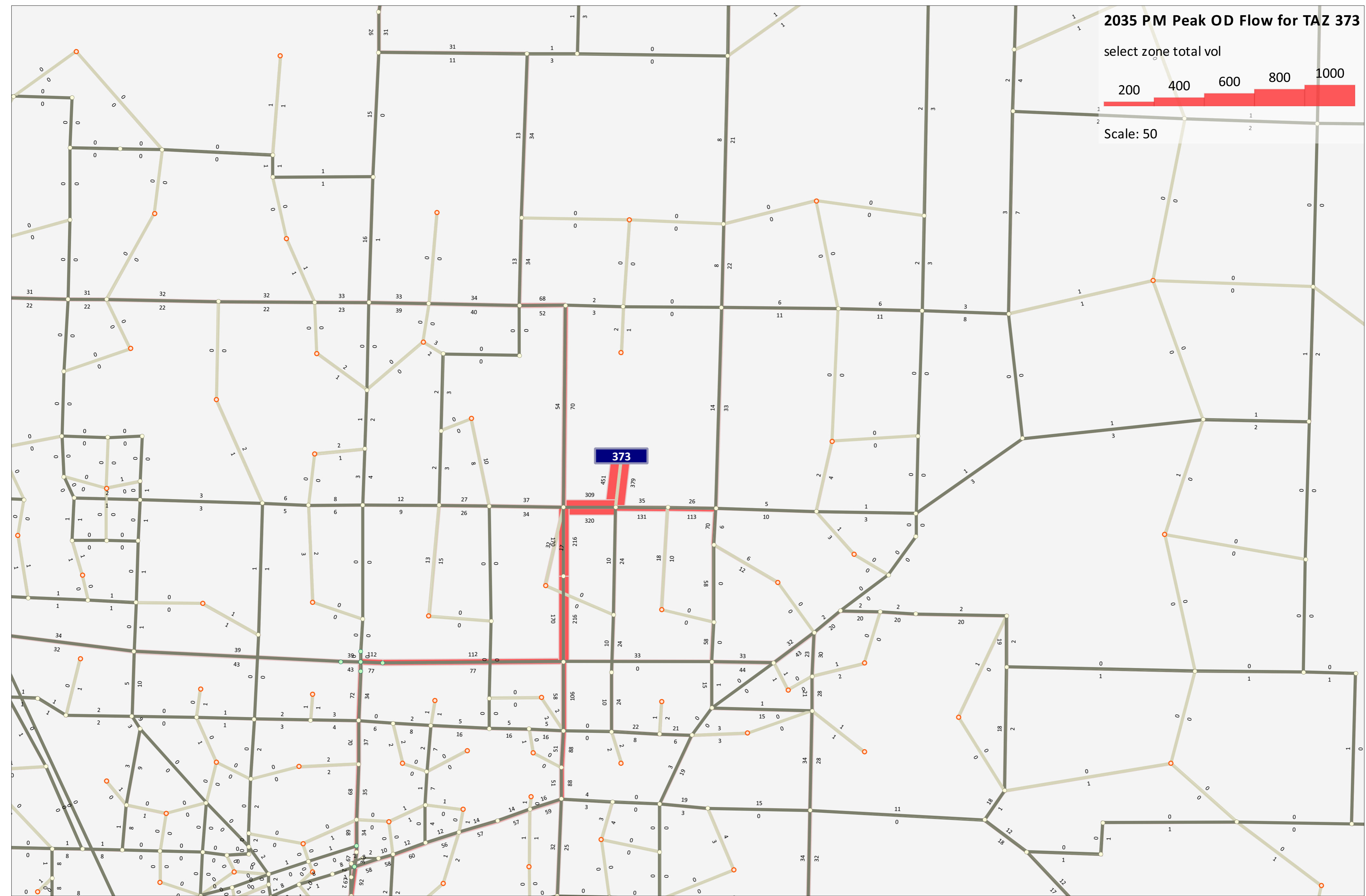

2035 PM Peak Auto Volumes

Link value: [auto volume] volau
0 links selected by: [road network] isAuto

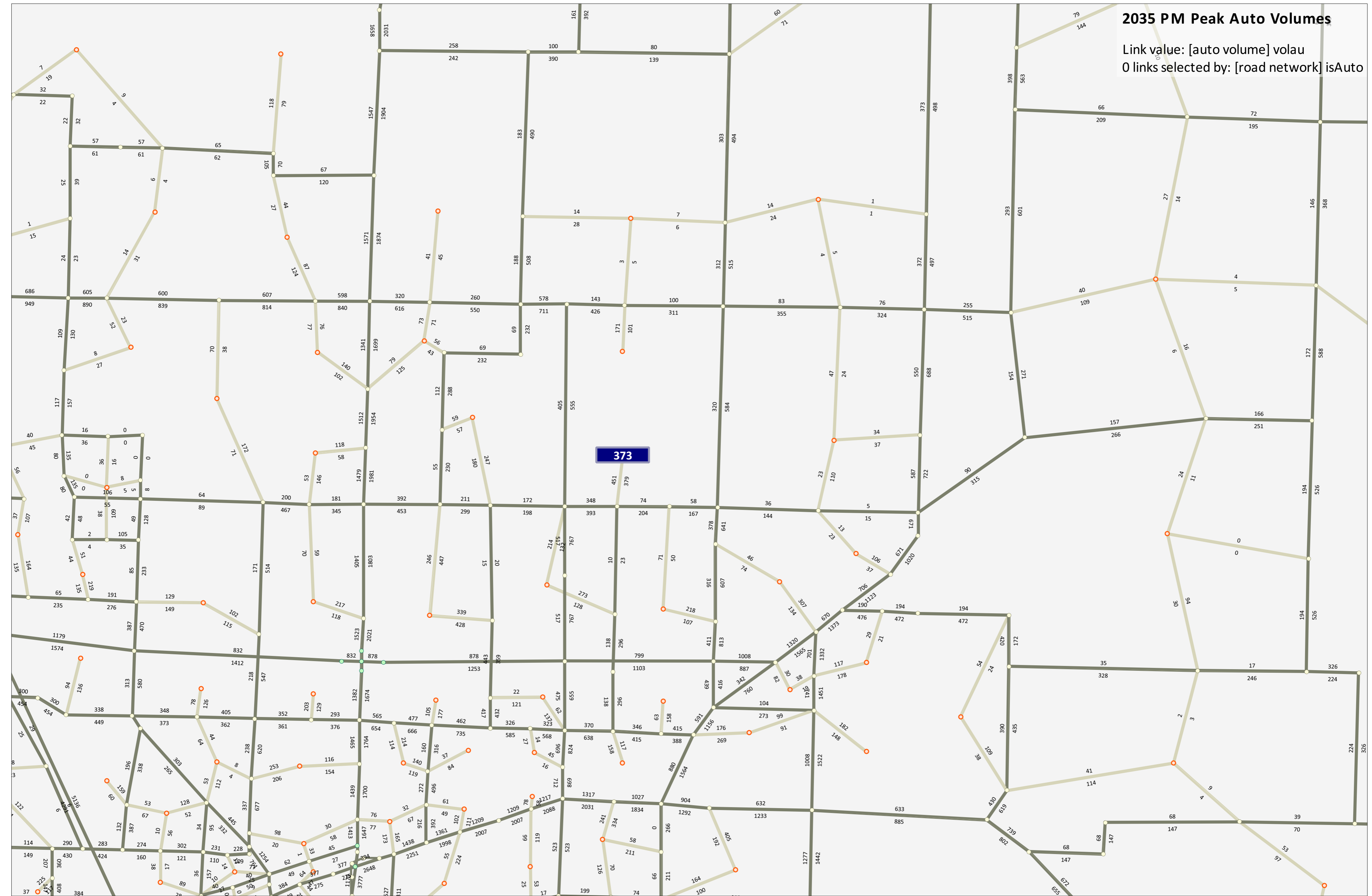

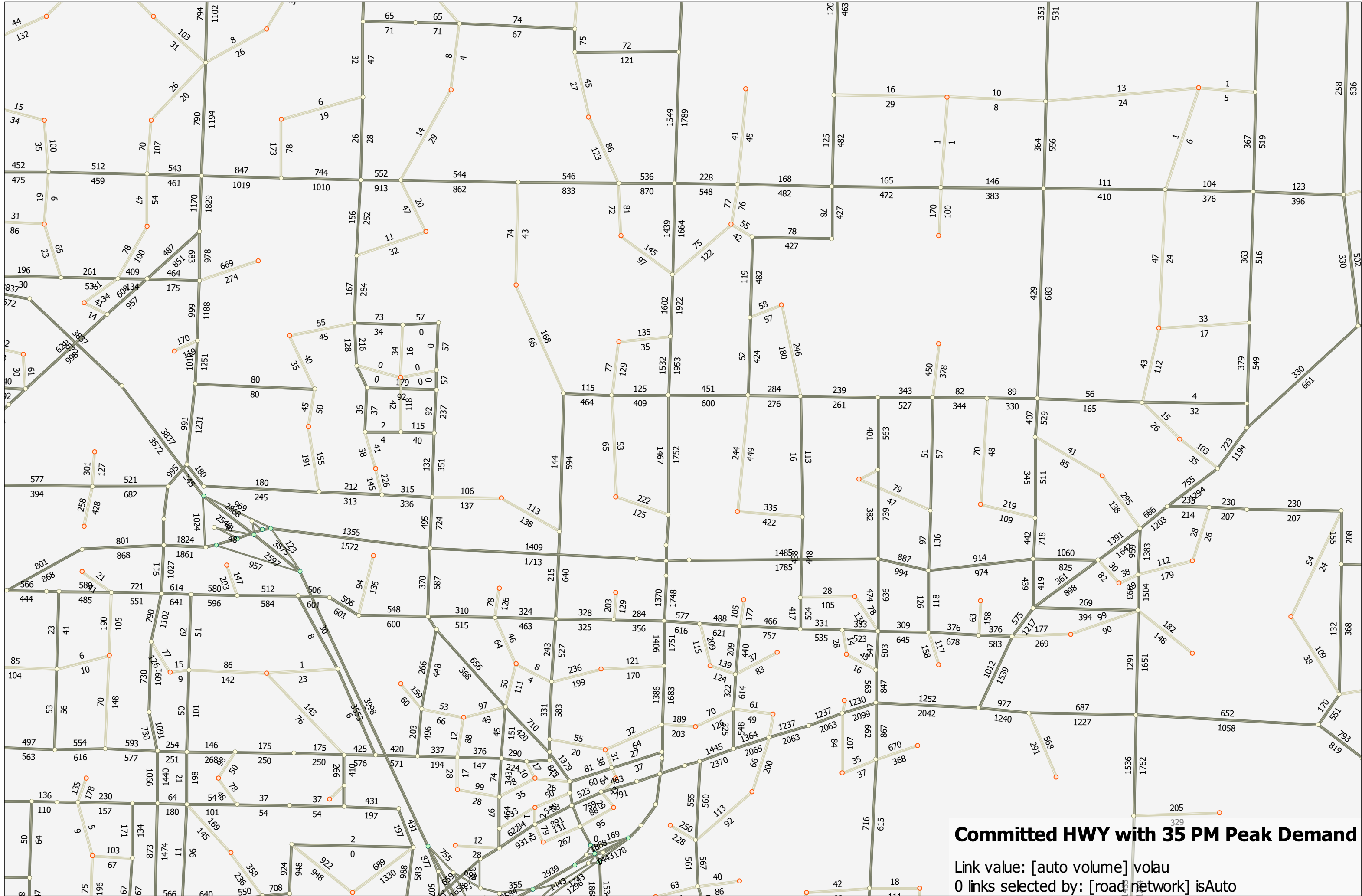

Committed HWY with 35 PM Peak Demand

Link value: [auto volume] volau
0 links selected by: [road:network] isAuto

2035 PM Peak OD Flow for TAZ 373

select zone total vol

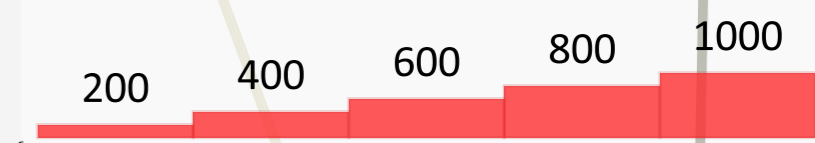

Scale: 50

373

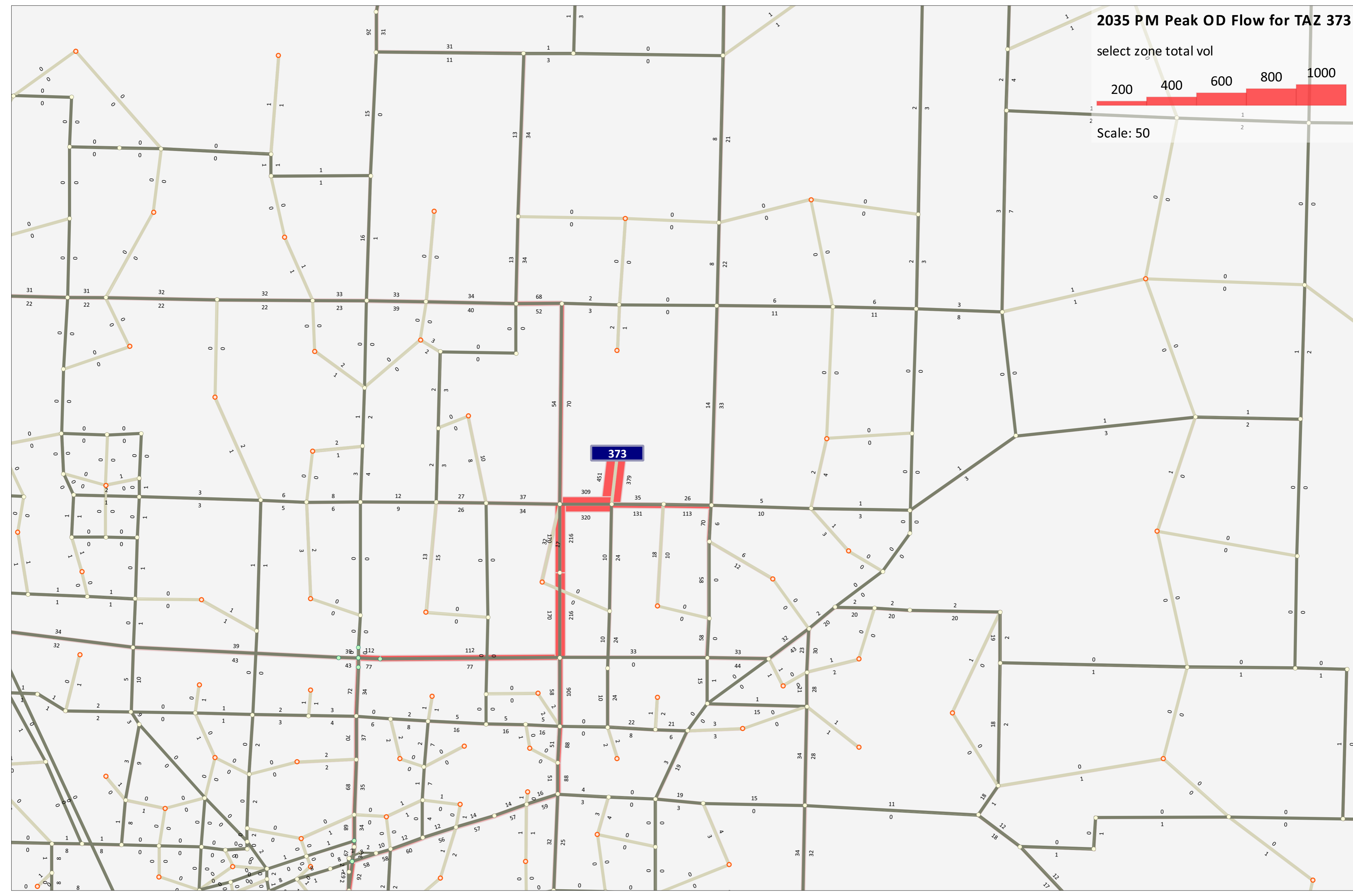

APPENDIX E

2039 “EXISTING ZONING BUILD OUT” LEVELS OF SERVICE

Lanes, Volumes, Timings
 1: NE 152nd Avenue & NE 119th Street

02/12/2019



Lane Group	EBL	EBT	EBR	WBL	WBT	WBR	NBL	NBT	NBR	SBL	SBT	SBR
Lane Configurations		↕			↕			↕			↕	
Traffic Volume (vph)	52	236	144	20	216	20	177	439	46	20	302	66
Future Volume (vph)	52	236	144	20	216	20	177	439	46	20	302	66
Ideal Flow (vphpl)	1900	1900	1900	1900	1900	1900	1900	1900	1900	1900	1900	1900
Lane Util. Factor	1.00	1.00	1.00	1.00	1.00	1.00	1.00	1.00	1.00	1.00	1.00	1.00
Frt		0.955			0.989			0.991			0.977	
Flt Protected		0.994			0.996			0.987			0.997	
Satd. Flow (prot)	0	1768	0	0	1782	0	0	1787	0	0	1851	0
Flt Permitted		0.941			0.960			0.802			0.960	
Satd. Flow (perm)	0	1674	0	0	1718	0	0	1452	0	0	1782	0
Right Turn on Red			Yes			Yes			Yes			Yes
Satd. Flow (RTOR)		44			8			9			26	
Link Speed (mph)		50			50			35			40	
Link Distance (ft)		2778			2259			4539			916	
Travel Time (s)		37.9			30.8			88.4			15.6	
Peak Hour Factor	1.00	1.00	1.00	1.00	1.00	1.00	1.00	1.00	1.00	1.00	1.00	1.00
Heavy Vehicles (%)	2%	2%	2%	5%	5%	5%	4%	4%	4%	0%	0%	0%
Adj. Flow (vph)	52	236	144	20	216	20	177	439	46	20	302	66
Shared Lane Traffic (%)												
Lane Group Flow (vph)	0	432	0	0	256	0	0	662	0	0	388	0
Enter Blocked Intersection	No	No	No	No	No	No	No	No	No	No	No	No
Lane Alignment	Left	Left	Right	Left	Left	Right	Left	Left	Right	Left	Left	Right
Median Width(ft)		0			0			0			0	
Link Offset(ft)		0			0			0			0	
Crosswalk Width(ft)		16			16			16			16	
Two way Left Turn Lane												
Headway Factor	1.00	1.00	1.00	1.00	1.00	1.00	1.00	1.00	1.00	1.00	1.00	1.00
Turning Speed (mph)	15		9	15		9	15		9	15		9
Number of Detectors	1	2		1	2		1	2		1	2	
Detector Template	Left	Thru		Left	Thru		Left	Thru		Left	Thru	
Leading Detector (ft)	20	100		20	100		20	100		20	100	
Trailing Detector (ft)	0	0		0	0		0	0		0	0	
Detector 1 Position(ft)	0	0		0	0		0	0		0	0	
Detector 1 Size(ft)	20	6		20	6		20	6		20	6	
Detector 1 Type	Cl+Ex	Cl+Ex		Cl+Ex	Cl+Ex		Cl+Ex	Cl+Ex		Cl+Ex	Cl+Ex	
Detector 1 Channel												
Detector 1 Extend (s)	0.0	0.0		0.0	0.0		0.0	0.0		0.0	0.0	
Detector 1 Queue (s)	0.0	0.0		0.0	0.0		0.0	0.0		0.0	0.0	
Detector 1 Delay (s)	0.0	0.0		0.0	0.0		0.0	0.0		0.0	0.0	
Detector 2 Position(ft)		94			94			94			94	
Detector 2 Size(ft)		6			6			6			6	
Detector 2 Type		Cl+Ex			Cl+Ex			Cl+Ex			Cl+Ex	
Detector 2 Channel												
Detector 2 Extend (s)		0.0			0.0			0.0			0.0	
Turn Type	Perm	NA		Perm	NA		Perm	NA		Perm	NA	
Protected Phases		4			8			2			6	
Permitted Phases	4			8			2			6		
Detector Phase	4	4		8	8		2	2		6	6	
Switch Phase												

Lanes, Volumes, Timings
 1: NE 152nd Avenue & NE 119th Street

02/12/2019



Lane Group	EBL	EBT	EBR	WBL	WBT	WBR	NBL	NBT	NBR	SBL	SBT	SBR
Minimum Initial (s)	5.0	5.0		5.0	5.0		5.0	5.0		5.0	5.0	
Minimum Split (s)	22.5	22.5		22.5	22.5		22.5	22.5		22.5	22.5	
Total Split (s)	24.0	24.0		24.0	24.0		36.0	36.0		36.0	36.0	
Total Split (%)	40.0%	40.0%		40.0%	40.0%		60.0%	60.0%		60.0%	60.0%	
Maximum Green (s)	19.5	19.5		19.5	19.5		31.5	31.5		31.5	31.5	
Yellow Time (s)	3.5	3.5		3.5	3.5		3.5	3.5		3.5	3.5	
All-Red Time (s)	1.0	1.0		1.0	1.0		1.0	1.0		1.0	1.0	
Lost Time Adjust (s)		0.0			0.0			0.0			0.0	
Total Lost Time (s)		4.5			4.5			4.5			4.5	
Lead/Lag												
Lead-Lag Optimize?												
Vehicle Extension (s)	3.0	3.0		3.0	3.0		3.0	3.0		3.0	3.0	
Recall Mode	None	None		None	None		Min	Min		Min	Min	
Walk Time (s)	7.0	7.0		7.0	7.0		7.0	7.0		7.0	7.0	
Flash Dont Walk (s)	11.0	11.0		11.0	11.0		11.0	11.0		11.0	11.0	
Pedestrian Calls (#/hr)	0	0		0	0		0	0		0	0	
Act Effect Green (s)		16.7			16.7			27.9			27.9	
Actuated g/C Ratio		0.31			0.31			0.52			0.52	
v/c Ratio		0.79			0.48			0.88			0.42	
Control Delay		28.4			18.8			27.8			9.4	
Queue Delay		0.0			0.0			0.0			0.0	
Total Delay		28.4			18.8			27.8			9.4	
LOS		C			B			C			A	
Approach Delay		28.4			18.8			27.8			9.4	
Approach LOS		C			B			C			A	

Intersection Summary

Area Type:	Other
Cycle Length:	60
Actuated Cycle Length:	53.9
Natural Cycle:	60
Control Type:	Actuated-Uncoordinated
Maximum v/c Ratio:	0.88
Intersection Signal Delay:	22.5
Intersection LOS:	C
Intersection Capacity Utilization:	104.0%
ICU Level of Service:	G
Analysis Period (min):	15

Splits and Phases: 1: NE 152nd Avenue & NE 119th Street

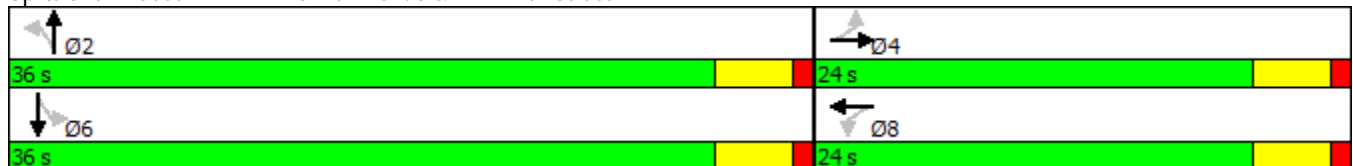

Queues

1: NE 152nd Avenue & NE 119th Street

02/12/2019

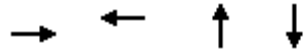

















Lane Group	EBT	WBT	NBT	SBT
Lane Group Flow (vph)	432	256	662	388
v/c Ratio	0.79	0.48	0.88	0.42
Control Delay	28.4	18.8	27.8	9.4
Queue Delay	0.0	0.0	0.0	0.0
Total Delay	28.4	18.8	27.8	9.4
Queue Length 50th (ft)	123	70	187	71
Queue Length 95th (ft)	#254	128	#397	125
Internal Link Dist (ft)	2698	2179	4459	836
Turn Bay Length (ft)				
Base Capacity (vph)	653	647	881	1087
Starvation Cap Reductn	0	0	0	0
Spillback Cap Reductn	0	0	0	0
Storage Cap Reductn	0	0	0	0
Reduced v/c Ratio	0.66	0.40	0.75	0.36

Intersection Summary

95th percentile volume exceeds capacity, queue may be longer.
 Queue shown is maximum after two cycles.

HCM 2010 Signalized Intersection Summary
 1: NE 152nd Avenue & NE 119th Street

02/12/2019

												
Movement	EBL	EBT	EBR	WBL	WBT	WBR	NBL	NBT	NBR	SBL	SBT	SBR
Lane Configurations												
Traffic Volume (veh/h)	52	236	144	20	216	20	177	439	46	20	302	66
Future Volume (veh/h)	52	236	144	20	216	20	177	439	46	20	302	66
Number	7	4	14	3	8	18	5	2	12	1	6	16
Initial Q (Qb), veh	0	0	0	0	0	0	0	0	0	0	0	0
Ped-Bike Adj(A_pbT)	1.00		1.00	1.00		1.00	1.00		1.00	1.00		1.00
Parking Bus, Adj	1.00	1.00	1.00	1.00	1.00	1.00	1.00	1.00	1.00	1.00	1.00	1.00
Adj Sat Flow, veh/h/ln	1900	1863	1900	1900	1810	1900	1900	1827	1900	1900	1900	1900
Adj Flow Rate, veh/h	52	236	144	20	216	20	177	439	46	20	302	66
Adj No. of Lanes	0	1	0	0	1	0	0	1	0	0	1	0
Peak Hour Factor	1.00	1.00	1.00	1.00	1.00	1.00	1.00	1.00	1.00	1.00	1.00	1.00
Percent Heavy Veh, %	2	2	2	5	5	5	4	4	4	0	0	0
Cap, veh/h	121	314	176	97	491	43	268	557	55	95	743	156
Arrive On Green	0.31	0.31	0.31	0.31	0.31	0.31	0.50	0.50	0.50	0.50	0.50	0.50
Sat Flow, veh/h	124	999	562	60	1562	137	349	1104	109	37	1475	310
Grp Volume(v), veh/h	432	0	0	256	0	0	662	0	0	388	0	0
Grp Sat Flow(s),veh/h/ln	1685	0	0	1760	0	0	1562	0	0	1821	0	0
Q Serve(g_s), s	5.8	0.0	0.0	0.0	0.0	0.0	10.8	0.0	0.0	0.0	0.0	0.0
Cycle Q Clear(g_c), s	11.6	0.0	0.0	5.7	0.0	0.0	17.3	0.0	0.0	6.5	0.0	0.0
Prop In Lane	0.12		0.33	0.08		0.08	0.27		0.07	0.05		0.17
Lane Grp Cap(c), veh/h	611	0	0	631	0	0	879	0	0	994	0	0
V/C Ratio(X)	0.71	0.00	0.00	0.41	0.00	0.00	0.75	0.00	0.00	0.39	0.00	0.00
Avail Cap(c_a), veh/h	741	0	0	765	0	0	1074	0	0	1226	0	0
HCM Platoon Ratio	1.00	1.00	1.00	1.00	1.00	1.00	1.00	1.00	1.00	1.00	1.00	1.00
Upstream Filter(I)	1.00	0.00	0.00	1.00	0.00	0.00	1.00	0.00	0.00	1.00	0.00	0.00
Uniform Delay (d), s/veh	15.5	0.0	0.0	13.6	0.0	0.0	10.0	0.0	0.0	7.7	0.0	0.0
Incr Delay (d2), s/veh	2.4	0.0	0.0	0.4	0.0	0.0	2.4	0.0	0.0	0.3	0.0	0.0
Initial Q Delay(d3),s/veh	0.0	0.0	0.0	0.0	0.0	0.0	0.0	0.0	0.0	0.0	0.0	0.0
%ile BackOfQ(50%),veh/ln	5.8	0.0	0.0	2.8	0.0	0.0	8.1	0.0	0.0	3.3	0.0	0.0
LnGrp Delay(d),s/veh	17.9	0.0	0.0	14.0	0.0	0.0	12.5	0.0	0.0	8.0	0.0	0.0
LnGrp LOS	B			B			B			A		
Approach Vol, veh/h		432			256			662				388
Approach Delay, s/veh		17.9			14.0			12.5				8.0
Approach LOS		B			B			B				A
Timer	1	2	3	4	5	6	7	8				
Assigned Phs		2		4		6		8				
Phs Duration (G+Y+Rc), s		29.5		20.1		29.5		20.1				
Change Period (Y+Rc), s		4.5		4.5		4.5		4.5				
Max Green Setting (Gmax), s		31.5		19.5		31.5		19.5				
Max Q Clear Time (g_c+l1), s		19.3		13.6		8.5		7.7				
Green Ext Time (p_c), s		5.6		2.0		7.8		3.1				
Intersection Summary												
HCM 2010 Ctrl Delay				13.0								
HCM 2010 LOS				B								

Lanes, Volumes, Timings
 2: NE 117th Avenue (SR 503) & NE 99th Street

02/12/2019

Lane Group	EBL	EBT	EBR	WBL	WBT	WBR	NBL	NBT	NBR	SBL	SBT	SBR
Lane Configurations												
Traffic Volume (vph)	250	141	51	232	44	209	31	1653	216	290	1304	57
Future Volume (vph)	250	141	51	232	44	209	31	1653	216	290	1304	57
Ideal Flow (vphpl)	1900	1900	1900	1900	1900	1900	1900	1900	1900	1900	1900	1900
Storage Length (ft)	300		215	300		230	580		315	460		250
Storage Lanes	1		1	1		1	1		1	1		1
Taper Length (ft)	25			25			25			25		
Lane Util. Factor	1.00	1.00	1.00	1.00	1.00	1.00	1.00	0.95	1.00	1.00	0.95	1.00
Frt			0.850			0.850			0.850			0.850
Flt Protected	0.950			0.950			0.950			0.950		
Satd. Flow (prot)	1736	1827	1553	1787	1881	1599	1770	3539	1583	1736	3471	1553
Flt Permitted	0.581			0.605			0.175			0.063		
Satd. Flow (perm)	1061	1827	1553	1138	1881	1599	326	3539	1583	115	3471	1553
Right Turn on Red			Yes			Yes			Yes			Yes
Satd. Flow (RTOR)			95			55			216			57
Link Speed (mph)		30			35			40			40	
Link Distance (ft)		952			8013			3477			3940	
Travel Time (s)		21.6			156.1			59.3			67.2	
Peak Hour Factor	1.00	1.00	1.00	1.00	1.00	1.00	1.00	1.00	1.00	1.00	1.00	1.00
Heavy Vehicles (%)	4%	4%	4%	1%	1%	1%	2%	2%	2%	4%	4%	4%
Adj. Flow (vph)	250	141	51	232	44	209	31	1653	216	290	1304	57
Shared Lane Traffic (%)												
Lane Group Flow (vph)	250	141	51	232	44	209	31	1653	216	290	1304	57
Enter Blocked Intersection	No	No	No	No	No	No	No	No	No	No	No	No
Lane Alignment	Left	Left	Right	Left	Left	Right	Left	Left	Right	Left	Left	Right
Median Width(ft)		12			12			12			12	
Link Offset(ft)		0			0			0			0	
Crosswalk Width(ft)		16			16			16			16	
Two way Left Turn Lane												
Headway Factor	1.00	1.00	1.00	1.00	1.00	1.00	1.00	1.00	1.00	1.00	1.00	1.00
Turning Speed (mph)	15		9	15		9	15		9	15		9
Number of Detectors	1	2	1	1	2	1	1	2	1	1	2	1
Detector Template	Left	Thru	Right	Left	Thru	Right	Left	Thru	Right	Left	Thru	Right
Leading Detector (ft)	20	100	20	20	100	20	20	100	20	20	100	20
Trailing Detector (ft)	0	0	0	0	0	0	0	0	0	0	0	0
Detector 1 Position(ft)	0	0	0	0	0	0	0	0	0	0	0	0
Detector 1 Size(ft)	20	6	20	20	6	20	20	6	20	20	6	20
Detector 1 Type	Cl+Ex	Cl+Ex	Cl+Ex	Cl+Ex	Cl+Ex	Cl+Ex	Cl+Ex	Cl+Ex	Cl+Ex	Cl+Ex	Cl+Ex	Cl+Ex
Detector 1 Channel												
Detector 1 Extend (s)	0.0	0.0	0.0	0.0	0.0	0.0	0.0	0.0	0.0	0.0	0.0	0.0
Detector 1 Queue (s)	0.0	0.0	0.0	0.0	0.0	0.0	0.0	0.0	0.0	0.0	0.0	0.0
Detector 1 Delay (s)	0.0	0.0	0.0	0.0	0.0	0.0	0.0	0.0	0.0	0.0	0.0	0.0
Detector 2 Position(ft)		94			94			94			94	
Detector 2 Size(ft)		6			6			6			6	
Detector 2 Type		Cl+Ex			Cl+Ex			Cl+Ex			Cl+Ex	
Detector 2 Channel												
Detector 2 Extend (s)		0.0			0.0			0.0			0.0	
Turn Type	pm+pt	NA	pm+ov	pm+pt	NA	pm+ov	pm+pt	NA	pm+ov	pm+pt	NA	pm+ov
Protected Phases	7	4	5	3	8	1	5	2	3	1	6	7

Lanes, Volumes, Timings
 2: NE 117th Avenue (SR 503) & NE 99th Street

02/12/2019



Lane Group	EBL	EBT	EBR	WBL	WBT	WBR	NBL	NBT	NBR	SBL	SBT	SBR
Permitted Phases	4		4	8		8	2		2	6		6
Detector Phase	7	4	5	3	8	1	5	2	3	1	6	7
Switch Phase												
Minimum Initial (s)	5.0	5.0	5.0	5.0	5.0	5.0	5.0	5.0	5.0	5.0	5.0	5.0
Minimum Split (s)	9.5	22.5	9.5	9.5	22.5	9.5	9.5	22.5	9.5	9.5	22.5	9.5
Total Split (s)	12.2	22.5	9.6	12.2	22.5	21.2	9.6	64.1	12.2	21.2	75.7	12.2
Total Split (%)	10.2%	18.8%	8.0%	10.2%	18.8%	17.7%	8.0%	53.4%	10.2%	17.7%	63.1%	10.2%
Maximum Green (s)	7.7	18.0	5.1	7.7	18.0	16.7	5.1	59.6	7.7	16.7	71.2	7.7
Yellow Time (s)	3.5	3.5	3.5	3.5	3.5	3.5	3.5	3.5	3.5	3.5	3.5	3.5
All-Red Time (s)	1.0	1.0	1.0	1.0	1.0	1.0	1.0	1.0	1.0	1.0	1.0	1.0
Lost Time Adjust (s)	0.0	0.0	0.0	0.0	0.0	0.0	0.0	0.0	0.0	0.0	0.0	0.0
Total Lost Time (s)	4.5	4.5	4.5	4.5	4.5	4.5	4.5	4.5	4.5	4.5	4.5	4.5
Lead/Lag	Lead	Lag	Lead	Lead	Lag	Lead	Lead	Lag	Lead	Lead	Lag	Lead
Lead-Lag Optimize?	Yes	Yes	Yes	Yes	Yes	Yes	Yes	Yes	Yes	Yes	Yes	Yes
Vehicle Extension (s)	3.0	3.0	3.0	3.0	3.0	3.0	3.0	3.0	3.0	3.0	3.0	3.0
Recall Mode	None	None	None	None	None	None	None	Min	None	None	Min	None
Walk Time (s)		7.0			7.0			7.0			7.0	
Flash Dont Walk (s)		11.0			11.0			11.0			11.0	
Pedestrian Calls (#/hr)		0			0			0			0	
Act Effct Green (s)	22.5	13.7	23.4	19.5	13.0	32.0	62.7	57.6	69.9	78.9	71.4	87.7
Actuated g/C Ratio	0.20	0.12	0.21	0.17	0.11	0.28	0.55	0.51	0.61	0.69	0.63	0.77
v/c Ratio	0.92	0.64	0.13	0.97	0.21	0.43	0.13	0.92	0.20	0.91	0.60	0.05
Control Delay	81.3	61.9	1.5	95.9	47.8	26.2	8.5	36.4	1.8	66.0	15.0	1.6
Queue Delay	0.0	0.0	0.0	0.0	0.0	0.0	0.0	0.0	0.0	0.0	0.0	0.0
Total Delay	81.3	61.9	1.5	95.9	47.8	26.2	8.5	36.4	1.8	66.0	15.0	1.6
LOS	F	E	A	F	D	C	A	D	A	E	B	A
Approach Delay		65.9			61.5			32.0			23.5	
Approach LOS		E			E			C			C	

Intersection Summary

Area Type: Other
 Cycle Length: 120
 Actuated Cycle Length: 113.9
 Natural Cycle: 110
 Control Type: Actuated-Uncoordinated
 Maximum v/c Ratio: 0.97
 Intersection Signal Delay: 35.4
 Intersection LOS: D
 Intersection Capacity Utilization 97.0%
 ICU Level of Service F
 Analysis Period (min) 15

Splits and Phases: 2: NE 117th Avenue (SR 503) & NE 99th Street

21.2 s	64.1 s	12.2 s	22.5 s
9.6 s	75.7 s	12.2 s	22.5 s

Queues

2: NE 117th Avenue (SR 503) & NE 99th Street

02/12/2019

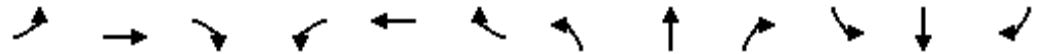

























Lane Group	EBL	EBT	EBR	WBL	WBT	WBR	NBL	NBT	NBR	SBL	SBT	SBR
Lane Group Flow (vph)	250	141	51	232	44	209	31	1653	216	290	1304	57
v/c Ratio	0.92	0.64	0.13	0.97	0.21	0.43	0.13	0.92	0.20	0.91	0.60	0.05
Control Delay	81.3	61.9	1.5	95.9	47.8	26.2	8.5	36.4	1.8	66.0	15.0	1.6
Queue Delay	0.0	0.0	0.0	0.0	0.0	0.0	0.0	0.0	0.0	0.0	0.0	0.0
Total Delay	81.3	61.9	1.5	95.9	47.8	26.2	8.5	36.4	1.8	66.0	15.0	1.6
Queue Length 50th (ft)	~175	102	0	155	30	89	6	574	0	165	297	0
Queue Length 95th (ft)	#338	169	5	#282	66	158	18	#795	30	#350	397	12
Internal Link Dist (ft)		872			7933			3397			3860	
Turn Bay Length (ft)	300		215	300		230	580		315	460		250
Base Capacity (vph)	272	289	394	238	298	489	244	1858	1054	317	2177	1208
Starvation Cap Reductn	0	0	0	0	0	0	0	0	0	0	0	0
Spillback Cap Reductn	0	0	0	0	0	0	0	0	0	0	0	0
Storage Cap Reductn	0	0	0	0	0	0	0	0	0	0	0	0
Reduced v/c Ratio	0.92	0.49	0.13	0.97	0.15	0.43	0.13	0.89	0.20	0.91	0.60	0.05

Intersection Summary

- ~ Volume exceeds capacity, queue is theoretically infinite.
Queue shown is maximum after two cycles.
- # 95th percentile volume exceeds capacity, queue may be longer.
Queue shown is maximum after two cycles.

HCM 2010 Signalized Intersection Summary
 2: NE 117th Avenue (SR 503) & NE 99th Street

02/12/2019

												
Movement	EBL	EBT	EBR	WBL	WBT	WBR	NBL	NBT	NBR	SBL	SBT	SBR
Lane Configurations												
Traffic Volume (veh/h)	250	141	51	232	44	209	31	1653	216	290	1304	57
Future Volume (veh/h)	250	141	51	232	44	209	31	1653	216	290	1304	57
Number	7	4	14	3	8	18	5	2	12	1	6	16
Initial Q (Qb), veh	0	0	0	0	0	0	0	0	0	0	0	0
Ped-Bike Adj(A_pbT)	1.00		1.00	1.00		1.00	1.00		1.00	1.00		1.00
Parking Bus, Adj	1.00	1.00	1.00	1.00	1.00	1.00	1.00	1.00	1.00	1.00	1.00	1.00
Adj Sat Flow, veh/h/ln	1827	1827	1827	1881	1881	1881	1863	1863	1863	1827	1827	1827
Adj Flow Rate, veh/h	250	141	51	232	44	209	31	1653	216	290	1304	57
Adj No. of Lanes	1	1	1	1	1	1	1	2	1	1	2	1
Peak Hour Factor	1.00	1.00	1.00	1.00	1.00	1.00	1.00	1.00	1.00	1.00	1.00	1.00
Percent Heavy Veh, %	4	4	4	1	1	1	2	2	2	4	4	4
Cap, veh/h	301	243	249	254	250	428	265	1805	913	316	2145	1063
Arrive On Green	0.07	0.13	0.13	0.07	0.13	0.13	0.03	0.51	0.51	0.14	0.62	0.62
Sat Flow, veh/h	1740	1827	1553	1792	1881	1599	1774	3539	1583	1740	3471	1553
Grp Volume(v), veh/h	250	141	51	232	44	209	31	1653	216	290	1304	57
Grp Sat Flow(s),veh/h/ln	1740	1827	1553	1792	1881	1599	1774	1770	1583	1740	1736	1553
Q Serve(g_s), s	7.7	8.4	3.3	7.7	2.4	12.7	1.0	49.7	7.7	13.5	26.6	1.4
Cycle Q Clear(g_c), s	7.7	8.4	3.3	7.7	2.4	12.7	1.0	49.7	7.7	13.5	26.6	1.4
Prop In Lane	1.00		1.00	1.00		1.00	1.00		1.00	1.00		1.00
Lane Grp Cap(c), veh/h	301	243	249	254	250	428	265	1805	913	316	2145	1063
V/C Ratio(X)	0.83	0.58	0.21	0.91	0.18	0.49	0.12	0.92	0.24	0.92	0.61	0.05
Avail Cap(c_a), veh/h	301	284	284	254	293	465	295	1823	921	333	2145	1063
HCM Platoon Ratio	1.00	1.00	1.00	1.00	1.00	1.00	1.00	1.00	1.00	1.00	1.00	1.00
Upstream Filter(I)	1.00	1.00	1.00	1.00	1.00	1.00	1.00	1.00	1.00	1.00	1.00	1.00
Uniform Delay (d), s/veh	45.8	47.1	42.2	46.9	44.6	35.7	13.5	26.1	12.0	35.9	13.5	6.0
Incr Delay (d2), s/veh	17.4	2.2	0.4	34.6	0.3	0.9	0.2	7.7	0.1	28.4	0.5	0.0
Initial Q Delay(d3),s/veh	0.0	0.0	0.0	0.0	0.0	0.0	0.0	0.0	0.0	0.0	0.0	0.0
%ile BackOfQ(50%),veh/ln	5.7	4.4	1.4	6.0	1.3	5.7	0.5	26.0	3.4	11.6	12.8	0.6
LnGrp Delay(d),s/veh	63.1	49.3	42.6	81.5	44.9	36.5	13.7	33.8	12.1	64.3	14.0	6.0
LnGrp LOS	E	D	D	F	D	D	B	C	B	E	B	A
Approach Vol, veh/h		442			485			1900			1651	
Approach Delay, s/veh		56.4			58.8			31.0			22.6	
Approach LOS		E			E			C			C	
Timer	1	2	3	4	5	6	7	8				
Assigned Phs	1	2	3	4	5	6	7	8				
Phs Duration (G+Y+Rc), s	20.1	63.5	12.2	19.9	7.7	76.0	12.2	19.9				
Change Period (Y+Rc), s	4.5	4.5	4.5	4.5	4.5	4.5	4.5	4.5				
Max Green Setting (Gmax), s	16.7	59.6	7.7	18.0	5.1	71.2	7.7	18.0				
Max Q Clear Time (g_c+I1), s	15.5	51.7	9.7	10.4	3.0	28.6	9.7	14.7				
Green Ext Time (p_c), s	0.1	7.3	0.0	1.2	0.0	35.3	0.0	0.6				
Intersection Summary												
HCM 2010 Ctrl Delay			33.4									
HCM 2010 LOS			C									

Lanes, Volumes, Timings
 3: NE 152nd Avenue & NE Padden Parkway

02/13/2019



Lane Group	EBL	EBT	EBR	WBL	WBT	WBR	NBL	NBT	NBR	SBL	SBT	SBR
Lane Configurations												
Traffic Volume (vph)	29	786	235	88	724	336	42	410	0	105	152	221
Future Volume (vph)	29	786	235	88	724	336	42	410	0	105	152	221
Ideal Flow (vphpl)	1900	1900	1900	1900	1900	1900	1900	1900	1900	1900	1900	1900
Storage Length (ft)	330		0	215		125	205		0	315		100
Storage Lanes	1		1	1		1	1		0	1		1
Taper Length (ft)	25			25			25			25		
Lane Util. Factor	1.00	1.00	1.00	1.00	1.00	1.00	1.00	1.00	1.00	1.00	1.00	1.00
Frt			0.850			0.850						0.850
Flt Protected	0.950			0.950			0.950			0.950		
Satd. Flow (prot)	1787	1881	1599	1787	1881	1599	1805	1900	0	1770	1863	1583
Flt Permitted	0.950			0.950			0.574			0.184		
Satd. Flow (perm)	1787	1881	1599	1787	1881	1599	1091	1900	0	343	1863	1583
Right Turn on Red			Yes			Yes			Yes			Yes
Satd. Flow (RTOR)			235			213						208
Link Speed (mph)		50			50			35				35
Link Distance (ft)		1502			1580			896				3406
Travel Time (s)		20.5			21.5			17.5				66.4
Peak Hour Factor	1.00	1.00	1.00	1.00	1.00	1.00	1.00	1.00	1.00	1.00	1.00	1.00
Heavy Vehicles (%)	1%	1%	1%	1%	1%	1%	0%	0%	0%	2%	2%	2%
Adj. Flow (vph)	29	786	235	88	724	336	42	410	0	105	152	221
Shared Lane Traffic (%)												
Lane Group Flow (vph)	29	786	235	88	724	336	42	410	0	105	152	221
Enter Blocked Intersection	No	No	No	No	No	No	No	No	No	No	No	No
Lane Alignment	Left	Left	Right	Left	Left	Right	Left	Left	Right	Left	Left	Right
Median Width(ft)		12			12			12				12
Link Offset(ft)		0			0			0				0
Crosswalk Width(ft)		16			16			16				16
Two way Left Turn Lane												
Headway Factor	1.00	1.00	1.00	1.00	1.00	1.00	1.00	1.00	1.00	1.00	1.00	1.00
Turning Speed (mph)	15		9	15		9	15		9	15		9
Turn Type	Prot	NA	pm+ov	Prot	NA	pm+ov	pm+pt	NA		pm+pt	NA	pm+ov
Protected Phases	7	4	5	3	8	1	5	2		1	6	7
Permitted Phases			4			8	2			6		6
Minimum Split (s)	9.5	22.5	9.5	9.5	22.5	9.5	9.5	22.5		9.5	22.5	9.5
Total Split (s)	9.6	43.0	11.0	9.8	43.2	9.8	11.0	27.4		9.8	26.2	9.6
Total Split (%)	10.7%	47.8%	12.2%	10.9%	48.0%	10.9%	12.2%	30.4%		10.9%	29.1%	10.7%
Maximum Green (s)	5.1	38.5	6.5	5.3	38.7	5.3	6.5	22.9		5.3	21.7	5.1
Yellow Time (s)	3.5	3.5	3.5	3.5	3.5	3.5	3.5	3.5		3.5	3.5	3.5
All-Red Time (s)	1.0	1.0	1.0	1.0	1.0	1.0	1.0	1.0		1.0	1.0	1.0
Lost Time Adjust (s)	0.0	0.0	0.0	0.0	0.0	0.0	0.0	0.0		0.0	0.0	0.0
Total Lost Time (s)	4.5	4.5	4.5	4.5	4.5	4.5	4.5	4.5		4.5	4.5	4.5
Lead/Lag	Lead	Lag	Lead	Lead	Lag	Lead	Lead	Lag		Lead	Lag	Lead
Lead-Lag Optimize?	Yes	Yes	Yes	Yes	Yes	Yes	Yes	Yes		Yes	Yes	Yes
Walk Time (s)		7.0			7.0			7.0				7.0
Flash Dont Walk (s)		11.0			11.0			11.0				11.0
Pedestrian Calls (#/hr)		0			0			0				0
Act Effct Green (s)	5.1	38.5	49.5	5.3	38.7	48.5	29.4	22.9		27.0	21.7	31.3
Actuated g/C Ratio	0.06	0.43	0.55	0.06	0.43	0.54	0.33	0.25		0.30	0.24	0.35

Lanes, Volumes, Timings
 3: NE 152nd Avenue & NE Padden Parkway

02/13/2019



Lane Group	EBL	EBT	EBR	WBL	WBT	WBR	NBL	NBT	NBR	SBL	SBT	SBR
v/c Ratio	0.29	0.98	0.24	0.84	0.90	0.35	0.10	0.85		0.56	0.34	0.32
Control Delay	48.3	53.8	2.0	96.8	39.8	5.3	19.5	50.0		32.9	30.8	5.2
Queue Delay	0.0	0.0	0.0	0.0	0.0	0.0	0.0	0.0		0.0	0.0	0.0
Total Delay	48.3	53.8	2.0	96.8	39.8	5.3	19.5	50.0		32.9	30.8	5.2
LOS	D	D	A	F	D	A	B	D		C	C	A
Approach Delay		42.0			34.1			47.2			19.4	
Approach LOS		D			C			D			B	

Intersection Summary

Area Type: Other
 Cycle Length: 90
 Actuated Cycle Length: 90
 Offset: 0 (0%), Referenced to phase 2:NBTL and 6:SBTL, Start of Green
 Natural Cycle: 90
 Control Type: Pretimed
 Maximum v/c Ratio: 0.98
 Intersection Signal Delay: 36.4
 Intersection LOS: D
 Intersection Capacity Utilization 88.6%
 ICU Level of Service E
 Analysis Period (min) 15

Splits and Phases: 3: NE 152nd Avenue & NE Padden Parkway

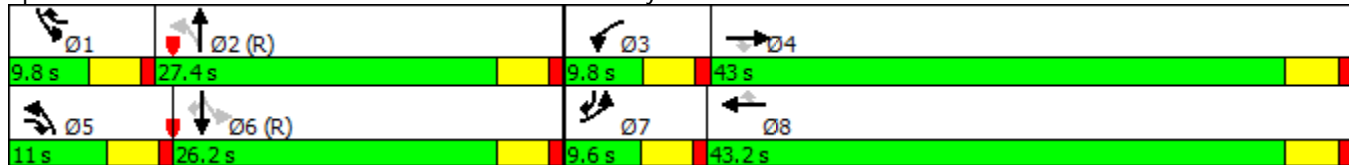

Queues

3: NE 152nd Avenue & NE Padden Parkway

02/13/2019

























Lane Group	EBL	EBT	EBR	WBL	WBT	WBR	NBL	NBT	SBL	SBT	SBR
Lane Group Flow (vph)	29	786	235	88	724	336	42	410	105	152	221
v/c Ratio	0.29	0.98	0.24	0.84	0.90	0.35	0.10	0.85	0.56	0.34	0.32
Control Delay	48.3	53.8	2.0	96.8	39.8	5.3	19.5	50.0	32.9	30.8	5.2
Queue Delay	0.0	0.0	0.0	0.0	0.0	0.0	0.0	0.0	0.0	0.0	0.0
Total Delay	48.3	53.8	2.0	96.8	39.8	5.3	19.5	50.0	32.9	30.8	5.2
Queue Length 50th (ft)	16	427	0	51	371	33	15	222	40	72	5
Queue Length 95th (ft)	44	#678	31	#137	#597	79	37	#379	#79	126	52
Internal Link Dist (ft)		1422			1500			816		3326	
Turn Bay Length (ft)	330			215		125	205		315		100
Base Capacity (vph)	101	804	985	105	808	959	407	483	186	449	686
Starvation Cap Reductn	0	0	0	0	0	0	0	0	0	0	0
Spillback Cap Reductn	0	0	0	0	0	0	0	0	0	0	0
Storage Cap Reductn	0	0	0	0	0	0	0	0	0	0	0
Reduced v/c Ratio	0.29	0.98	0.24	0.84	0.90	0.35	0.10	0.85	0.56	0.34	0.32

Intersection Summary

95th percentile volume exceeds capacity, queue may be longer.
 Queue shown is maximum after two cycles.

HCM 2010 Signalized Intersection Summary
 3: NE 152nd Avenue & NE Padden Parkway

02/13/2019

												
Movement	EBL	EBT	EBR	WBL	WBT	WBR	NBL	NBT	NBR	SBL	SBT	SBR
Lane Configurations												
Traffic Volume (veh/h)	29	786	235	88	724	336	42	410	0	105	152	221
Future Volume (veh/h)	29	786	235	88	724	336	42	410	0	105	152	221
Number	7	4	14	3	8	18	5	2	12	1	6	16
Initial Q (Qb), veh	0	0	0	0	0	0	0	0	0	0	0	0
Ped-Bike Adj(A_pbT)	1.00		1.00	1.00		1.00	1.00		1.00	1.00		1.00
Parking Bus, Adj	1.00	1.00	1.00	1.00	1.00	1.00	1.00	1.00	1.00	1.00	1.00	1.00
Adj Sat Flow, veh/h/ln	1881	1881	1881	1881	1881	1881	1900	1900	1900	1863	1863	1863
Adj Flow Rate, veh/h	29	786	235	88	724	336	42	410	0	105	152	221
Adj No. of Lanes	1	1	1	1	1	1	1	1	0	1	1	1
Peak Hour Factor	1.00	1.00	1.00	1.00	1.00	1.00	1.00	1.00	1.00	1.00	1.00	1.00
Percent Heavy Veh, %	1	1	1	1	1	1	0	0	0	2	2	2
Cap, veh/h	102	805	800	106	809	782	389	483	0	232	449	471
Arrive On Green	0.06	0.43	0.43	0.06	0.43	0.43	0.07	0.25	0.00	0.06	0.24	0.24
Sat Flow, veh/h	1792	1881	1599	1792	1881	1599	1810	1900	0	1774	1863	1583
Grp Volume(v), veh/h	29	786	235	88	724	336	42	410	0	105	152	221
Grp Sat Flow(s),veh/h/ln	1792	1881	1599	1792	1881	1599	1810	1900	0	1774	1863	1583
Q Serve(g_s), s	1.4	37.0	7.8	4.4	32.1	12.2	1.5	18.5	0.0	4.0	6.1	10.3
Cycle Q Clear(g_c), s	1.4	37.0	7.8	4.4	32.1	12.2	1.5	18.5	0.0	4.0	6.1	10.3
Prop In Lane	1.00		1.00	1.00		1.00	1.00		0.00	1.00		1.00
Lane Grp Cap(c), veh/h	102	805	800	106	809	782	389	483	0	232	449	471
V/C Ratio(X)	0.29	0.98	0.29	0.83	0.90	0.43	0.11	0.85	0.00	0.45	0.34	0.47
Avail Cap(c_a), veh/h	102	805	800	106	809	782	389	483	0	232	449	471
HCM Platoon Ratio	1.00	1.00	1.00	1.00	1.00	1.00	1.00	1.00	1.00	1.00	1.00	1.00
Upstream Filter(I)	1.00	1.00	1.00	1.00	1.00	1.00	1.00	1.00	0.00	1.00	1.00	1.00
Uniform Delay (d), s/veh	40.7	25.3	13.2	41.9	23.8	14.9	21.9	31.9	0.0	25.3	28.2	25.8
Incr Delay (d2), s/veh	6.9	26.6	0.9	51.0	14.5	1.7	0.6	16.7	0.0	6.2	2.0	3.3
Initial Q Delay(d3),s/veh	0.0	0.0	0.0	0.0	0.0	0.0	0.0	0.0	0.0	0.0	0.0	0.0
%ile BackOfQ(50%),veh/ln	0.9	24.9	3.6	3.7	19.8	5.7	0.8	11.9	0.0	2.3	3.4	4.9
LnGrp Delay(d),s/veh	47.6	51.9	14.1	92.9	38.3	16.6	22.5	48.6	0.0	31.5	30.3	29.1
LnGrp LOS	D	D	B	F	D	B	C	D		C	C	C
Approach Vol, veh/h		1050			1148			452			478	
Approach Delay, s/veh		43.3			36.1			46.2			30.0	
Approach LOS		D			D			D			C	
Timer	1	2	3	4	5	6	7	8				
Assigned Phs	1	2	3	4	5	6	7	8				
Phs Duration (G+Y+Rc), s	9.8	27.4	9.8	43.0	11.0	26.2	9.6	43.2				
Change Period (Y+Rc), s	4.5	4.5	4.5	4.5	4.5	4.5	4.5	4.5				
Max Green Setting (Gmax), s	5.3	22.9	5.3	38.5	6.5	21.7	5.1	38.7				
Max Q Clear Time (g_c+I1), s	6.0	20.5	6.4	39.0	3.5	12.3	3.4	34.1				
Green Ext Time (p_c), s	0.0	1.0	0.0	0.0	0.0	2.9	0.0	3.7				
Intersection Summary												
HCM 2010 Ctrl Delay			39.0									
HCM 2010 LOS			D									

Lanes, Volumes, Timings
4: NE 152nd Avenue & NE 99th Street

02/12/2019



Lane Group	EBL	EBT	EBR	WBL	WBT	WBR	NBL	NBT	NBR	SBL	SBT	SBR
Lane Configurations		↕	↗		↕			↕			↕	
Traffic Volume (vph)	201	88	67	9	22	29	44	507	21	69	364	39
Future Volume (vph)	201	88	67	9	22	29	44	507	21	69	364	39
Ideal Flow (vphpl)	1900	1900	1900	1900	1900	1900	1900	1900	1900	1900	1900	1900
Storage Length (ft)	0		140	0		0	0		0	0		0
Storage Lanes	0		1	0		0	0		0	0		0
Taper Length (ft)	25			25			25			25		
Lane Util. Factor	1.00	1.00	1.00	1.00	1.00	1.00	1.00	1.00	1.00	1.00	1.00	1.00
Frt			0.850		0.935			0.995			0.989	
Flt Protected		0.966			0.993			0.996			0.993	
Satd. Flow (prot)	0	1782	1568	0	1764	0	0	1846	0	0	1866	0
Flt Permitted		0.966			0.993			0.996			0.993	
Satd. Flow (perm)	0	1782	1568	0	1764	0	0	1846	0	0	1866	0
Link Speed (mph)		35			35			35			35	
Link Distance (ft)		8013			3202			3406			4539	
Travel Time (s)		156.1			62.4			66.4			88.4	
Peak Hour Factor	1.00	1.00	1.00	1.00	1.00	1.00	1.00	1.00	1.00	1.00	1.00	1.00
Heavy Vehicles (%)	3%	3%	3%	0%	0%	0%	2%	2%	2%	0%	0%	0%
Adj. Flow (vph)	201	88	67	9	22	29	44	507	21	69	364	39
Shared Lane Traffic (%)												
Lane Group Flow (vph)	0	289	67	0	60	0	0	572	0	0	472	0
Enter Blocked Intersection	No	No	No	No	No	No	No	No	No	No	No	No
Lane Alignment	Left	Left	Right	Left	Left	Right	Left	Left	Right	Left	Left	Right
Median Width(ft)		12			12			12			12	
Link Offset(ft)		0			0			0			0	
Crosswalk Width(ft)		16			16			16			16	
Two way Left Turn Lane												
Headway Factor	1.00	1.00	1.00	1.00	1.00	1.00	1.00	1.00	1.00	1.00	1.00	1.00
Turning Speed (mph)	15		9	15		9	15		9	15		9
Sign Control		Stop			Stop			Stop			Stop	

Intersection Summary

Area Type:	Other
Control Type:	Unsignalized
Intersection Capacity Utilization	70.4%
Analysis Period (min)	15
	ICU Level of Service C

Intersection	
Intersection Delay, s/veh	48.6
Intersection LOS	E

Movement	EBL	EBT	EBR	WBL	WBT	WBR	NBL	NBT	NBR	SBL	SBT	SBR
Lane Configurations		↔	↔		↔			↔			↔	
Traffic Vol, veh/h	201	88	67	9	22	29	44	507	21	69	364	39
Future Vol, veh/h	201	88	67	9	22	29	44	507	21	69	364	39
Peak Hour Factor	1.00	1.00	1.00	1.00	1.00	1.00	1.00	1.00	1.00	1.00	1.00	1.00
Heavy Vehicles, %	3	3	3	0	0	0	2	2	2	0	0	0
Mvmt Flow	201	88	67	9	22	29	44	507	21	69	364	39
Number of Lanes	0	1	1	0	1	0	0	1	0	0	1	0

Approach	EB	WB	NB	SB
Opposing Approach	WB	EB	SB	NB
Opposing Lanes	1	2	1	1
Conflicting Approach Left	SB	NB	EB	WB
Conflicting Lanes Left	1	1	2	1
Conflicting Approach Right	NB	SB	WB	EB
Conflicting Lanes Right	1	1	1	2
HCM Control Delay	22.5	13	77.2	38.2
HCM LOS	C	B	F	E

Lane	NBLn1	EBLn1	EBLn2	WBLn1	SBLn1
Vol Left, %	8%	70%	0%	15%	15%
Vol Thru, %	89%	30%	0%	37%	77%
Vol Right, %	4%	0%	100%	48%	8%
Sign Control	Stop	Stop	Stop	Stop	Stop
Traffic Vol by Lane	572	289	67	60	472
LT Vol	44	201	0	9	69
Through Vol	507	88	0	22	364
RT Vol	21	0	67	29	39
Lane Flow Rate	572	289	67	60	472
Geometry Grp	2	7	7	5	2
Degree of Util (X)	1.048	0.649	0.13	0.139	0.858
Departure Headway (Hd)	6.594	8.335	7.253	8.63	6.798
Convergence, Y/N	Yes	Yes	Yes	Yes	Yes
Cap	555	436	497	418	538
Service Time	4.599	6.035	4.953	6.63	4.798
HCM Lane V/C Ratio	1.031	0.663	0.135	0.144	0.877
HCM Control Delay	77.2	25.2	11	13	38.2
HCM Lane LOS	F	D	B	B	E
HCM 95th-tile Q	16.4	4.5	0.4	0.5	9.2

APPENDIX F

2039 “PROPOSED ZONING BUILD OUT” LEVELS OF SERVICE

Lanes, Volumes, Timings
 1: NE 152nd Avenue & NE 119th Street

02/13/2019



Lane Group	EBL	EBT	EBR	WBL	WBT	WBR	NBL	NBT	NBR	SBL	SBT	SBR
Lane Configurations		↕			↕			↕			↕	
Traffic Volume (vph)	52	236	154	27	216	20	151	400	27	20	316	66
Future Volume (vph)	52	236	154	27	216	20	151	400	27	20	316	66
Ideal Flow (vphpl)	1900	1900	1900	1900	1900	1900	1900	1900	1900	1900	1900	1900
Lane Util. Factor	1.00	1.00	1.00	1.00	1.00	1.00	1.00	1.00	1.00	1.00	1.00	1.00
Frt		0.953			0.990			0.994			0.978	
Flt Protected		0.994			0.995			0.987			0.998	
Satd. Flow (prot)	0	1765	0	0	1782	0	0	1792	0	0	1854	0
Flt Permitted		0.938			0.944			0.810			0.965	
Satd. Flow (perm)	0	1665	0	0	1691	0	0	1471	0	0	1793	0
Right Turn on Red			Yes			Yes			Yes			Yes
Satd. Flow (RTOR)		48			7			6			25	
Link Speed (mph)		50			50			35			40	
Link Distance (ft)		2778			2259			4539			916	
Travel Time (s)		37.9			30.8			88.4			15.6	
Peak Hour Factor	1.00	1.00	1.00	1.00	1.00	1.00	1.00	1.00	1.00	1.00	1.00	1.00
Heavy Vehicles (%)	2%	2%	2%	5%	5%	5%	4%	4%	4%	0%	0%	0%
Adj. Flow (vph)	52	236	154	27	216	20	151	400	27	20	316	66
Shared Lane Traffic (%)												
Lane Group Flow (vph)	0	442	0	0	263	0	0	578	0	0	402	0
Enter Blocked Intersection	No	No	No	No	No	No	No	No	No	No	No	No
Lane Alignment	Left	Left	Right	Left	Left	Right	Left	Left	Right	Left	Left	Right
Median Width(ft)		0			0			0			0	
Link Offset(ft)		0			0			0			0	
Crosswalk Width(ft)		16			16			16			16	
Two way Left Turn Lane												
Headway Factor	1.00	1.00	1.00	1.00	1.00	1.00	1.00	1.00	1.00	1.00	1.00	1.00
Turning Speed (mph)	15		9	15		9	15		9	15		9
Number of Detectors	1	2		1	2		1	2		1	2	
Detector Template	Left	Thru		Left	Thru		Left	Thru		Left	Thru	
Leading Detector (ft)	20	100		20	100		20	100		20	100	
Trailing Detector (ft)	0	0		0	0		0	0		0	0	
Detector 1 Position(ft)	0	0		0	0		0	0		0	0	
Detector 1 Size(ft)	20	6		20	6		20	6		20	6	
Detector 1 Type	Cl+Ex	Cl+Ex		Cl+Ex	Cl+Ex		Cl+Ex	Cl+Ex		Cl+Ex	Cl+Ex	
Detector 1 Channel												
Detector 1 Extend (s)	0.0	0.0		0.0	0.0		0.0	0.0		0.0	0.0	
Detector 1 Queue (s)	0.0	0.0		0.0	0.0		0.0	0.0		0.0	0.0	
Detector 1 Delay (s)	0.0	0.0		0.0	0.0		0.0	0.0		0.0	0.0	
Detector 2 Position(ft)		94			94			94			94	
Detector 2 Size(ft)		6			6			6			6	
Detector 2 Type		Cl+Ex			Cl+Ex			Cl+Ex			Cl+Ex	
Detector 2 Channel												
Detector 2 Extend (s)		0.0			0.0			0.0			0.0	
Turn Type	Perm	NA		Perm	NA		Perm	NA		Perm	NA	
Protected Phases		4			8			2			6	
Permitted Phases	4			8			2			6		
Detector Phase	4	4		8	8		2	2		6	6	
Switch Phase												

Lanes, Volumes, Timings
 1: NE 152nd Avenue & NE 119th Street

02/13/2019



Lane Group	EBL	EBT	EBR	WBL	WBT	WBR	NBL	NBT	NBR	SBL	SBT	SBR
Minimum Initial (s)	5.0	5.0		5.0	5.0		5.0	5.0		5.0	5.0	
Minimum Split (s)	22.5	22.5		22.5	22.5		22.5	22.5		22.5	22.5	
Total Split (s)	24.0	24.0		24.0	24.0		36.0	36.0		36.0	36.0	
Total Split (%)	40.0%	40.0%		40.0%	40.0%		60.0%	60.0%		60.0%	60.0%	
Maximum Green (s)	19.5	19.5		19.5	19.5		31.5	31.5		31.5	31.5	
Yellow Time (s)	3.5	3.5		3.5	3.5		3.5	3.5		3.5	3.5	
All-Red Time (s)	1.0	1.0		1.0	1.0		1.0	1.0		1.0	1.0	
Lost Time Adjust (s)		0.0			0.0			0.0			0.0	
Total Lost Time (s)		4.5			4.5			4.5			4.5	
Lead/Lag												
Lead-Lag Optimize?												
Vehicle Extension (s)	3.0	3.0		3.0	3.0		3.0	3.0		3.0	3.0	
Recall Mode	None	None		None	None		Min	Min		Min	Min	
Walk Time (s)	7.0	7.0		7.0	7.0		7.0	7.0		7.0	7.0	
Flash Dont Walk (s)	11.0	11.0		11.0	11.0		11.0	11.0		11.0	11.0	
Pedestrian Calls (#/hr)	0	0		0	0		0	0		0	0	
Act Effect Green (s)		16.2			16.2			24.1			24.1	
Actuated g/C Ratio		0.32			0.32			0.48			0.48	
v/c Ratio		0.77			0.47			0.81			0.46	
Control Delay		26.1			17.9			21.9			10.0	
Queue Delay		0.0			0.0			0.0			0.0	
Total Delay		26.1			17.9			21.9			10.0	
LOS		C			B			C			B	
Approach Delay		26.1			17.9			21.9			10.0	
Approach LOS		C			B			C			B	

Intersection Summary

Area Type:	Other
Cycle Length:	60
Actuated Cycle Length:	49.9
Natural Cycle:	55
Control Type:	Actuated-Uncoordinated
Maximum v/c Ratio:	0.81
Intersection Signal Delay:	19.5
Intersection LOS:	B
Intersection Capacity Utilization:	98.1%
ICU Level of Service:	F
Analysis Period (min):	15

Splits and Phases: 1: NE 152nd Avenue & NE 119th Street

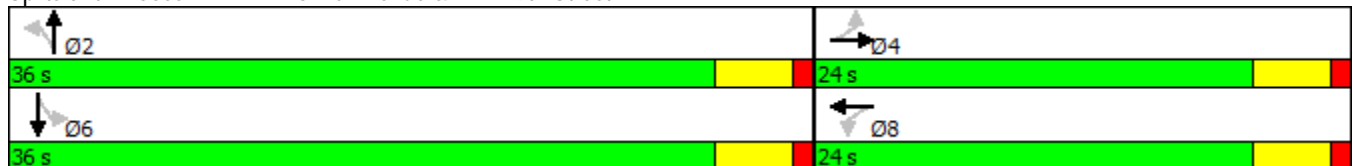

Queues

1: NE 152nd Avenue & NE 119th Street

02/13/2019

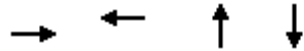

















Lane Group	EBT	WBT	NBT	SBT
Lane Group Flow (vph)	442	263	578	402
v/c Ratio	0.77	0.47	0.81	0.46
Control Delay	26.1	17.9	21.9	10.0
Queue Delay	0.0	0.0	0.0	0.0
Total Delay	26.1	17.9	21.9	10.0
Queue Length 50th (ft)	110	63	143	72
Queue Length 95th (ft)	#263	132	#288	131
Internal Link Dist (ft)	2698	2179	4459	836
Turn Bay Length (ft)				
Base Capacity (vph)	719	706	989	1211
Starvation Cap Reductn	0	0	0	0
Spillback Cap Reductn	0	0	0	0
Storage Cap Reductn	0	0	0	0
Reduced v/c Ratio	0.61	0.37	0.58	0.33

Intersection Summary

95th percentile volume exceeds capacity, queue may be longer.
 Queue shown is maximum after two cycles.

HCM 2010 Signalized Intersection Summary
 1: NE 152nd Avenue & NE 119th Street

02/13/2019

												
Movement	EBL	EBT	EBR	WBL	WBT	WBR	NBL	NBT	NBR	SBL	SBT	SBR
Lane Configurations												
Traffic Volume (veh/h)	52	236	154	27	216	20	151	400	27	20	316	66
Future Volume (veh/h)	52	236	154	27	216	20	151	400	27	20	316	66
Number	7	4	14	3	8	18	5	2	12	1	6	16
Initial Q (Qb), veh	0	0	0	0	0	0	0	0	0	0	0	0
Ped-Bike Adj(A_pbT)	1.00		1.00	1.00		1.00	1.00		1.00	1.00		1.00
Parking Bus, Adj	1.00	1.00	1.00	1.00	1.00	1.00	1.00	1.00	1.00	1.00	1.00	1.00
Adj Sat Flow, veh/h/ln	1900	1863	1900	1900	1810	1900	1900	1827	1900	1900	1900	1900
Adj Flow Rate, veh/h	52	236	154	27	216	20	151	400	27	20	316	66
Adj No. of Lanes	0	1	0	0	1	0	0	1	0	0	1	0
Peak Hour Factor	1.00	1.00	1.00	1.00	1.00	1.00	1.00	1.00	1.00	1.00	1.00	1.00
Percent Heavy Veh, %	2	2	2	5	5	5	4	4	4	0	0	0
Cap, veh/h	129	324	194	117	505	44	254	553	35	101	694	140
Arrive On Green	0.33	0.33	0.33	0.33	0.33	0.33	0.47	0.47	0.47	0.47	0.47	0.47
Sat Flow, veh/h	119	979	587	85	1528	133	327	1182	74	35	1483	298
Grp Volume(v), veh/h	442	0	0	263	0	0	578	0	0	402	0	0
Grp Sat Flow(s),veh/h/ln	1684	0	0	1746	0	0	1583	0	0	1816	0	0
Q Serve(g_s), s	4.8	0.0	0.0	0.0	0.0	0.0	6.2	0.0	0.0	0.0	0.0	0.0
Cycle Q Clear(g_c), s	10.5	0.0	0.0	5.2	0.0	0.0	12.8	0.0	0.0	6.6	0.0	0.0
Prop In Lane	0.12		0.35	0.10		0.08	0.26		0.05	0.05		0.16
Lane Grp Cap(c), veh/h	647	0	0	666	0	0	843	0	0	934	0	0
V/C Ratio(X)	0.68	0.00	0.00	0.39	0.00	0.00	0.69	0.00	0.00	0.43	0.00	0.00
Avail Cap(c_a), veh/h	819	0	0	838	0	0	1191	0	0	1351	0	0
HCM Platoon Ratio	1.00	1.00	1.00	1.00	1.00	1.00	1.00	1.00	1.00	1.00	1.00	1.00
Upstream Filter(I)	1.00	0.00	0.00	1.00	0.00	0.00	1.00	0.00	0.00	1.00	0.00	0.00
Uniform Delay (d), s/veh	13.5	0.0	0.0	11.8	0.0	0.0	9.5	0.0	0.0	8.1	0.0	0.0
Incr Delay (d2), s/veh	1.7	0.0	0.0	0.4	0.0	0.0	1.0	0.0	0.0	0.3	0.0	0.0
Initial Q Delay(d3),s/veh	0.0	0.0	0.0	0.0	0.0	0.0	0.0	0.0	0.0	0.0	0.0	0.0
%ile BackOfQ(50%),veh/ln	5.2	0.0	0.0	2.6	0.0	0.0	6.0	0.0	0.0	3.4	0.0	0.0
LnGrp Delay(d),s/veh	15.1	0.0	0.0	12.1	0.0	0.0	10.5	0.0	0.0	8.4	0.0	0.0
LnGrp LOS	B			B			B			A		
Approach Vol, veh/h		442			263			578			402	
Approach Delay, s/veh		15.1			12.1			10.5			8.4	
Approach LOS		B			B			B			A	
Timer	1	2	3	4	5	6	7	8				
Assigned Phs		2		4		6		8				
Phs Duration (G+Y+Rc), s		25.5		19.3		25.5		19.3				
Change Period (Y+Rc), s		4.5		4.5		4.5		4.5				
Max Green Setting (Gmax), s		31.5		19.5		31.5		19.5				
Max Q Clear Time (g_c+I1), s		14.8		12.5		8.6		7.2				
Green Ext Time (p_c), s		6.1		2.3		7.0		3.2				
Intersection Summary												
HCM 2010 Ctrl Delay				11.5								
HCM 2010 LOS				B								

Lanes, Volumes, Timings
 2: NE 117th Avenue (SR 503) & NE 99th Street

02/13/2019



Lane Group	EBL	EBT	EBR	WBL	WBT	WBR	NBL	NBT	NBR	SBL	SBT	SBR
Lane Configurations												
Traffic Volume (vph)	250	141	51	209	44	209	31	1653	225	290	1304	57
Future Volume (vph)	250	141	51	209	44	209	31	1653	225	290	1304	57
Ideal Flow (vphpl)	1900	1900	1900	1900	1900	1900	1900	1900	1900	1900	1900	1900
Storage Length (ft)	300		215	300		230	580		315	460		250
Storage Lanes	1		1	1		1	1		1	1		1
Taper Length (ft)	25			25			25			25		
Lane Util. Factor	1.00	1.00	1.00	1.00	1.00	1.00	1.00	0.95	1.00	1.00	0.95	1.00
Frt			0.850			0.850			0.850			0.850
Flt Protected	0.950			0.950			0.950			0.950		
Satd. Flow (prot)	1736	1827	1553	1787	1881	1599	1770	3539	1583	1736	3471	1553
Flt Permitted	0.581			0.605			0.175			0.063		
Satd. Flow (perm)	1061	1827	1553	1138	1881	1599	326	3539	1583	115	3471	1553
Right Turn on Red			Yes			Yes			Yes			Yes
Satd. Flow (RTOR)			95			55			225			57
Link Speed (mph)		30			35			40				40
Link Distance (ft)		952			8013			3477				3940
Travel Time (s)		21.6			156.1			59.3				67.2
Peak Hour Factor	1.00	1.00	1.00	1.00	1.00	1.00	1.00	1.00	1.00	1.00	1.00	1.00
Heavy Vehicles (%)	4%	4%	4%	1%	1%	1%	2%	2%	2%	4%	4%	4%
Adj. Flow (vph)	250	141	51	209	44	209	31	1653	225	290	1304	57
Shared Lane Traffic (%)												
Lane Group Flow (vph)	250	141	51	209	44	209	31	1653	225	290	1304	57
Enter Blocked Intersection	No	No	No	No	No	No	No	No	No	No	No	No
Lane Alignment	Left	Left	Right	Left	Left	Right	Left	Left	Right	Left	Left	Right
Median Width(ft)		12			12			12				12
Link Offset(ft)		0			0			0				0
Crosswalk Width(ft)		16			16			16				16
Two way Left Turn Lane												
Headway Factor	1.00	1.00	1.00	1.00	1.00	1.00	1.00	1.00	1.00	1.00	1.00	1.00
Turning Speed (mph)	15		9	15		9	15		9	15		9
Number of Detectors	1	2	1	1	2	1	1	2	1	1	2	1
Detector Template	Left	Thru	Right	Left	Thru	Right	Left	Thru	Right	Left	Thru	Right
Leading Detector (ft)	20	100	20	20	100	20	20	100	20	20	100	20
Trailing Detector (ft)	0	0	0	0	0	0	0	0	0	0	0	0
Detector 1 Position(ft)	0	0	0	0	0	0	0	0	0	0	0	0
Detector 1 Size(ft)	20	6	20	20	6	20	20	6	20	20	6	20
Detector 1 Type	Cl+Ex	Cl+Ex	Cl+Ex	Cl+Ex	Cl+Ex	Cl+Ex	Cl+Ex	Cl+Ex	Cl+Ex	Cl+Ex	Cl+Ex	Cl+Ex
Detector 1 Channel												
Detector 1 Extend (s)	0.0	0.0	0.0	0.0	0.0	0.0	0.0	0.0	0.0	0.0	0.0	0.0
Detector 1 Queue (s)	0.0	0.0	0.0	0.0	0.0	0.0	0.0	0.0	0.0	0.0	0.0	0.0
Detector 1 Delay (s)	0.0	0.0	0.0	0.0	0.0	0.0	0.0	0.0	0.0	0.0	0.0	0.0
Detector 2 Position(ft)		94			94			94				94
Detector 2 Size(ft)		6			6			6				6
Detector 2 Type		Cl+Ex			Cl+Ex			Cl+Ex				Cl+Ex
Detector 2 Channel												
Detector 2 Extend (s)		0.0			0.0			0.0				0.0
Turn Type	pm+pt	NA	pm+ov	pm+pt	NA	pm+ov	pm+pt	NA	pm+ov	pm+pt	NA	pm+ov
Protected Phases	7	4	5	3	8	1	5	2	3	1	6	7

Lanes, Volumes, Timings
 2: NE 117th Avenue (SR 503) & NE 99th Street

02/13/2019



Lane Group	EBL	EBT	EBR	WBL	WBT	WBR	NBL	NBT	NBR	SBL	SBT	SBR
Permitted Phases	4		4	8		8	2		2	6		6
Detector Phase	7	4	5	3	8	1	5	2	3	1	6	7
Switch Phase												
Minimum Initial (s)	5.0	5.0	5.0	5.0	5.0	5.0	5.0	5.0	5.0	5.0	5.0	5.0
Minimum Split (s)	9.5	22.5	9.5	9.5	22.5	9.5	9.5	22.5	9.5	9.5	22.5	9.5
Total Split (s)	12.2	22.5	9.6	12.2	22.5	21.2	9.6	64.1	12.2	21.2	75.7	12.2
Total Split (%)	10.2%	18.8%	8.0%	10.2%	18.8%	17.7%	8.0%	53.4%	10.2%	17.7%	63.1%	10.2%
Maximum Green (s)	7.7	18.0	5.1	7.7	18.0	16.7	5.1	59.6	7.7	16.7	71.2	7.7
Yellow Time (s)	3.5	3.5	3.5	3.5	3.5	3.5	3.5	3.5	3.5	3.5	3.5	3.5
All-Red Time (s)	1.0	1.0	1.0	1.0	1.0	1.0	1.0	1.0	1.0	1.0	1.0	1.0
Lost Time Adjust (s)	0.0	0.0	0.0	0.0	0.0	0.0	0.0	0.0	0.0	0.0	0.0	0.0
Total Lost Time (s)	4.5	4.5	4.5	4.5	4.5	4.5	4.5	4.5	4.5	4.5	4.5	4.5
Lead/Lag	Lead	Lag	Lead	Lead	Lag	Lead	Lead	Lag	Lead	Lead	Lag	Lead
Lead-Lag Optimize?	Yes	Yes	Yes	Yes	Yes	Yes	Yes	Yes	Yes	Yes	Yes	Yes
Vehicle Extension (s)	3.0	3.0	3.0	3.0	3.0	3.0	3.0	3.0	3.0	3.0	3.0	3.0
Recall Mode	None	None	None	None	None	None	None	Min	None	None	Min	None
Walk Time (s)		7.0			7.0			7.0			7.0	
Flash Dont Walk (s)		11.0			11.0			11.0			11.0	
Pedestrian Calls (#/hr)		0			0			0			0	
Act Effct Green (s)	22.5	13.7	23.4	19.5	13.0	32.0	62.7	57.6	69.9	78.9	71.4	87.7
Actuated g/C Ratio	0.20	0.12	0.21	0.17	0.11	0.28	0.55	0.51	0.61	0.69	0.63	0.77
v/c Ratio	0.92	0.64	0.13	0.88	0.21	0.43	0.13	0.92	0.21	0.91	0.60	0.05
Control Delay	81.3	61.9	1.5	76.5	47.8	26.2	8.5	36.4	1.8	66.0	15.0	1.6
Queue Delay	0.0	0.0	0.0	0.0	0.0	0.0	0.0	0.0	0.0	0.0	0.0	0.0
Total Delay	81.3	61.9	1.5	76.5	47.8	26.2	8.5	36.4	1.8	66.0	15.0	1.6
LOS	F	E	A	E	D	C	A	D	A	E	B	A
Approach Delay		65.9			51.0			31.9			23.5	
Approach LOS		E			D			C			C	

Intersection Summary

Area Type: Other
 Cycle Length: 120
 Actuated Cycle Length: 113.9
 Natural Cycle: 100
 Control Type: Actuated-Uncoordinated
 Maximum v/c Ratio: 0.92
 Intersection Signal Delay: 34.1
 Intersection LOS: C
 Intersection Capacity Utilization 95.8%
 ICU Level of Service F
 Analysis Period (min) 15

Splits and Phases: 2: NE 117th Avenue (SR 503) & NE 99th Street

Ø1	Ø2	Ø3	Ø4
21.2 s	64.1 s	12.2 s	22.5 s
Ø5	Ø6	Ø7	Ø8
9.6 s	75.7 s	12.2 s	22.5 s

Queues

2: NE 117th Avenue (SR 503) & NE 99th Street

02/13/2019

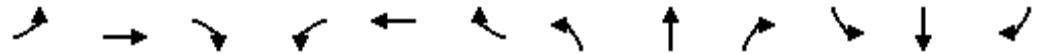

























Lane Group	EBL	EBT	EBR	WBL	WBT	WBR	NBL	NBT	NBR	SBL	SBT	SBR
Lane Group Flow (vph)	250	141	51	209	44	209	31	1653	225	290	1304	57
v/c Ratio	0.92	0.64	0.13	0.88	0.21	0.43	0.13	0.92	0.21	0.91	0.60	0.05
Control Delay	81.3	61.9	1.5	76.5	47.8	26.2	8.5	36.4	1.8	66.0	15.0	1.6
Queue Delay	0.0	0.0	0.0	0.0	0.0	0.0	0.0	0.0	0.0	0.0	0.0	0.0
Total Delay	81.3	61.9	1.5	76.5	47.8	26.2	8.5	36.4	1.8	66.0	15.0	1.6
Queue Length 50th (ft)	~175	102	0	138	30	89	6	574	0	165	297	0
Queue Length 95th (ft)	#338	169	5	#233	66	158	18	#795	31	#350	397	12
Internal Link Dist (ft)		872			7933			3397			3860	
Turn Bay Length (ft)	300		215	300		230	580		315	460		250
Base Capacity (vph)	272	289	394	238	298	489	244	1858	1057	317	2177	1208
Starvation Cap Reductn	0	0	0	0	0	0	0	0	0	0	0	0
Spillback Cap Reductn	0	0	0	0	0	0	0	0	0	0	0	0
Storage Cap Reductn	0	0	0	0	0	0	0	0	0	0	0	0
Reduced v/c Ratio	0.92	0.49	0.13	0.88	0.15	0.43	0.13	0.89	0.21	0.91	0.60	0.05

Intersection Summary

- ~ Volume exceeds capacity, queue is theoretically infinite.
Queue shown is maximum after two cycles.
- # 95th percentile volume exceeds capacity, queue may be longer.
Queue shown is maximum after two cycles.

HCM 2010 Signalized Intersection Summary
 2: NE 117th Avenue (SR 503) & NE 99th Street

02/13/2019

												
Movement	EBL	EBT	EBR	WBL	WBT	WBR	NBL	NBT	NBR	SBL	SBT	SBR
Lane Configurations												
Traffic Volume (veh/h)	250	141	51	209	44	209	31	1653	225	290	1304	57
Future Volume (veh/h)	250	141	51	209	44	209	31	1653	225	290	1304	57
Number	7	4	14	3	8	18	5	2	12	1	6	16
Initial Q (Qb), veh	0	0	0	0	0	0	0	0	0	0	0	0
Ped-Bike Adj(A_pbT)	1.00		1.00	1.00		1.00	1.00		1.00	1.00		1.00
Parking Bus, Adj	1.00	1.00	1.00	1.00	1.00	1.00	1.00	1.00	1.00	1.00	1.00	1.00
Adj Sat Flow, veh/h/ln	1827	1827	1827	1881	1881	1881	1863	1863	1863	1827	1827	1827
Adj Flow Rate, veh/h	250	141	51	209	44	209	31	1653	225	290	1304	57
Adj No. of Lanes	1	1	1	1	1	1	1	2	1	1	2	1
Peak Hour Factor	1.00	1.00	1.00	1.00	1.00	1.00	1.00	1.00	1.00	1.00	1.00	1.00
Percent Heavy Veh, %	4	4	4	1	1	1	2	2	2	4	4	4
Cap, veh/h	301	243	249	254	250	429	265	1805	913	316	2145	1063
Arrive On Green	0.07	0.13	0.13	0.07	0.13	0.13	0.03	0.51	0.51	0.14	0.62	0.62
Sat Flow, veh/h	1740	1827	1553	1792	1881	1599	1774	3539	1583	1740	3471	1553
Grp Volume(v), veh/h	250	141	51	209	44	209	31	1653	225	290	1304	57
Grp Sat Flow(s),veh/h/ln	1740	1827	1553	1792	1881	1599	1774	1770	1583	1740	1736	1553
Q Serve(g_s), s	7.7	8.4	3.3	7.7	2.4	12.7	1.0	49.7	8.1	13.5	26.6	1.4
Cycle Q Clear(g_c), s	7.7	8.4	3.3	7.7	2.4	12.7	1.0	49.7	8.1	13.5	26.6	1.4
Prop In Lane	1.00		1.00	1.00		1.00	1.00		1.00	1.00		1.00
Lane Grp Cap(c), veh/h	301	243	249	254	250	429	265	1805	913	316	2145	1063
V/C Ratio(X)	0.83	0.58	0.21	0.82	0.18	0.49	0.12	0.92	0.25	0.92	0.61	0.05
Avail Cap(c_a), veh/h	301	284	284	254	293	465	295	1822	921	332	2145	1063
HCM Platoon Ratio	1.00	1.00	1.00	1.00	1.00	1.00	1.00	1.00	1.00	1.00	1.00	1.00
Upstream Filter(I)	1.00	1.00	1.00	1.00	1.00	1.00	1.00	1.00	1.00	1.00	1.00	1.00
Uniform Delay (d), s/veh	45.8	47.2	42.2	45.7	44.6	35.7	13.5	26.1	12.1	36.0	13.5	6.0
Incr Delay (d2), s/veh	17.4	2.2	0.4	19.3	0.3	0.9	0.2	7.7	0.1	28.4	0.5	0.0
Initial Q Delay(d3),s/veh	0.0	0.0	0.0	0.0	0.0	0.0	0.0	0.0	0.0	0.0	0.0	0.0
%ile BackOfQ(50%),veh/ln	5.7	4.4	1.4	4.2	1.3	5.7	0.5	26.0	3.5	11.6	12.8	0.6
LnGrp Delay(d),s/veh	63.2	49.4	42.6	65.0	44.9	36.5	13.7	33.8	12.2	64.4	14.0	6.0
LnGrp LOS	E	D	D	E	D	D	B	C	B	E	B	A
Approach Vol, veh/h		442			462			1909			1651	
Approach Delay, s/veh		56.4			50.2			30.9			22.6	
Approach LOS		E			D			C			C	
Timer	1	2	3	4	5	6	7	8				
Assigned Phs	1	2	3	4	5	6	7	8				
Phs Duration (G+Y+Rc), s	20.1	63.5	12.2	19.9	7.7	76.0	12.2	19.9				
Change Period (Y+Rc), s	4.5	4.5	4.5	4.5	4.5	4.5	4.5	4.5				
Max Green Setting (Gmax), s	16.7	59.6	7.7	18.0	5.1	71.2	7.7	18.0				
Max Q Clear Time (g_c+I1), s	15.5	51.7	9.7	10.4	3.0	28.6	9.7	14.7				
Green Ext Time (p_c), s	0.1	7.3	0.0	1.2	0.0	35.4	0.0	0.6				
Intersection Summary												
HCM 2010 Ctrl Delay			32.4									
HCM 2010 LOS			C									

Lanes, Volumes, Timings
 3: NE 152nd Avenue & NE Padden Parkway

02/13/2019



Lane Group	EBL	EBT	EBR	WBL	WBT	WBR	NBL	NBT	NBR	SBL	SBT	SBR
Lane Configurations												
Traffic Volume (vph)	37	786	235	88	724	345	42	446	0	79	55	200
Future Volume (vph)	37	786	235	88	724	345	42	446	0	79	55	200
Ideal Flow (vphpl)	1900	1900	1900	1900	1900	1900	1900	1900	1900	1900	1900	1900
Storage Length (ft)	330		0	215		125	205		0	315		100
Storage Lanes	1		1	1		1	1		0	1		1
Taper Length (ft)	25			25			25			25		
Lane Util. Factor	1.00	1.00	1.00	1.00	1.00	1.00	1.00	1.00	1.00	1.00	1.00	1.00
Frt			0.850			0.850						0.850
Flt Protected	0.950			0.950			0.950			0.950		
Satd. Flow (prot)	1787	1881	1599	1787	1881	1599	1805	1900	0	1770	1863	1583
Flt Permitted	0.950			0.950			0.683			0.184		
Satd. Flow (perm)	1787	1881	1599	1787	1881	1599	1298	1900	0	343	1863	1583
Right Turn on Red			Yes			Yes			Yes			Yes
Satd. Flow (RTOR)			235			176						200
Link Speed (mph)		50			50			35				35
Link Distance (ft)		1502			1580			896				3406
Travel Time (s)		20.5			21.5			17.5				66.4
Peak Hour Factor	1.00	1.00	1.00	1.00	1.00	1.00	1.00	1.00	1.00	1.00	1.00	1.00
Heavy Vehicles (%)	1%	1%	1%	1%	1%	1%	0%	0%	0%	2%	2%	2%
Adj. Flow (vph)	37	786	235	88	724	345	42	446	0	79	55	200
Shared Lane Traffic (%)												
Lane Group Flow (vph)	37	786	235	88	724	345	42	446	0	79	55	200
Enter Blocked Intersection	No	No	No	No	No	No	No	No	No	No	No	No
Lane Alignment	Left	Left	Right	Left	Left	Right	Left	Left	Right	Left	Left	Right
Median Width(ft)		12			12			12				12
Link Offset(ft)		0			0			0				0
Crosswalk Width(ft)		16			16			16				16
Two way Left Turn Lane												
Headway Factor	1.00	1.00	1.00	1.00	1.00	1.00	1.00	1.00	1.00	1.00	1.00	1.00
Turning Speed (mph)	15		9	15		9	15		9	15		9
Turn Type	Prot	NA	pm+ov	Prot	NA	pm+ov	pm+pt	NA		pm+pt	NA	pm+ov
Protected Phases	7	4	5	3	8	1	5	2		1	6	7
Permitted Phases			4			8	2			6		6
Minimum Split (s)	9.5	22.5	9.5	9.5	22.5	9.5	9.5	22.5		9.5	22.5	9.5
Total Split (s)	9.6	43.0	11.0	9.8	43.2	9.8	11.0	27.4		9.8	26.2	9.6
Total Split (%)	10.7%	47.8%	12.2%	10.9%	48.0%	10.9%	12.2%	30.4%		10.9%	29.1%	10.7%
Maximum Green (s)	5.1	38.5	6.5	5.3	38.7	5.3	6.5	22.9		5.3	21.7	5.1
Yellow Time (s)	3.5	3.5	3.5	3.5	3.5	3.5	3.5	3.5		3.5	3.5	3.5
All-Red Time (s)	1.0	1.0	1.0	1.0	1.0	1.0	1.0	1.0		1.0	1.0	1.0
Lost Time Adjust (s)	0.0	0.0	0.0	0.0	0.0	0.0	0.0	0.0		0.0	0.0	0.0
Total Lost Time (s)	4.5	4.5	4.5	4.5	4.5	4.5	4.5	4.5		4.5	4.5	4.5
Lead/Lag	Lead	Lag	Lead	Lead	Lag	Lead	Lead	Lag		Lead	Lag	Lead
Lead-Lag Optimize?	Yes	Yes	Yes	Yes	Yes	Yes	Yes	Yes		Yes	Yes	Yes
Walk Time (s)		7.0			7.0			7.0				7.0
Flash Dont Walk (s)		11.0			11.0			11.0				11.0
Pedestrian Calls (#/hr)		0			0			0				0
Act Effct Green (s)	5.1	38.5	49.5	5.3	38.7	48.5	29.4	22.9		27.0	21.7	31.3
Actuated g/C Ratio	0.06	0.43	0.55	0.06	0.43	0.54	0.33	0.25		0.30	0.24	0.35

Lanes, Volumes, Timings
 3: NE 152nd Avenue & NE Padden Parkway

02/13/2019



Lane Group	EBL	EBT	EBR	WBL	WBT	WBR	NBL	NBT	NBR	SBL	SBT	SBR
v/c Ratio	0.37	0.98	0.24	0.84	0.90	0.37	0.09	0.92		0.42	0.12	0.29
Control Delay	51.4	53.8	2.0	96.8	39.8	6.7	19.4	60.1		26.7	27.7	4.4
Queue Delay	0.0	0.0	0.0	0.0	0.0	0.0	0.0	0.0		0.0	0.0	0.0
Total Delay	51.4	53.8	2.0	96.8	39.8	6.7	19.4	60.1		26.7	27.7	4.4
LOS	D	D	A	F	D	A	B	E		C	C	A
Approach Delay		42.2			34.3			56.6			13.5	
Approach LOS		D			C			E			B	

Intersection Summary

Area Type: Other
 Cycle Length: 90
 Actuated Cycle Length: 90
 Offset: 0 (0%), Referenced to phase 2:NBTL and 6:SBTL, Start of Green
 Natural Cycle: 90
 Control Type: Pretimed
 Maximum v/c Ratio: 0.98
 Intersection Signal Delay: 38.3
 Intersection LOS: D
 Intersection Capacity Utilization 89.1%
 ICU Level of Service E
 Analysis Period (min) 15

Splits and Phases: 3: NE 152nd Avenue & NE Padden Parkway

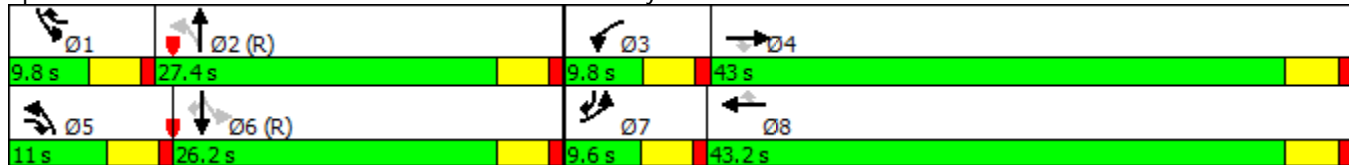

Queues

3: NE 152nd Avenue & NE Padden Parkway

02/13/2019

























Lane Group	EBL	EBT	EBR	WBL	WBT	WBR	NBL	NBT	SBL	SBT	SBR
Lane Group Flow (vph)	37	786	235	88	724	345	42	446	79	55	200
v/c Ratio	0.37	0.98	0.24	0.84	0.90	0.37	0.09	0.92	0.42	0.12	0.29
Control Delay	51.4	53.8	2.0	96.8	39.8	6.7	19.4	60.1	26.7	27.7	4.4
Queue Delay	0.0	0.0	0.0	0.0	0.0	0.0	0.0	0.0	0.0	0.0	0.0
Total Delay	51.4	53.8	2.0	96.8	39.8	6.7	19.4	60.1	26.7	27.7	4.4
Queue Length 50th (ft)	21	427	0	51	371	47	15	247	29	25	0
Queue Length 95th (ft)	52	#678	31	#137	#597	98	37	#427	60	55	44
Internal Link Dist (ft)		1422			1500			816		3326	
Turn Bay Length (ft)	330			215		125	205		315		100
Base Capacity (vph)	101	804	985	105	808	942	460	483	186	449	680
Starvation Cap Reductn	0	0	0	0	0	0	0	0	0	0	0
Spillback Cap Reductn	0	0	0	0	0	0	0	0	0	0	0
Storage Cap Reductn	0	0	0	0	0	0	0	0	0	0	0
Reduced v/c Ratio	0.37	0.98	0.24	0.84	0.90	0.37	0.09	0.92	0.42	0.12	0.29

Intersection Summary

95th percentile volume exceeds capacity, queue may be longer.
 Queue shown is maximum after two cycles.

HCM 2010 Signalized Intersection Summary
 3: NE 152nd Avenue & NE Padden Parkway

02/13/2019

												
Movement	EBL	EBT	EBR	WBL	WBT	WBR	NBL	NBT	NBR	SBL	SBT	SBR
Lane Configurations												
Traffic Volume (veh/h)	37	786	235	88	724	345	42	446	0	79	55	200
Future Volume (veh/h)	37	786	235	88	724	345	42	446	0	79	55	200
Number	7	4	14	3	8	18	5	2	12	1	6	16
Initial Q (Qb), veh	0	0	0	0	0	0	0	0	0	0	0	0
Ped-Bike Adj(A_pbT)	1.00		1.00	1.00		1.00	1.00		1.00	1.00		1.00
Parking Bus, Adj	1.00	1.00	1.00	1.00	1.00	1.00	1.00	1.00	1.00	1.00	1.00	1.00
Adj Sat Flow, veh/h/ln	1881	1881	1881	1881	1881	1881	1900	1900	1900	1863	1863	1863
Adj Flow Rate, veh/h	37	786	235	88	724	345	42	446	0	79	55	200
Adj No. of Lanes	1	1	1	1	1	1	1	1	0	1	1	1
Peak Hour Factor	1.00	1.00	1.00	1.00	1.00	1.00	1.00	1.00	1.00	1.00	1.00	1.00
Percent Heavy Veh, %	1	1	1	1	1	1	0	0	0	2	2	2
Cap, veh/h	102	805	800	106	809	782	460	483	0	209	449	471
Arrive On Green	0.06	0.43	0.43	0.06	0.43	0.43	0.07	0.25	0.00	0.06	0.24	0.24
Sat Flow, veh/h	1792	1881	1599	1792	1881	1599	1810	1900	0	1774	1863	1583
Grp Volume(v), veh/h	37	786	235	88	724	345	42	446	0	79	55	200
Grp Sat Flow(s),veh/h/ln	1792	1881	1599	1792	1881	1599	1810	1900	0	1774	1863	1583
Q Serve(g_s), s	1.8	37.0	7.8	4.4	32.1	12.7	1.5	20.6	0.0	2.9	2.1	9.1
Cycle Q Clear(g_c), s	1.8	37.0	7.8	4.4	32.1	12.7	1.5	20.6	0.0	2.9	2.1	9.1
Prop In Lane	1.00		1.00	1.00		1.00	1.00		0.00	1.00		1.00
Lane Grp Cap(c), veh/h	102	805	800	106	809	782	460	483	0	209	449	471
V/C Ratio(X)	0.36	0.98	0.29	0.83	0.90	0.44	0.09	0.92	0.00	0.38	0.12	0.42
Avail Cap(c_a), veh/h	102	805	800	106	809	782	460	483	0	209	449	471
HCM Platoon Ratio	1.00	1.00	1.00	1.00	1.00	1.00	1.00	1.00	1.00	1.00	1.00	1.00
Upstream Filter(I)	1.00	1.00	1.00	1.00	1.00	1.00	1.00	1.00	0.00	1.00	1.00	1.00
Uniform Delay (d), s/veh	40.9	25.3	13.2	41.9	23.8	15.0	21.7	32.7	0.0	25.4	26.7	25.4
Incr Delay (d2), s/veh	9.8	26.6	0.9	51.0	14.5	1.8	0.4	25.6	0.0	5.2	0.6	2.8
Initial Q Delay(d3),s/veh	0.0	0.0	0.0	0.0	0.0	0.0	0.0	0.0	0.0	0.0	0.0	0.0
%ile BackOfQ(50%),veh/ln	1.2	24.9	3.6	3.7	19.8	6.0	0.8	14.2	0.0	1.7	1.1	4.3
LnGrp Delay(d),s/veh	50.7	51.9	14.1	92.9	38.3	16.8	22.1	58.3	0.0	30.5	27.3	28.2
LnGrp LOS	D	D	B	F	D	B	C	E		C	C	C
Approach Vol, veh/h		1058			1157			488			334	
Approach Delay, s/veh		43.4			36.0			55.2			28.6	
Approach LOS		D			D			E			C	
Timer	1	2	3	4	5	6	7	8				
Assigned Phs	1	2	3	4	5	6	7	8				
Phs Duration (G+Y+Rc), s	9.8	27.4	9.8	43.0	11.0	26.2	9.6	43.2				
Change Period (Y+Rc), s	4.5	4.5	4.5	4.5	4.5	4.5	4.5	4.5				
Max Green Setting (Gmax), s	5.3	22.9	5.3	38.5	6.5	21.7	5.1	38.7				
Max Q Clear Time (g_c+I1), s	4.9	22.6	6.4	39.0	3.5	11.1	3.8	34.1				
Green Ext Time (p_c), s	0.0	0.1	0.0	0.0	0.0	2.8	0.0	3.7				
Intersection Summary												
HCM 2010 Ctrl Delay			40.9									
HCM 2010 LOS			D									

Lanes, Volumes, Timings
4: NE 152nd Avenue & NE 99th Street

02/13/2019



Lane Group	EBL	EBT	EBR	WBL	WBT	WBR	NBL	NBT	NBR	SBL	SBT	SBR
Lane Configurations		↕	↗		↕			↕			↕	
Traffic Volume (vph)	210	88	67	9	22	33	44	560	21	58	220	16
Future Volume (vph)	210	88	67	9	22	33	44	560	21	58	220	16
Ideal Flow (vphpl)	1900	1900	1900	1900	1900	1900	1900	1900	1900	1900	1900	1900
Storage Length (ft)	0		140	0		0	0		0	0		0
Storage Lanes	0		1	0		0	0		0	0		0
Taper Length (ft)	25			25			25			25		
Lane Util. Factor	1.00	1.00	1.00	1.00	1.00	1.00	1.00	1.00	1.00	1.00	1.00	1.00
Frt			0.850		0.930			0.995			0.993	
Flt Protected		0.966			0.993			0.996			0.990	
Satd. Flow (prot)	0	1782	1568	0	1755	0	0	1846	0	0	1868	0
Flt Permitted		0.966			0.993			0.996			0.990	
Satd. Flow (perm)	0	1782	1568	0	1755	0	0	1846	0	0	1868	0
Link Speed (mph)		35			35			35			35	
Link Distance (ft)		8013			3202			3406			4539	
Travel Time (s)		156.1			62.4			66.4			88.4	
Peak Hour Factor	1.00	1.00	1.00	1.00	1.00	1.00	1.00	1.00	1.00	1.00	1.00	1.00
Heavy Vehicles (%)	3%	3%	3%	0%	0%	0%	2%	2%	2%	0%	0%	0%
Adj. Flow (vph)	210	88	67	9	22	33	44	560	21	58	220	16
Shared Lane Traffic (%)												
Lane Group Flow (vph)	0	298	67	0	64	0	0	625	0	0	294	0
Enter Blocked Intersection	No	No	No	No	No	No	No	No	No	No	No	No
Lane Alignment	Left	Left	Right	Left	Left	Right	Left	Left	Right	Left	Left	Right
Median Width(ft)		12			12			12			12	
Link Offset(ft)		0			0			0			0	
Crosswalk Width(ft)		16			16			16			16	
Two way Left Turn Lane												
Headway Factor	1.00	1.00	1.00	1.00	1.00	1.00	1.00	1.00	1.00	1.00	1.00	1.00
Turning Speed (mph)	15		9	15		9	15		9	15		9
Sign Control		Stop			Stop			Stop			Stop	

Intersection Summary

Area Type:	Other
Control Type:	Unsignalized
Intersection Capacity Utilization	66.0%
Analysis Period (min)	15
	ICU Level of Service C

Intersection	
Intersection Delay, s/veh	47.7
Intersection LOS	E

Movement	EBL	EBT	EBR	WBL	WBT	WBR	NBL	NBT	NBR	SBL	SBT	SBR
Lane Configurations		↕	↕		↕			↕			↕	
Traffic Vol, veh/h	210	88	67	9	22	33	44	560	21	58	220	16
Future Vol, veh/h	210	88	67	9	22	33	44	560	21	58	220	16
Peak Hour Factor	1.00	1.00	1.00	1.00	1.00	1.00	1.00	1.00	1.00	1.00	1.00	1.00
Heavy Vehicles, %	3	3	3	0	0	0	2	2	2	0	0	0
Mvmt Flow	210	88	67	9	22	33	44	560	21	58	220	16
Number of Lanes	0	1	1	0	1	0	0	1	0	0	1	0

Approach	EB	WB	NB	SB
Opposing Approach	WB	EB	SB	NB
Opposing Lanes	1	2	1	1
Conflicting Approach Left	SB	NB	EB	WB
Conflicting Lanes Left	1	1	2	1
Conflicting Approach Right	NB	SB	WB	EB
Conflicting Lanes Right	1	1	1	2
HCM Control Delay	21.3	12.1	80.9	17.5
HCM LOS	C	B	F	C

Lane	NBLn1	EBLn1	EBLn2	WBLn1	SBLn1
Vol Left, %	7%	70%	0%	14%	20%
Vol Thru, %	90%	30%	0%	34%	75%
Vol Right, %	3%	0%	100%	52%	5%
Sign Control	Stop	Stop	Stop	Stop	Stop
Traffic Vol by Lane	625	298	67	64	294
LT Vol	44	210	0	9	58
Through Vol	560	88	0	22	220
RT Vol	21	0	67	33	16
Lane Flow Rate	625	298	67	64	294
Geometry Grp	2	7	7	5	2
Degree of Util (X)	1.068	0.64	0.124	0.135	0.54
Departure Headway (Hd)	6.154	7.929	6.847	7.917	6.816
Convergence, Y/N	Yes	Yes	Yes	Yes	Yes
Cap	594	459	527	456	532
Service Time	4.154	5.629	4.547	5.917	4.816
HCM Lane V/C Ratio	1.052	0.649	0.127	0.14	0.553
HCM Control Delay	80.9	23.7	10.5	12.1	17.5
HCM Lane LOS	F	C	B	B	C
HCM 95th-tile Q	18	4.4	0.4	0.5	3.2

EXHIBIT B

MARKET ANALYSIS REPORT



MEMORANDUM

DATE: February 25, 2019
TO: JORDAN RAMIS PC
FROM: JOHNSON ECONOMICS, LLC
SUBJECT: Market Analysis of Current and Prospective Zoning in Clark County, WA

JOHNSON ECONOMICS was hired to conduct an independent assessment of the market feasibility and projected fiscal impacts of employment vs. residential uses on a site in Clark County, Washington. The subject site is under consideration for a change of Comp Plan and zoning designations from commercial use to residential uses.

The subject parcel consists of two taxlots totaling 80 acres, located in unincorporated Clark County, but within the Urban Growth Area (UGA) of the City of Vancouver. The taxlots are currently covered by the Business Park (BP) zone, which is considered an “employment district” and is covered by the Industrial Comprehensive Plan designation.

This analysis considers a proposed change of the Comprehensive Plan designation from Industrial to a mixture of commercial and residential designations. Specifically the new zones would be the Community Commercial (CC) zone and the R1-10 zone (low-density residential).

This analysis considers the suitability of the subject site as a location for business park use vs. commercial/residential use from a market perspective. It also discusses the projected supply and demand for industrial land in the County. The analysis also presents projections of the estimated property valuation and therefore potential tax revenue under both scenarios.

This memo presents the independent methodology and analysis of JOHNSON ECONOMICS and represents best estimates of potential future activity.

- A. Summary of Key Findings 2**
- B. The Subject Site 3**
- C. Development Program Assumptions 5**
- D. Suitability of Site and Location for Candidate Uses..... 8**
- E. Capacity of Employment Land in Vancouver UGA 10**
- F. Property Valuation & Tax Revenue – Scenario 1 vs. Scenario 2 12**
- G. Summary of Estimated Fiscal Impacts 20**

A. SUMMARY OF KEY FINDINGS

As outlined in this memo, our analysis made the following key findings.

- The site is generally physically compatible with either of the development scenarios discussed in this analysis. However, based on market considerations, it seems better suited to a combination of commercial and residential uses given the existing residential nature of the area, the outlying location, and the evident viability of home building in the immediate area. The most feasible complimentary use for residential growth in this area is retail and commercial services to serve the local households.
- In contrast, there is less compelling reason that a large cluster of employment uses must or should be located here. The area does not have ready access to the wider transportation grid for employee commuting and shipping, nor easy access or visibility for deliveries, customers or other visitors. Furthermore, the outlying location will make it difficult for employers there to integrate with a network of other businesses, their suppliers and business services.
- There are not currently complimentary commercial uses such as restaurants and retailers in the immediate area for hundreds of employees to frequent. This would ensure that employees at this site would utilize commercial services 1.5 miles to the west along the highway corridor. This is one reason that office and retail commercial areas are often located adjacent to, or intermingled with each other.
- It seems likely that the development of such a business campus would require significant upgrades and added capacity to NE 152nd, the intersections with 99th and 119th Streets, and perhaps other nearby routes. The cost of these improvements is likely to be a formidable disincentive to speculative business park development of this parcel.
- Given the lack of compelling reason to locate a large employment center in this area, the location is likely to compete poorly with more central employment areas that do not face these challenges.
- These findings indicate that the Vancouver UGA may have a mismatch between the amount of commercial vs. industrial lands that are available, and where future jobs may actually locate. While most remaining land is industrial, employment that tends to use industrial land makes up a much smaller share of the total employment.
- Estimates of potential taxable assessed value (TAV) under the two development scenarios indicate that the total value may be fairly similar, however likely pace of development means that the commercial/residential scenario is projected to grow local tax revenue faster than the business park scenario.

- An important consideration in assessing these land uses at the subject site is also likelihood of development. As discussed in Part D of this report, the market viability of the candidate land uses will vary due to location, visibility, and competition in the area. Therefore, there is also an opportunity cost to preserving this land until a hypothetical business park developer can be identified, if at all. In the meantime, the area generates very modest tax revenue from its current TAV.

B. THE SUBJECT SITE

The subject site is a 79.75-acre parcel located in the northeast corner of the Vancouver UGA. It is located off of NE 152nd Avenue, north of NE 99th Street. The area is mostly characterized by single-family residential housing on three sides, along with legacy rural uses. The parcel directly to the north is also zoned BP.

FIGURE 1: SUBJECT SITE, CLARK COUNTY, WA

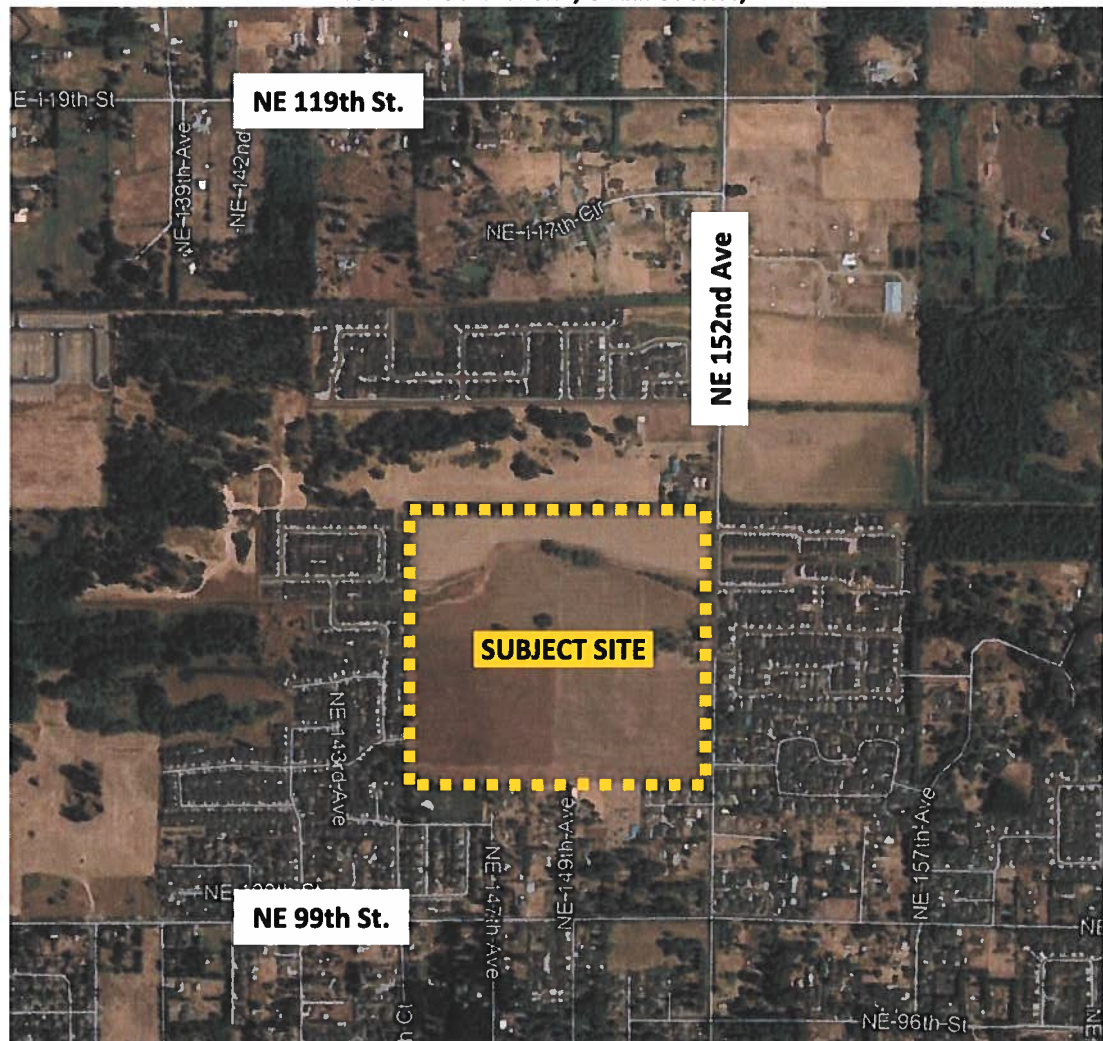

Source: Google Earth, Johnson Economics

The following figure shows the zoning of the parcel and surrounding area. The node of BP zoning that includes the subject parcels is largely surrounded by residential uses.

FIGURE 2: SUBJECT SITE AND AREA ZONING, CLARK COUNTY, WA

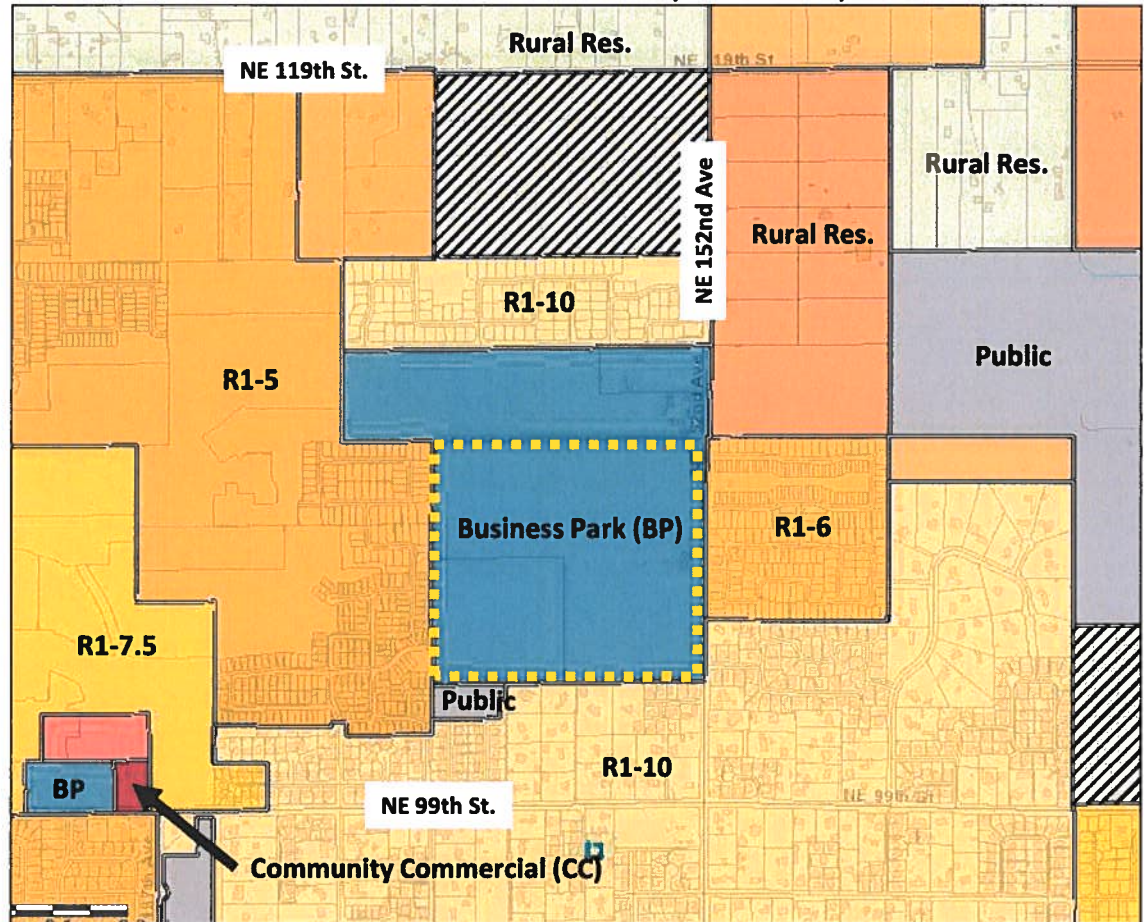

Source: Google Earth, Johnson Economics

The purpose of the Business Park (BP) zone according to the Clark County Unified Development Code is:

The Business Park district provides for the development of uses including limited light manufacturing and wholesale trade, light warehousing, business and professional services, research, business and corporate offices, and other similar compatible or supporting enterprises not oriented to the general public (Chapter 40.230.085)

This stated purpose was used in formulating assumptions of what future business park uses might look like at the subject site under the BP zone, as described in the following section.

It is proposed to change the zoning from employment uses to a mixture of commercial and residential uses. Specifically, the proposed new zones would be the Community Commercial (CC) and R1-10 (low density residential) zones

The CC zone:

These commercial areas are intended to provide for the regular shopping and service needs for several adjacent neighborhoods. This district is only permitted in areas designated as community commercial or mixed use on the comprehensive plan (Chapter 40.230.010)

The R1-10 zone allows a maximum of 4.4 dwelling units per net acre, and is intended to:

- a. *Recognize, maintain and protect established low-density residential areas.*
 - b. *Establish higher densities where a full range of community services and facilities are present or will be present at the time of development.*
 - c. *Provide for additional related uses such as schools, parks and utility uses necessary to serve immediate residential areas.*
- (Chapter 40.220.010)*

This stated purpose was used in formulating assumptions of what future commercial and residential development might look like under these zones, as described in the following section.

C. DEVELOPMENT PROGRAM ASSUMPTIONS

In order to develop estimates of future economic impacts, it was necessary to develop assumptions of the nature of the land use and development of the area as it builds out under the two scenarios: as business park land, or a mixture of commercial and residential land.

Business Park Employment Development (Scenario 1)

Figure 3 presents JOHNSON ECONOMICS estimates of the subject site's holding capacity if built out as a hypothetical business park development. Large business parks of the size of the subject site might contain a mixture of traditional industrial-type space, as well as office-type space.

Industrial space for manufacturing and warehousing typically takes the form of a high-ceiling structure with a large-floorplate and a single-story. Industrial uses are typically surrounded by surface parking and circulation space for truck traffic. Office park space in a suburban environment such as the subject site is typically a two-story professional office form, surrounded by surface parking.

It is assumed for the purposes of this analysis, that the site could house a sizable business park consisting of a mixture of industrial/warehousing use and office use. Using the Clark County growth management standard of 9 jobs per acre of industrial land, the site would hold 574 jobs. [Assumption is from the County Vacant Buildable Lands Model (VLBM).]

The assumption of a business park development meeting these basic parameters underlie the discussion and fiscal analysis presented below.

FIGURE 3: COMMERCIAL RETAIL DEVELOPMENT ASSUMPTIONS, SUBJECT SITE

INDUSTRIAL BUS. PARK SITE AND DEVELOPMENT ASSUMPTIONS		
Site Size (Gross Acres):	79.75 acres	Clark Co. Assessor (2 parcels)
Usable Site (Acres):	63.80 acres	20% loss to ROW or constraints
Usable Site (Square Feet):	2,779,128 sf	
Gross Built Space:	833,738 sf	0.3 FAR for industrial dev.
Leasable Built Space:	833,738 sf	100% efficiency rate for retail space
Estimated # Employees:	574	9 employees/net acres
# of Buildings (Industrial):	10	1-story indust. & warehousing
# of Buildings (Office):	18	2-story prof. office bldgs.

Source: Johnson Economics

Commercial/Residential Development (Scenario 2)

Figures 4 & 5 presents a hypothetical development program for a retail/commercial development on a portion of the site (fronting 152nd Avenue) and a low-density residential development in the remainder of the parcel.

The size of the commercial portion is designed to match the job-creation potential of the business park development (Scenario 1). It is estimated that approximately 45% of the site would be required to accommodate the same number of jobs at 20 jobs/net acre. (This is the assumption applied to commercial land in the Clark County VLBM.)

The commercial portion described in Figure 4 assumes the development of a sizable shopping center serving the surrounding neighborhoods. A shopping center of this size would include one or more big-box or large grocery stores, as well as smaller stores in multiple buildings. This analysis assumes the site would accommodate six multi-tenant buildings of varying sizes. The tenants would be a mix of retail and commercial service businesses.

FIGURE 4: COMMERCIAL DEVELOPMENT ASSUMPTIONS, SUBJECT SITE

COMMERCIAL SITE AND DEVELOPMENT ASSUMPTIONS		
Site Size (Gross Acres):	35.89 acres	Clark Co. Assessor
Usable Site (Acres):	28.71 acres	20% loss to ROW or constraints
Usable Site (Square Feet):	1,250,608 sf	
Gross Built Space:	312,652 sf	0.25 FAR for suburban retail dev.
Leasable Built Space:	312,652 sf	100% efficiency rate for retail space
Estimated # Employees:	574	20 employees/net acres
Estimated # of Buildings:	6	Large, multi-tenant shopping center

Source: Johnson Economics

The residential portion described in Figure 5 assumes that the remainder of the parcel, after the removal of the commercial portion would be used for low-density residential development. In accordance with the R1-10 zone, homes would be developed at a density of one per 10,000 s.f., which amounts to 4.4 units/net acre. This results in an estimate of 152 homes, on 55% of the total available land.

FIGURE 5: RESIDENTIAL DEVELOPMENT ASSUMPTIONS, SUBJECT SITE

RESIDENTIAL SITE DEVELOPMENT ASSUMPTIONS		
Site Size (Gross Acres):	43.86 acres	Clark Co. Assessor
Usable Site (Acres):	35.09 acres	Gross - 20% Street ROW
Usable Site (Square Feet):	1,528,520 sf	
Detached Housing Units:	152 sf	4.4 Units/Net Acre (R1-10 zone)
Average Lot Size:	10,000 sf	Site area/# of Units

Source: Johnson Economics

This is the estimated commercial space and residential unit yield reflected in the discussion and fiscal analysis presented below.

D. SUITABILITY OF SITE AND LOCATION FOR CANDIDATE USES

This section provides an assessment of the subject site as a location for the candidate uses from a market perspective.

General Location

The subject site is located near what is currently the northeast edge of the Vancouver UGA. The current city boundary is located roughly 1.75 miles south of the site, while rural uses located outside of the UGA are located just to the north and northeast of the site.

The subject site fronts on the 152nd Avenue which would likely be the main route of access to new uses on the site. The site is located less than a quarter mile north of NE 99th Street, and 0.5 miles south of NE 119th Street, these being the nearest major east/west routes in the area. The Regional Transportation Plan for 2035 identifies NE 119th Street as part of the "regional highway system." 152nd Ave. is designated as a C-Tran route, to the south of NE 99th Street, however this route turns at 99th and does not include the frontage at the subject site.

2017 traffic counts indicate that 152nd Avenue past the subject site has a traffic count comparable to the stretches of 99th Street and 119th Street in the area. For comparison, the total All Day Traffic (ADT) count of 7,300 vehicles on 152nd north of 99th, is roughly a quarter of the traffic on Highway 503 to the west.

The subject site is located in the midst of relatively recent residential subdivision developments, to the east and west, and to the north (buffered by an additional BP-zoned parcel). There are legacy rural uses in the area, consisting mostly of older homes on large acreage and farm fields.

There are no nearby agglomerations of commercial or employment uses in the area of the subject site. The most significant clusters of these uses are located in the Highway 503 corridor (NE 117th Ave.) roughly 1.5 miles to the west of the subject.

Location for Business Park Use: The location at the northeastern edge of the urban area, at the "gateway" to rural lands is not as ideal for an employment cluster of the size that could hypothetically be accommodated on a site this large.

One challenge for this type of employment cluster at this location is that a large share of on-site employees would likely not live in the immediate area. While employment uses on this scale would certainly provide many job opportunities for local residents as well, it is the nature of large employers that their employees live across a broad commuting shed.

This would make this location less than ideal for a large employer(s) relatively to other more central locations in the metro area, which are served by more major arterials. The population density in this area is insufficient to provide more than a small amount of the employee base for employers of this size.

If the employment user at the subject site is dependent on visibility and accessibility to customers, business partners, or other visitors the location would be less than ideal for similar reasons.

Another current challenge for such a large employment use is that there are not currently complimentary commercial uses such as restaurants and retailers in the immediate area for hundreds of employees to frequent. This would ensure that employees at this site would utilize commercial services 1.5 miles to the west along the highway corridor. This is one reason that office and retail commercial areas are often located adjacent to, or intermingled with each other.

As the area builds out, this location can be expected to be surrounded by low-density residential neighborhoods on all sides. Generally, business park use can be compatible with residential neighborhoods, however, some light-industrial uses might produce negative externalities in the form of noise, dust, truck and delivery traffic, and the like. Traffic capacity for added commuter and truck traffic on nearby arterials will remain a concern.

The intention of the current zoning may be to eventually encourage a very suburban, corporate campus form of development in this area. It seems likely that the development of such a campus would require significant upgrades and added capacity to NE 152nd, the intersections with 99th and 119th Streets, and perhaps other nearby routes. The cost of these improvements is likely to be a formidable disincentive to speculative development of this parcel.

Location for Commercial Use: The isolated location and traffic capacity of nearby arterials present some similar challenges to large retail/commercial use as it does to large employment use. Commercial tenants seek high traffic volumes and high visibility from prospective customers. The site location on NE 152nd Avenue is somewhat isolated, and doesn't feature any corner visibility from 99th or 119th Streets.

However, given the largely residential character of the surrounding area, commercial uses that provide shopping and services to the residents of adjoining neighborhoods will create their own draw that general employment uses will not. A growing need for accessible commercial uses is inherently linked to the build-out of residential neighborhoods.

Currently, the closest clusters of commercial services are over 1.5 miles from the site. The nearest grocery stores are well over two miles away. As this area of the Vancouver UGA fills in with additional households, the subject site would provide a central location to provide more of these types of services within a more accessible distance to these largely residential neighborhoods.

Location for Residential: In general, edge locations in a city are appropriate for residential uses. As evidenced by the amount of housing currently in the area, including many recently developed subdivisions, the location would be suitable for a low-density residential neighborhood.

The scenic rural setting of the surrounding area would likely be seen as a positive for many prospective residents, while Highways 500 and 503 would provide access for commuting to the

greater Vancouver/Portland metro area, and to shopping and services not available in the immediate area.

Topography & Wetlands

It is beyond the scope of the market study to assess the topography and wetland constraints of the parcel, however extensive subdivision development in the area indicates that the area is generally suitable for development of all the candidate uses, though some mitigation may be required.

Finding on Location Suitability

The site is generally physically compatible with either of the development scenarios discussed in this analysis. However, it seems better suited to a combination of commercial and residential uses given the existing residential nature of the area, the outlying location, and the evident viability of home building in the immediate area.

Based on market considerations, the most apparent complimentary use for residential growth in this area is retail and commercial services to serve the local households. In contrast, there is less compelling reason that a large cluster of employment uses must or should be located here. The area does not have ready access to the wider transportation grid for employee commuting and shipping, nor easy access or visibility for deliveries, customers or other visitors. Furthermore, the outlying location will make it difficult for employers there to integrate with a network of other businesses, their suppliers and business services.

Given the lack of compelling reason to locate a large employment center in this area, the location is likely to compete poorly with more central employment areas that do not face these challenges.

E. CAPACITY OF EMPLOYMENT LAND IN VANCOUVER UGA

Figure 6 presents the estimated buildable acres of commercial and industrial land in the Vancouver UGA over the last ten years according to Clark County’s Vacant Buildable Lands Model (VBLM).

FIGURE 6: ESTIMATED BUILDABLE LAND INVENTORY BY LAND USE CATEGORY (VANCOUVER GA)

Land Use	NET ACRES					JOB CAPACITY				Remaining years of supply
	2008	2013	2018	5-Year change	Share (2018)	2008	2013	2018	Share (2018)	
Commercial	1,338	1,024	844	-181	28%	26,754	20,471	16,869	46%	93.5
Industrial	2,037	2,534	2,195	-339	72%	18,335	22,808	19,757	54%	58.3
Totals:	3,375	3,558	3,039	-519	100%	45,089	43,279	36,626	100%	

Source: Clark County Vacant Buildable Lands Model

There are an estimated remaining 3,040 acres of commercial and industrial land in the UGA as of 2018, of which 28% is commercial and 72% is industrial. The job capacity of this land is under 17,000 commercial jobs, and under 20,000 industrial jobs, using the County assumptions of 20 and 9 employees per acre respectively.

Over a five year period, the commercial supply was reduced by 181 acres, while the industrial supply was reduced by 340 acres. At this rate, it is estimated that current buildable supply for both land uses represents many decades of inventory.

Employment by Industry and Land Use

This section provides an estimated breakdown of employment by industry and the type of real estate those industries tend to occupy. The Bureau of Economic Analysis estimates a total of 220k non-farm jobs in the county. Surveys completed by Johnson Economics and Mackenzie engineering firm in the past provide estimates of where these jobs tend to locate by real estate type (see Figure 7).

FIGURE 7: ESTIMATE OF EMPLOYMENT BY REAL ESTATE TYPE

	JOBS	BUILDING TYPE MATRIX					
		Office	Institutional	Flex/B.P	Gen. Ind.	Warehouse	Retail
Construction	17,915	14%	0%	18%	40%	18%	10%
Manufacturing	15,312	8%	0%	24%	60%	8%	0%
Wholesale Trade	8,052	8%	0%	22%	20%	40%	10%
Retail Trade	24,127	5%	1%	6%	0%	12%	76%
Transport., Warehousing, Utilities	6,670	15%	0%	12%	13%	55%	5%
Information	3,675	25%	0%	25%	40%	0%	10%
Finance & Insurance	10,574	72%	1%	5%	1%	1%	20%
Real Estate	12,385	72%	1%	5%	1%	1%	20%
Professional & Technical Services	19,115	72%	1%	5%	1%	1%	20%
Administration Services	11,802	72%	1%	5%	1%	1%	20%
Education	3,057	30%	53%	5%	1%	1%	10%
Health Care	27,630	30%	53%	2%	0%	0%	15%
Leisure & Hospitality	19,348	20%	1%	7%	1%	1%	70%
Other Services	12,709	72%	1%	5%	1%	1%	20%
Government	27,591	43%	35%	5%	1%	1%	15%
TOTAL	219,962	37%	12%	8%	10%	7%	26%

Source: BEA, Johnson Economics, Mackenzie

The averages from the matrix are applied to employment levels to generate an estimate of the number of jobs by real estate type (Figure 8). The table presents estimates of how county jobs are distributed, and a tally (at the bottom) of what type of land use those jobs are likely to occupy. For instance, office jobs are assumed to occupy commercial land, while warehouse jobs are assumed to occupy industrial land.

FIGURE 8: ESTIMATE OF EMPLOYMENT BY REAL ESTATE TYPE

	JOBS	BUILDING TYPE MATRIX						Jobs
		Office	Institutional	Flex/B.P	Gen. Ind.	Warehouse	Retail	
Construction	17,915	2,508	0	3,225	7,166	3,225	1,792	
Manufacturing	15,312	1,225	0	3,675	9,187	1,225	0	
Wholesale Trade	8,052	644	0	1,771	1,610	3,221	805	
Retail Trade	24,127	1,206	241	1,448	0	2,895	18,337	
Transport., Warehousing, Utilities	6,670	1,001	0	800	867	3,669	334	
Information	3,675	919	0	919	1,470	0	368	
Finance & Insurance	10,574	7,613	106	529	106	106	2,115	
Real Estate	12,385	8,917	124	619	124	124	2,477	
Professional & Technical Services	19,115	13,763	191	956	191	191	3,823	
Administration Services	11,802	8,497	118	590	118	118	2,360	
Education	3,057	917	1,620	153	31	31	306	
Health Care	27,630	8,289	14,644	553	0	0	4,145	
Leisure & Hospitality	19,348	3,870	193	1,354	193	193	13,544	
Other Services	12,709	9,150	127	635	127	127	2,542	
Government	27,591	11,864	9,657	1,380	276	276	4,139	
TOTAL	219,962	80,384	27,022	18,606	21,467	15,400	57,084	
Commercial:		80,384	27,022	9,303			57,084	173,792 79%
Industrial:				9,303	21,467	15,400		46,170 21%
Total:		80,384	27,022	18,606	21,467	15,400	57,084	219,962

Source: BEA, Johnson Economics, Mackenzie

These estimates are an imperfect measure, but do indicate a basic pattern that most county jobs (79%) are more likely to place in commercial setting rather than industrial setting (21%).

This is in contrast to the VBLM findings shown in Figure 6 which show available industrial acreage (72%) and job capacity (54%) to be higher than that of commercial lands.

These findings indicate that the Vancouver UGA may have a mismatch between the amount of commercial vs. industrial lands that are available, and where future jobs may actually locate. While most remaining land is industrial, employment that tends to use industrial land makes up a much smaller share of the total employment.

F. PROPERTY VALUATION & TAX REVENUE – SCENARIO 1 vs. SCENARIO 2

This section presents projections of future potential property valuation and revenues from property taxes resulting from the two alternative development scenarios presented in Section C of this report.

It is difficult to anticipate all contingencies that might impact the development timeline. Because of this, we try to use straightforward assumptions which do not overcomplicate the

analysis or attempt to predict the future in more detail than is practical. The development parameters outlined here are hypothetical and subject to change.

Because of the large size of this site, this analysis assumes that both scenarios are built out over a multi-year period.

For reference the development assumptions are reproduced below:

FIGURE 9: BUSINESS PARK DEVELOPMENT ASSUMPTIONS, SUBJECT SITE

INDUSTRIAL BUS. PARK SITE AND DEVELOPMENT ASSUMPTIONS		
Site Size (Gross Acres):	79.75 acres	Clark Co. Assessor (2 parcels)
Usable Site (Acres):	63.80 acres	20% loss to ROW or constraints
Usable Site (Square Feet):	2,779,128 sf	
Gross Built Space:	833,738 sf	0.3 FAR for industrial dev.
Leasable Built Space:	833,738 sf	100% efficiency rate for retail space
Estimated # Employees:	574	9 employees/net acres
# of Buildings (Industrial):	10	1-story indust. & warehousing
# of Buildings (Office):	18	2-story prof. office bldgs.

Source: Johnson Economics

FIGURE 10: RETAIL/COMMERCIAL DEVELOPMENT ASSUMPTIONS, SUBJECT SITE

COMMERCIAL SITE AND DEVELOPMENT ASSUMPTIONS		
Site Size (Gross Acres):	35.89 acres	Clark Co. Assessor
Usable Site (Acres):	28.71 acres	20% loss to ROW or constraints
Usable Site (Square Feet):	1,250,608 sf	
Gross Built Space:	312,652 sf	0.25 FAR for suburban retail dev.
Leasable Built Space:	312,652 sf	100% efficiency rate for retail space
Estimated # Employees:	574	20 employees/net acres
Estimated # of Buildings:	6	Large, multi-tenant shopping center

Source: Johnson Economics

FIGURE 11: RESIDENTIAL DEVELOPMENT ASSUMPTIONS, SUBJECT SITE

RESIDENTIAL SITE DEVELOPMENT ASSUMPTIONS		
Site Size (Gross Acres):	43.86 acres	Clark Co. Assessor
Usable Site (Acres):	35.09 acres	Gross - 20% Street ROW
Usable Site (Square Feet):	1,528,520 sf	
Detached Housing Units:	152 sf	4.4 Units/Net Acre (R1-10 zone)
Average Lot Size:	10,000 sf	Site area/# of Units

Source: Johnson Economics

Economic Assumptions: This analysis uses the most current figures and factors identified during the analysis, which are generally from 2018. Because future changes to these factors are difficult to predict, this analysis applies the current figures to the coming years. For instance, this analysis applies the current taxing rates of the applicable taxing jurisdictions, and results are presented in 2018 dollars.

All of the figures presented here are estimates. Though the model used generates results in precise dollar figures, results should be considered indicators of the potential scale of future impacts, and not precise predictions.

BUSINESS PARK DEVELOPMENT FISCAL FORECAST (SCENARIO 1)

It is estimated for the purposes of this analysis, that the site could house a sizable business park consisting of a mixture of industrial/warehousing use and office use. Industrial buildings tend to be one-story buildings with high ceilings and a large floorplate. Suburban office buildings tend to have a smaller floorplate but two to three stories. All buildings are assumed to be served by surface parking lots.

Based on the preliminary development program we estimate a potential \$145 million of *new* assessed value over the build-out period. With annual escalation, TAV is estimated to build to a forecasted \$171 million over the ten-year period. (Figure 12)

FIGURE 12: BUSINESS PARK DEVELOPMENT TAXABLE ASSESSED VALUE (TAV) PROJECTIONS

Development Phases	# of Retail Bldgs	Est. Avg. Assessed Value	Est. Total TAV (Annual)	Cummulative Units	Est. Total TAV (Cumulative)*
<u>Commercial</u>					
Year 1	4	\$5,145,357	\$20,581,000	4	\$20,581,000
Year 2	4	\$5,145,357	\$20,581,000	8	\$41,779,000
Year 3	4	\$5,145,357	\$20,581,000	12	\$63,613,000
Year 4	4	\$5,145,357	\$20,581,000	16	\$86,102,000
Year 5	3	\$5,145,357	\$15,436,000	19	\$104,121,000
Year 6	3	\$5,145,357	\$15,436,000	22	\$122,681,000
Year 7	3	\$5,145,357	\$15,436,000	25	\$141,797,000
Year 8	3	\$5,145,357	\$15,436,000	28	\$161,487,000
Year 9	0	\$5,145,357	\$0	28	\$166,332,000
Year 10	0	\$5,145,357	\$0	28	\$171,322,000
TOTAL:	28		\$144,068,000	28	\$171,322,000

* Assumes assessed value grows at an avg. annual rate of 3%.

Source: Johnson Economics, Clark County

Figure 13 (next page) applies the TAV estimates shown above to the relevant taxing jurisdictions, under the current Tax Code 119082.

Figure 13 shows the list of taxing jurisdictions in this tax code, and the tax rate which applies to each of them. Tax rates were applied to the estimated total TAV in each year to estimate the annual revenue for each jurisdiction.

For the sake of space, this table presents estimates for Year 1, Year 10, and the 10-Year total.

Findings:

- As Figure 13 shows, the business park development program at the subject site could generate an estimated \$8.3 million in new property tax revenue over the ten year period.
- By the stabilized Year 11, the annual tax revenue is estimated to be \$1.37 million.

**FIGURE 13: ESTIMATED ANNUAL PROPERTY TAX GENERATION, BY RECIPIENT
BUSINESS PARK DEVELOPMENT SCENARIO 1**

<u>Taxing District</u>	<u>Tax Rate per \$1,000 AV</u>	<u>Share of Total Rate</u>	<u>Year 1</u>	<u>Year 10</u>	<u>10-Year Total</u>	<u>Year 11 Stabilized</u>
ESTIMATED TOTAL ASSESSED VALUE:			\$20,581,000	\$171,322,000	\$1,079,815,000	\$177,318,270
<u>Tax Code: 119082</u>						
Clark County - General	0.9805015382	11.2%	\$20,180	\$167,981	\$1,058,760	\$173,861
Clark County - Dev. Disability	0.0114738818	0.1%	\$236	\$1,966	\$12,390	\$2,035
Clark County - Mental Health	0.0114738818	0.1%	\$236	\$1,966	\$12,390	\$2,035
Clark County - Veterans Asst.	0.0103264867	0.1%	\$213	\$1,769	\$11,151	\$1,831
Clark County - Conservation	0.0390985748	0.4%	\$805	\$6,698	\$42,219	\$6,933
Roads (Clark County)	1.3780905430	15.7%	\$28,362	\$236,097	\$1,488,083	\$244,361
School District 119	0.6059437755	6.9%	\$12,471	\$103,811	\$654,307	\$107,445
School District 119 (2)	1.5000000000	17.1%	\$30,872	\$256,983	\$1,619,723	\$265,977
Library	0.3635801481	4.1%	\$7,483	\$62,289	\$392,599	\$64,469
Parks (Greater Clark)	0.1805433984	2.1%	\$3,716	\$30,931	\$194,953	\$32,014
Fire District 05	1.1825702276	13.5%	\$24,338	\$202,600	\$1,276,957	\$209,691
State of Wash. - State Schools	2.5060357234	28.6%	\$51,577	\$429,339	\$2,706,055	\$444,366
EST. TOTAL PROP. TAX REVENUE:	8.7696381793	100.0%	\$158,819	\$1,322,051	\$8,332,677	\$1,368,323

Source: Johnson Economics, Clark County

COMMERCIAL/ RESIDENTIAL DEVELOPMENT FISCAL FORECAST (SCENARIO 2)

Commercial Portion: This analysis assumes that the commercial portion of development Scenario 2 consists of a sizable shopping center serving the surrounding neighborhoods. A shopping center of this size would include one or more big-box or large grocery stores, as well as smaller stores in multiple buildings. This analysis assumes the site would accommodate six multi-tenant buildings of varying sizes. The tenants would be a mix of retail and commercial service businesses.

Based on the preliminary development program we estimate a potential \$70.9 million of new assessed value in the commercial portion over the build-out period. With annual escalation, TAV is estimated to build to a forecasted \$91.1 million over the ten-year period. (Figure 14)

FIGURE 14: COMMERCIAL DEVELOPMENT TAXABLE ASSESSED VALUE (TAV) PROJECTIONS

Development Phases	# of Retail Bldgs	Est. Avg. Assessed Value	Est. Total TAV (Annual)	Cumulative Units	Est. Total TAV (Cumulative)*
Commercial					
Year 1	3	\$11,811,300	\$35,434,000	3	\$35,434,000
Year 2	3	\$11,811,300	\$35,434,000	6	\$71,931,000
Year 3	0	\$11,811,300	\$0	6	\$74,089,000
Year 4	0	\$11,811,300	\$0	6	\$76,312,000
Year 5	0	\$11,811,300	\$0	6	\$78,601,000
Year 6	0	\$11,811,300	\$0	6	\$80,959,000
Year 7	0	\$11,811,300	\$0	6	\$83,388,000
Year 8	0	\$11,811,300	\$0	6	\$85,890,000
Year 9	0	\$11,811,300	\$0	6	\$88,467,000
Year 10	0	\$11,811,300	\$0	6	\$91,121,000
TOTAL:	6		\$70,868,000	6	\$91,121,000

* Assumes assessed value grows at an avg. annual rate of 3%.

Source: Johnson Economics, Clark County

Residential Portion: Given the remaining net buildable acreage after the commercial portion is accounted for, Scenario 2 assumes 152 single family homes built in the subject site area over 8 years, or 20 per year and 12 in the final year. The average assumed market value is \$460,000 per home which is the median home sale price in the area over the last two years, for homes on lots of 10k sq.ft. or more.

Based on the preliminary development program we estimate a potential \$69.9 million of *new* assessed value over the build-out period. After annual escalation, the TAV builds to a forecasted \$85.3 million in accumulated TAV over the ten-year period.

FIGURE 15: RESIDENTIAL DEVELOPMENT TAXABLE ASSESSED VALUE (TAV) PROJECTIONS

Development Phases	# of Units	Est. Avg. Assessed Value	Est. Total TAV (Annual)	Cummulative Units	Est. Total TAV (Cumulative)*
<u>Residential</u>					
Year 1	20	\$460,000	\$9,200,000	20	\$9,200,000
Year 2	20	\$460,000	\$9,200,000	40	\$18,722,000
Year 3	20	\$460,000	\$9,200,000	60	\$28,577,000
Year 4	20	\$460,000	\$9,200,000	80	\$38,777,000
Year 5	20	\$460,000	\$9,200,000	100	\$49,334,000
Year 6	20	\$460,000	\$9,200,000	120	\$60,261,000
Year 7	20	\$460,000	\$9,200,000	140	\$71,570,000
Year 8	12	\$460,000	\$5,520,000	152	\$79,595,000
Year 9	0	\$460,000	\$0	152	\$82,381,000
Year 10	0	\$460,000	\$0	152	\$85,264,000
TOTAL:	152		\$69,920,000	152	\$85,264,000

* Assumes assessed value grows at an avg. annual rate of 3%.

Source: Johnson Economics, Clark County

Figure 16 (following page) applies the TAV estimates shown above to the relevant taxing jurisdictions, under the current Tax Code 119082. *The following table show the estimated tax revenue for the combined commercial and residential portions.*

Figure 16 shows the list of taxing jurisdictions in this tax code, and the tax rate which applies to each of them. Tax rates were applied to the estimated total TAV in each year to estimate the annual revenue for each jurisdiction. For the sake of space, this table presents estimates for Year 1, Year 10, and the 10-Year total.

**FIGURE 16: ESTIMATED ANNUAL PROPERTY TAX GENERATION, BY RECIPIENT
COMMERCIAL/RESIDENTIAL DEVELOPMENT SCENARIO 2**

<u>Taxing District</u>	<u>Tax Rate per \$1,000 AV</u>	<u>Share of Total Rate</u>	<u>Year 1</u>	<u>Year 10</u>	<u>10-Year Total</u>	<u>Year 11 Stabilized</u>
ESTIMATED TOTAL ASSESSED VALUE:			\$44,634,000	\$176,385,000	\$1,289,873,000	\$182,558,475
<u>Tax Code: 119082</u>						
Clark County - General	0.9805015382	11.2%	\$43,764	\$172,946	\$1,264,722	\$178,999
Clark County - Dev. Disability	0.0114738818	0.1%	\$512	\$2,024	\$14,800	\$2,095
Clark County - Mental Health	0.0114738818	0.1%	\$512	\$2,024	\$14,800	\$2,095
Clark County - Veterans Asst.	0.0103264867	0.1%	\$461	\$1,821	\$13,320	\$1,885
Clark County - Conservation	0.0390985748	0.4%	\$1,745	\$6,896	\$50,432	\$7,138
Roads (Clark County)	1.3780905430	15.7%	\$61,510	\$243,075	\$1,777,562	\$251,582
School District 119	0.6059437755	6.9%	\$27,046	\$106,879	\$781,591	\$110,620
School District 119 (2)	1.5000000000	17.1%	\$66,951	\$264,578	\$1,934,810	\$273,838
Library	0.3635801481	4.1%	\$16,228	\$64,130	\$468,972	\$66,375
Parks (Greater Clark)	0.1805433984	2.1%	\$8,058	\$31,845	\$232,878	\$32,960
Fire District 05	1.1825702276	13.5%	\$52,783	\$208,588	\$1,525,365	\$215,888
State of Wash. - State Schools	2.5060357234	28.6%	\$111,854	\$442,027	\$3,232,468	\$457,498
EST. TOTAL PROP. TAX REVENUE:	8.7696381793	100.0%	\$344,430	\$1,361,121	\$9,953,645	\$1,408,761

Source: Johnson Economics, Clark County

Findings:

- As Figure 16 shows, the commercial/residential development program at the subject site could generate an estimated \$9.9 million in new property tax revenue over the ten year period.
- By the stabilized Year 11, the annual tax revenue is estimated to be \$1.4 million.

G. SUMMARY OF ESTIMATED FISCAL IMPACTS

The preceding section presents fiscal revenue projections from the two candidate land uses: business park employment, or commercial/residential mix. A comparison of these impacts is presented below:

**FIGURE 17: COMPARISON OF ESTIMATED TAX REVENUE GENERATION
DEVELOPMENT SCENARIOS**

	Scenario 1	Scenario 2			Scenario 1 / Scenario 2
	Indust. Bus. Park BP Development	Retail/Comm. CC Development +	Single Fam. Resid. R1-10 Dev. =	Scenario 2 Combined	
Current Subject Site TAV:	\$95,280			\$95,280	
Cummulative 10-Year TAV:	\$1,079,815,000	\$766,192,000 +	\$523,681,000 =	\$1,289,873,000	84%
Year 11 "Stabilized" TAV:	\$177,318,270	\$94,310,235 +	\$88,248,240 =	\$182,558,475	97%
<i>10-Year Prop. Tax Revenue:</i>	<i>\$8,332,600</i>	<i>\$5,912,700 +</i>	<i>\$4,041,200 =</i>	<i>\$9,953,900</i>	<i>84%</i>

Source: Johnson Economics

- Of the two scenarios modeled, the Commercial/Residential Scenario 2 is anticipated to have the greatest total fiscal impact over the 10-year period from tax generation.
- Scenario 1 is expected to generate 84% of the cumulative TAV over a ten year period, and a similar smaller amount of revenue. By Year 11 the total TAV is expected to be nearly equal, however the Scenario 1 TAV remains a bit smaller.
- Over the ten year period, estimated cumulative tax revenue is expected to be \$8.3 million under Scenario 1 and \$9.9 million under Scenario 2.

Other Revenue Considerations

An important consideration in assessing these land uses at the subject site is also likelihood of development. As discussed in Part D of this report, the market viability of the candidate land uses will vary due to location, visibility, and competition in the area. Therefore, there is also an opportunity cost to preserving this land until a hypothetical business park developer can be identified, if at all. In the meantime, the area generates very modest tax revenue from its current TAV.



MEMORANDUM

DATE: March 30, 2019
 TO: JORDAN RAMIS PC
 FROM: JOHNSON ECONOMICS, LLC
 SUBJECT: Market Analysis of Current and Prospective Zoning in Clark County, WA

MARKET ANALYSIS SUPPLEMENT

JOHNSON ECONOMICS was hired to conduct an independent assessment of the market feasibility and projected fiscal impacts of employment vs. residential uses on a site in Clark County, Washington.

This memo is a supplement to the market analysis report dated 2/25/19. That memo assumed that the rezoned land would consist of 35.9 acres of Community Commercial land and 43.9 acres of low-density residential land. This assumption was designed so that the estimated employment that could be accommodated in the commercial zone, matched the estimated employment that could be accommodated under the existing Business Park zone.

In practice, the amount of commercial land in the rezoned scenario is likely to be less than 35.9 acres. This supplemental memo presents the results of a secondary analysis that assumes that the commercial component will be 10 acres. The residential portion will be a greater 69.8 acres.

This change would have the following estimated impacts on the metrics discussed in the detailed memo. (Please see the 2/25 memo for discussion of methodology.)

**FIGURE 1: COMMERCIAL LAND (36 ACRES VS. 10 ACRES)
 UNDER THE ZONE CHANGE SCENARIO**

	35.9 Acres Commercial (Prior)	10 Acres Commercial (New)
Acres:	35.9	10
Net Acres:	28.7	8
Comm. Buildings:	6	3
Job Capacity:	574	160
Residential Acres:	43.9	69.8
Housing Units:	152	243
Commercial TAV:*	\$91.1 mil	\$30.9 mil
Residential TAV:*	\$85.3 mil	\$131.3 mil
Total TAV:*	\$176.4 mil	\$162.2 mil

Source: Google Earth, Johnson Economics
 * TAV = Taxable Assessed Value, at full build-out

As Figure 1 shows the impact of programming a lesser amount of commercial acreage is estimated to reduce the employment capacity and the commercial TAV. At the same time, the residential portion would grow, resulting in more housing and higher residential TAV. Overall, the new scenario results in somewhat lesser total TAV.

The methodology used to generate these estimates are the same used in the 2/25 memo. That memo provides greater detail on approach and methodology while also discussing the build-out scenario under the current Business Park zoning.

EXHIBIT C

MAP OF VACANT INDUSTRIAL LAND

EXHIBIT D

**EXCERPT FROM 12/13/16
PRE-APP CONFERENCE REPORT**



Pre-Application
Conference
Final Report

Project Name:	Riverview Asset
Case Number:	PAC2016-00159
Location:	10512 NE 152 nd Ave
Parcel Number(s):	200326000; 200355000
Site Size:	69.55 acres
Request:	A request to amend the Comprehensive Plan and Zoning Maps from Industrial (Business Park (BP) to UL (R1-6)
Applicant:	James Howsley 1499 SE Tech Center Place, Ste. 380 Vancouver, WA 98683 P: (360) 567-3900 Jamie.howsley@jordanramis.com
Contact Person:	Kristin French 1499 SE Tech Center Place, Ste. 380 Vancouver, WA 98683 P:(360) 567-3900 kristin.french@jordanramis.com
Property Owner:	Riverview Asset Management & Trust et. al. Trustees c/o Dempsey Family Trust 900 Washington St., Ste. 900 Vancouver, WA 98660

DATE OF CONFERENCE: December 13, 2016

STAFF CONTACT: Jose Alvarez, Clark County Annual Review Coordinator
(360) 397-2280 – ext. 4898 annual.review@clark.wa.gov

PRESENT AT CONFERENCE:

Name	Contact Information
Jose Alvarez	Clark County Community Development (see above)
Laurie Lebowsky	Clark County Community Planning (Transportation) (360) 397-2375 – ext. 4544

Disclaimer: The following is a brief summary of issues and requirements that were identified at the pre-application conference based on the information provided by the applicant. This summary may contain supplemental information which was not discussed in the conference and is intended to aid the applicant in preparing a complete Annual Review application and/or to provide the applicant with additional information regarding the subject site. Staff responses and information contained in this pre-application report are preliminary in nature, and do not constitute an approval or denial. The determinations contained in this report were based upon information submitted by the applicant, and may be subject to change upon further examination or in light of new or revised information contained in the formal application.

The following materials were provided by the applicant and were reviewed by Clark County staff in advance of the pre-application conference:

- Application forms
- Narrative
- GIS Packet

BACKGROUND

The applicant proposes to amend the comprehensive plan and rezone approximately 60(?) acres from Industrial designation with Business Park zone to Urban Low designation with an R1-6 zone.

SUMMARY

The following comments and issues were discussed or identified during the pre-application meeting held on December 13, 2016.

Land Use

Comments provided by Clark County Long Range Planning, Jose Alvarez:

Staff provided an overview of how the pre-application conference would be conducted and a summary of what information would be covered. Staff also provided information regarding Clark County's obligation to plan under the State's Growth Management Act and the long-range, comprehensive planning exercise that concluded in 1994 with the adoption of the 20-Year Comprehensive Growth Management Plan and corresponding zone map. In 2004, 2007 and 2016 the County adopted an updated 20-Year Comprehensive Plan and zone map.

Specific to this application, staff stated that the assumption is that the current comprehensive plan and zone designation (Industrial, (BP)) was still applicable to this area and that the applicant will need to demonstrate that a change to a residential zone is appropriate and consistent with the County's Growth Management Plan and Unified Development Code. Staff said that the proposal to change the designation will need to be consistent with the Growth Management Act and the county-wide planning policies, (Growth Management Plan). Staff proceeded to discuss with the applicant the Comprehensive Plan Designation Map Change Criteria that the applicant will need to address in an application.

Staff mentioned that the property now owned by the Battle Ground School district would make sense to be added to the request in order to not leave an isolated pocket of Business Park zoned land, the same would be true for the property to the north of the site.

Staff mentioned that the R1-10 zone is probably not appropriate if the idea is to provide more affordable housing. Staff also noted that the concentration of residential development may need to be broken up with some commercial along the frontage of NE 152nd. Staff suggested the applicant may want to address the loss of job producing land or potential alternatives.

The applicant asked if there was some flexibility in proposing different zones on the property. Staff responded that there was some flexibility either before submittal or shortly thereafter, so that a review could be done in a timely manner.

Transportation



Proposed Plan Map

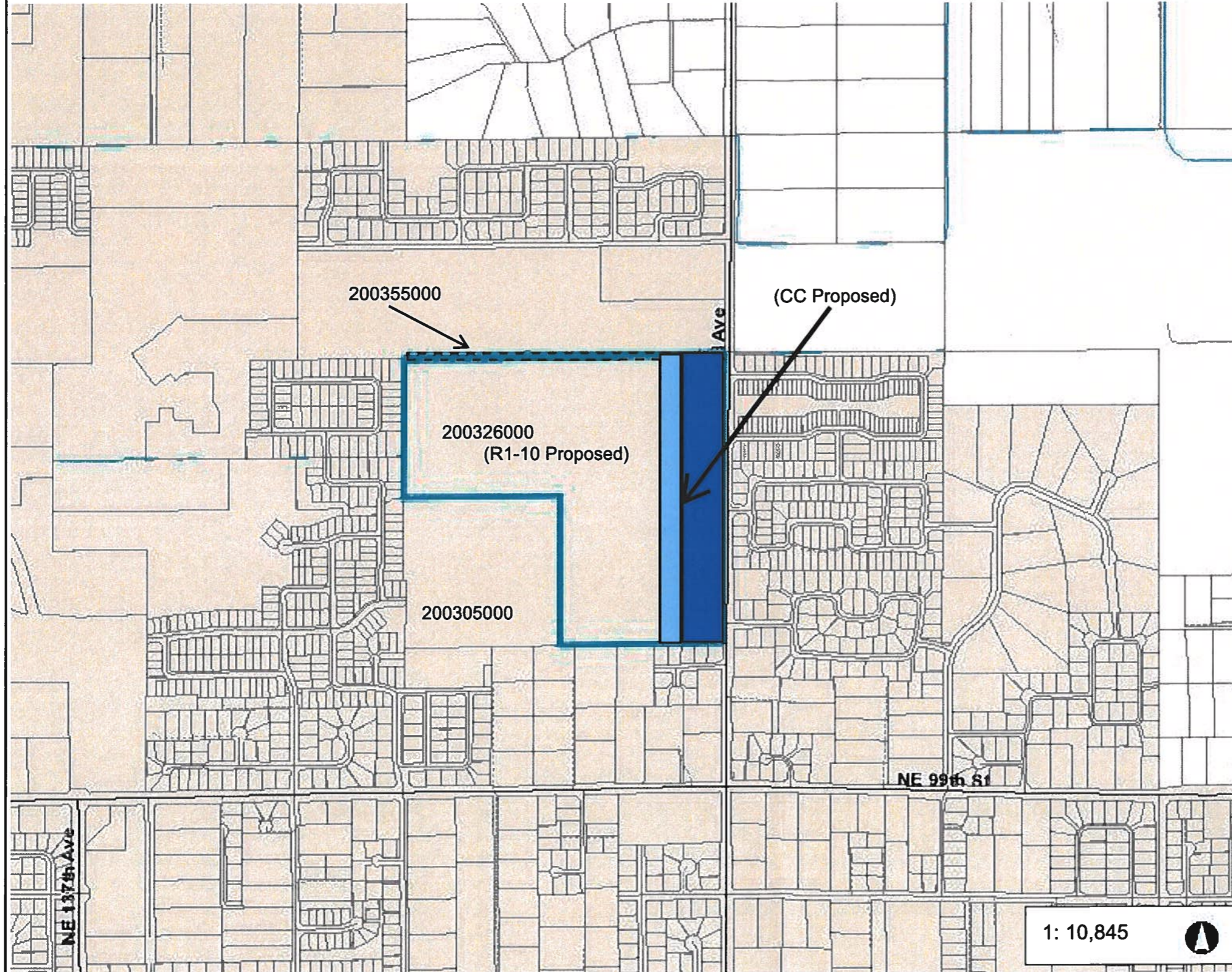
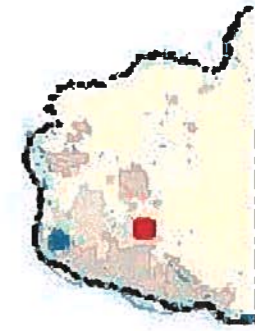

Legend

- Taxlots
- Cities Boundaries
- Urban Growth Boundaries

- Approx. 7 acres
- Approx. 3 acres

Notes:

1: 10,845

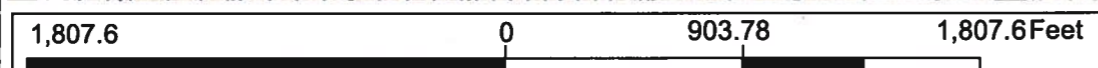

WGS_1984_Web_Mercator_Auxiliary_Sphere
Clark County, WA. GIS - <http://gis.clark.wa.gov>

This map was generated by Clark County's "MapsOnline" website. Clark County does not warrant the accuracy, reliability or timeliness of any information on this map, and shall not be held liable for losses caused by using this information.

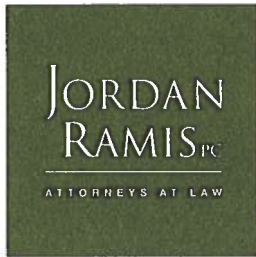

1499 SE Tech Center Place, Ste. 380
Vancouver, WA 98683

Tel. (360) 567-3900
Fax (360) 567-3901

www.jordanramis.com

Armand Resto-Spotts
armand.resto-spotts@jordanramis.com
Direct Dial: (360) 567-3917

June 6, 2019

Clark County Planning Commission
ATTN: Jose Alvarez
Clark County
P.O. Box 9810
Vancouver, WA 98666-9810

Re: **CPZ2019-00003 Riverview Asset Annual Review**
Response to comments to Planning Commission

Dear Planning Commission:

This letter, submitted on behalf of the Applicant for the above-referenced annual review application, provides a brief response to the comment letters submitted in regards to the annual review request. This letter is not a response to the staff report for this application, and Applicant intends to provide that response before the Planning Commission's public hearing on June 20, 2019.

With respect to the Nisqually Indian Tribe comment, a cultural resource survey and inadvertent discovery plan are premature at this stage, and with any future development proposal on the Site, the respective future applicant will proceed with any required archeological studies as required in the review process.

With respect to the CREDC comment, we appreciate that the CREDC recognizes that Applicant has modified their proposal from 2017 in order to better accommodate City Council's requests for some commercial piece on the Site and provide a mix of uses for the neighborhood. However, Applicant emphasizes that the Site is not appropriate for the Industrial designation and Business-Park zoning. It has not developed for nearly two decades, and the vast majority of incoming industrial and job-producing land will be coming in the 179th Avenue area, which will include the necessary infrastructure and transportation grid to develop. The Applicant's Site is not convenient for industrial transportation purposes, given its lack of immediate access to the wider grid and its outlying location. Further, given the lack of commercial uses in the immediate area, if there were ever "employees" on this site, they would need to travel nearly two miles away to access such commercial amenities, which means more transportation impacts and possible needs to upgrade and improve NE 152nd Avenue and the 99th St. intersection. Evidenced by its lack of interest over the many years, the Applicant's Site is a poor option for industrial/job-producing land. Conversion of the Site to residential and commercial is entirely warranted and consistent with the surrounding area.

With respect to the Yeisleys' comment¹, their references to other housing developments has no impact on the proposed conversion from Industrial to Residential and Commercial. In fact, one of the primary reasons Applicant has provided throughout this process in support of the annual review application is that industrial land is wholly incompatible and inappropriate in this neighborhood of mostly residential land. We have incorporated a commercial aspect, in order to serve these residential properties.

The Yeisleys take further issue with the transportation and traffic impacts in the area. Ironically, however, the traffic impacts that the Yeisleys wish to reduce would be exacerbated if this property were in fact developed as a business park. Finally, the Yeisleys' comment on preserving open space is misplaced in this instance. The Applicant's site is vacant industrial land, not open space.

Thank for the opportunity to provide a response.

Very truly yours,

JORDAN RAMIS PC



Armand Resto-Spotts

¹ Interestingly, the Yeisleys' phone number provided is a (714) area code, which includes the Anaheim, California area. The property records indicate they purchased their home in 2016. In reviewing the Yeisleys' comments, especially regarding the "flooded" housing mark, the lack of a "need for additional housing," and whether any "action towards widening the roads...is even possible," the Planning Commission should consider their apparent short-term residency thus far in the area.